

KERN - Tradition and Innovation for over 170 years

An independent family business, KERN since already 7 generations is synonymous with quality and reliability in customer service.

fast

- 24 hours delivery service – ordered today, on its way tomorrow
- Sales & service hotline available from 8:00 am to 6:00 pm

reliable

- 3 years warranty for balances over € 400,-
- Precision in weighing technology for more than 170 years

competent

- DAkkS accreditation DIN EN ISO/IEC 17025
- Certified QM system DIN EN ISO 9001:2008
- Authorisation for initial verification by the manufacturer 2009/23/EC
- Medical certifications DIN EN ISO 13485 and 93/42/EEC

versatile

- One-stop shopping: from pocket balances through to floor scales – everything from one supplier
- Find the product you want at lightning speed with the “Balance Quick-Finder” at www.kern-sohn.com

Order hotline
+49 [0] 7433 9933-0

Online-Shop
www.kern-sohn.com

Our team of consultants will assist you
from Monday to Friday
from 8:00 am to 6:00 pm

Service hotline
+49 [0] 7433 9933-199

E-mail order
info@kern-sohn.com

www.kern-sohn.com
For product specification sheets, user manuals, useful information, technical glossary pictures and much more as well as a smart search engine for test weights and balances

Calibration hotline
+49 [0] 7433 9933-196

Fax Order
+49 [0] 7433 9933-146

KERN & SOHN GmbH
Balances, Test weights, DAkkS Calibration laboratory
Ziegelei 1
72336 Balingen
Germany

Tel. +49 [0] 7433 9933-0
Fax +49 [0] 7433 9933-149

info@kern-sohn.com
www.kern-sohn.com

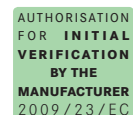
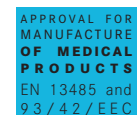

2016

Printed in Germany by KERN & SOHN GmbH z-cb-gb-pp-20161

GB

BALANCES & TEST SERVICE – for laboratory, industry and food

GB



BALANCES & TEST SERVICE

for laboratory, industry and food

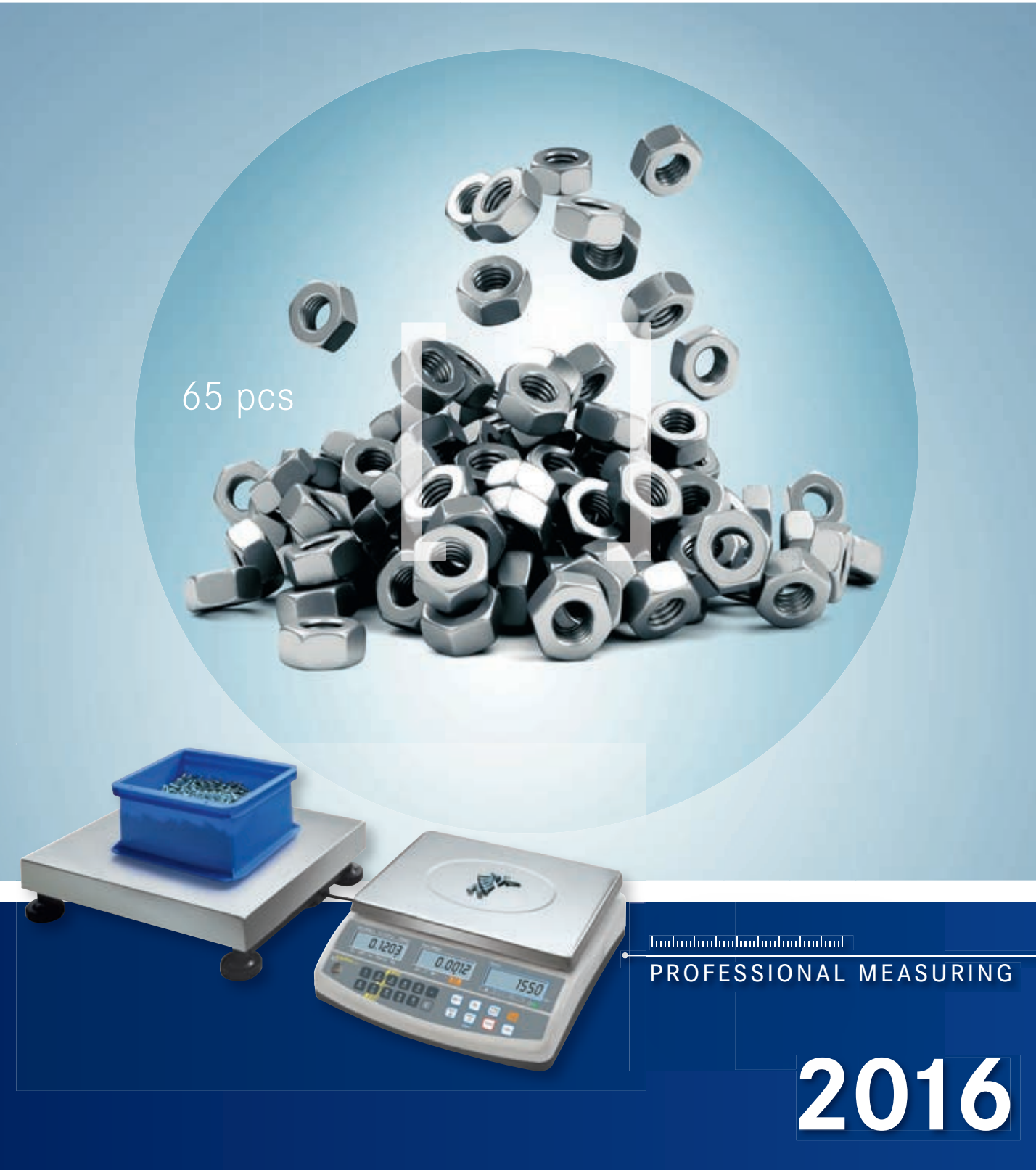

PROFESSIONAL MEASURING

2016

How do I quickly find the product I am looking for?

The tried and tested quick search system – “Quick-Finder” ahead of each product group allows you to base the search for a certain target group on weighing data you need such as readout, weighing range and main features for each model.

And it's as simple as that – find the product you want in 2 steps:

1. Go to the product group index on page 3
2. Pick the appropriate product group and find the product you want using the Quick-Finder.

... or use the model name and find the product quickly and efficiently using the A-Z model list:

KERN Models A – Z

440	22	FKT	70/71	O	
572/573	30	FKTF	170/171	OEX	174
A		FOB-S	74	P	
ABJ-NM/ABS-N	47	FOB	75	PBJ/PBS	38/39
ABT	49	FOB-NS	76	PCB	20/21
ADB	45	FOB-N	77	PCD	19
AEJ-CM/AES-C	48	FXN	80	PEJ/PES	40
AET	50/51	G		PET	41-43
ALJ-A/ALS-A	46	GAB-N	67	PFB	23
B		GAB-P	68	PKS	26/27
BAN	130	H		PKT	34/35
BBB	129	HCB/HCN	162	PLE-N	24
BBN	132	HDB-N/CH	161	PLJ-C/PLJ-G	33
BFA	128	HFA	163	PLJ/PLS	31
BFB	125	HFB	165	PNJ/PNS	32
BFN	131	HFC	164	R	
BFS	127	HFM/HFO	166	RPB	84
BXS	126	HFT	168	S	
C		HTS	167	SFB/SFB-H	81
CCP	100/101	I		SFE	115
CCS	98/99	IEX	173	SMT	175
CCT	102/103	IFB	112/113	SXS	82
CDS	94	IFS	93	T	
CFS	91	IKT	118/119	TAB/TCB/TEE	10
CKE	92	ILJ-C/ILS-C	122	U	
CM/CM-C	10	ILT	120/121	UFA	133
CPB	90	IXS	116/117	UFB	134
CXB/CXB-NM	89	K		UFC	135
D		KB-N/KB-NM/KBJ	25	UFN	136
DAB	54	KEN-TM	149	V	
DBS	55	KET-TAM	149	VHB	157
DE-D	110/111	KFA V20	152	VHE-A	155
DLB	56	KFB-TM	147	VHP	142/143
DLT-N	58/59	KFD V20	151	VFB	156
DS/DS-M	114	KFD V40	153	VFS	158
E		KFE-TM	148	W	
ECB-N/ECE-N	62	KFN-TM	148	WTB-N/WTB-NM	78
EG-N/EW-N	36/37	KFP V20 IP65	150		
EMB	16	KFP V20 IP67	151		
EMB-S	15	KFP V30	153		
EMB-V	17	KFP V40	153		
EMS	18	KFS-TM	147		
EOA/EOE	107	KFU V20	152		
EOB/EOS	108	KFU V30	152		
EOB-F/EOS-F	109	KXG-TM	147		
EWJ	28/29	KXP V20 IP65	150		
F		KXS-TM	148		
FCB	65	M			
FCE-N	64	MLS-D	57		
FFN-N	79	N			
FKA	96	NBB	138		
FKB-A	66	NFB	137		
FKB/FKB-M	69	NFN	139		
FKC	97				



Product group index 2016

01	Pocket balances			9 – 10
02	Precision balances	NEWS		11 – 43
03	Analytical balances	NEWS		44 – 52
04	Moisture analysers	NEWS		53 – 59
05	Bench scales	NEWS		60 – 71
06	Stainless steel/Protection against dust and water splashes IP65...68			72 – 82
07	Price computing scales			83 – 85
08	Counting scales/Counting systems/ Special stocktaking scales	NEWS		86 – 103
09	Parcel scales/Platform scales	NEWS		104 – 122
10	Floor scales/Pallet scales/Drive-through scales	NEWS		123 – 140
11	Axle load scales			141 – 143
12	Display devices/Platforms/Weighing bridges			144 – 153
13	Pallet truck scales			154 – 158
14	Hanging scales/Crane scales	NEWS		159 – 168
15	Special equipment: Scales to meet Pre-packaging legislation/ ATEX scales/Bottle stocktaking scales			169 – 175
16	Accessories	NEWS		176 – 187
17	Test weights			188 – 207
18	DAkKS Calibration Service (DKD)			208 – 213

Do you have questions about our products?
Our customer consultants will be pleased to assist you:

UK, IE, MT, Scandinavia



Marietta Diener

Tel. +49 [0] 7433 9933-167
Fax +49 [0] 7433 9933-29167
Mobil +49 [0] 151 46143236
diener@kern-sohn.com

USA, CAN, TR, Middle East, Africa, Oceania, South East Asia



Corinna Klaass

Tel. +49 [0] 7433 9933-215
Fax +49 [0] 7433 9933-29215
klaass@kern-sohn.com

PT, SLO, HR, BA, RS, MK, BeNeLux



Taras Mikitisin

Tel. +49 [0] 7433 9933-143
Fax +49 [0] 7433 9933-29143
Mobil +49 [0] 171 5590115
mikitisin@kern-sohn.com

CZ, SK, DE (Zip Code 4, 5, 6)



Katharina Queitsch

Tel. +49 [0] 7433 9933-218
Fax +49 [0] 7433 9933-29218
Mobil +49 [0] 151 46142894
katharina.queitsch@kern-sohn.com

BG, HU, PL, RO



Fabienne Kolbus

Tel. +49 [0] 7433 9933-305
Fax +49 [0] 7433 9933-29305
fabienne.kolbus@kern-sohn.com

GUS, EE, LT, LV



Inna Wandler

Tel. +49 [0] 7433 9933-218
Fax +49 [0] 7433 9933-29218
Mobil +49 [0] 151 46142894
wandler@kern-sohn.com

Product specialist Touchscreen balances/Special equipment



Ingo Schlaich

Tel. +49 [0] 7433 9933-158
Fax +49 [0] 7433 9933-29158
ingo.schlaich@kern-sohn.com

General Management



Albert Sauter

Tel. +49 [0] 7433 9933-157
Fax +49 [0] 7433 9933-29157
albert-sauter@kern-sohn.com

Sales Management



Ulrich Ulmer

Tel. +49 [0] 7433 9933-160
Fax +49 [0] 7433 9933-29160
Mobil +49 [0] 172 7423944
ulmer@kern-sohn.com

Marketing Management



Thomas Fimpel

Tel. +49 [0] 7433 9933-130
Fax +49 [0] 7433 9933-29130
fimpel@kern-sohn.com

Technical Service



Markus Reinke

Tel. +49 [0] 7433 9933-199
Fax +49 [0] 7433 9933-195
reinke@kern-sohn.com



Heiko Taufenbach

Tel. +49 [0] 7433 9933-199
Fax +49 [0] 7433 9933-195
taufenbach@kern-sohn.com



Edgar Litt

Tel. +49 [0] 7433 9933-199
Fax +49 [0] 7433 9933-195
litti@kern-sohn.com

DAkKs Calibration Service (DKD)



GB, IE, BeNeLux, FR, North,
Central & South America, Maghreb,
Africa, DE (Zip Code 8, 9)

Tolga Gümüs

Tel. +49 [0] 7433 9933-210
Fax +49 [0] 7433 9933-29210
tolga.guemues@kern-sohn.com



DE (PLZ 5, 6, 7), ES, PT, IT, AUS,
Skandinavien, Ozeanien

Sandra Ehinger

Tel. +49 [0] 7433 9933-162
Fax +49 [0] 7433 9933-29162
sandra.ehinger@kern-sohn.com



GR, TR, Eastern Europe, Baltic
States, CIS, South East Asia, AT, CH,
DE (Zip Code 0, 1, 2, 3, 4)

Waldemar Fleitling

Tel. +49 [0] 7433 9933-163
Fax +49 [0] 7433 9933-29163
fleitling@kern-sohn.com

Accountancy



Jutta Osswald

Tel. +49 [0] 7433 9933-159
Fax +49 [0] 7433 9933-29159
jutta.osswald@kern-sohn.com

We also have lots of new models in our range for 2016.
Innovative products in the usual KERN quality:

School balance KERN EMB-S

The space miracle - stackable school balance for experiment-based teaching
Further details → page 15



from € 200,- (pack of 5)

Precision balances PNS · PNJ

The new standard in the laboratory with robust tuning fork weighing system
Further details → page 32



from € 570,-

Analytical balance KERN ADB

The price leader in analytical balances
Further details → page 45



only € 910,-

Moisture analyser DAB

Moisture analyser with user-friendly graphics display and 15 memories for drying programs
Further details → page 54



only € 1130,-

Moisture analyser MLS-D

Infrared moisture analyzer with graphics display and a vast database
Further details → page 57



only € 1450,-

Premium counting system CCP

Premium counting system for high-capacity counting applications with the highest level of accuracy, counting resolution up to 6 million points
Further details → page 100



from € 2600,-

Premium counting system CCT

Premium counting system with EC type approval [M], for complex counting applications with the highest level of accuracy, counting resolution up to 6 million points
Further details → page 102



from € 2700,-

Pallet scale UFC

Pallet scale with steel load support (IP67) and stainless steel display device (IP65), with EC type approval [M]
Further details → page 135



only € 1280,-

Crane scales HFO

Industrial crane scale up to 6 t - with EC type approval [M]
Further details → page 166



from € 1020,-

Thermal label printer YKE-01

Cost-effective universal label printer for KERN balances
Further details → page 178



only € 590,-

Touchscreen models KERN AET · PET · ILT · KEN · KET – State-of-the-art premium touchscreen balance series with the complete range of functions for demanding processes

Come and enjoy the many benefits of the innovative touchscreen models

- Large touch display for easy operation and convenient reading
- The menu and processes are self-explanatory
- Intuitive, graphically supported operation, by using Smartphones, tablets, etc.
- No more errors or lost time through keys which have several functions or unclear markings
- Ensures a more efficient and rapid operation
- Large keys, which can also be operated while wearing gloves
- Wide range of functions, software which can be customised to suit your individual requirements, vast database



Ingo Schlaich

Product specialist Touchscreen balances

Tel. +49 [0] 7433 9933-158
Fax +49 [0] 7433 9933-29158
ingo.schlaich@kern-sohn.com

KERN – Weighing can be this simple.



**Analytical balance
KERN AET**
For all details see
page 50/51



**Precision balance
KERN PET**
For all details see
page 41-43



**Platform scale
KERN ILT**
For all details see
page 120/121



**Display device
KERN KEN-TM**
For all details see
page 149



**Display device
KERN KET-TAM**
For all details see
page 149

Features of the new touchscreen models KERN AET · PET · ILT · KEN · KET



Innovative touchscreen

Large backlit and touch-sensitive LCD screen with digit height 17 mm, screen size 5.7" (approx. 145 mm), WxH 115x86 mm. Dimensions of display device WxDxH 208x71x150 mm.



Electronic level indicator

permanently checking the position of the balance, sounding an alarm when the device is out of balance and giving visual instructions on how to correct this (not ILT-GM)

3 rapid assignment keys

for frequently recurring applications, functions, settings or memory contents



2 infrared sensors

to initiate functions such as TARE, zeroing, for carrying out, starting or aborting adjustment, calling up database or menu and much more, without having to touch the balance – just give it a wave!

Individual print formats

up to 16 printouts to be edited easily at the PC

High level of connectivity

- 1 x Ethernet
- 2 x RS-232
- 2 x USB
- e.g. for data exchange or connecting barcode or RFID scanners
- Digital I/O (4 in/4 out) e.g. to control machines and plants
- 1 x additional display
- 1 x WLAN (selected models)



Individual user settings can be stored

- User name and number
- Password
- Authorisations
- Menu language (DE, GB, FR, IT, ES, PL)
- User profiles
- Additional guest mode for users without user log-in

Alibi memory

Electronic archiving of weighing results, see also page 214

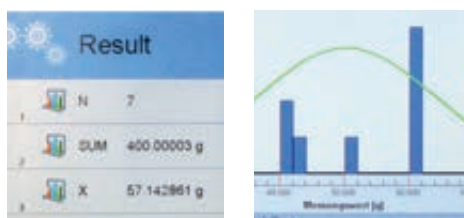

Statistical function

for statistical analysis of series of measurements. The graphic display (only AET, PET) of measurements can be used by the operator to check and evaluate their results

Intuitive use, increases efficiency and saves costs

Easy capture of article data at the PC, call up of items on the balance using the connected barcode or RFID scanner, output of weighing data using the large or second display or control outputs, data transfer to the PC, printer or alibi memory.

High level of process reliability

you can define limit values for selected parameters, such as, for example, temperature, humidity (only models where [d] = 0,01 mg), levelling, minimum load, adjustment etc. When the value falls outside these limits, a warning message will be issued. Limit values and warning messages can be archived with the weighing result

Convenient recipe-weighing

complete recipes with all recipe ingredients and associated nominal values, names, tolerances, tare weights etc. can be stored. If one recipe ingredient is overweight, then the practical recipe adjustment function for when dosages are exceeded automatically calculates the new target weights of the other ingredients. Recipes and their ingredients can be multiplied at will at the press of a button, which is ideal for the production of larger containers, bulk packs etc. (Multiplier function)

Enormous database (up to 8 GB)

can be filled easily at the PC using the optional software KERN PET-A01 (suitable for KERN AET, PET) or KET-A04 (suitable for ILT-GAM, ILT-BAM, KET-TAM), for more details see page 184. Particularly beneficial when counting a large number of individual items, as part of a stock-tacking, for checkweighing, recording recipes etc.



Data exchange via USB

to download software updates, export recipes or weighing results, export/import databases, balance settings, data exchange between individual balances and much more

WE WILL SOLVE YOUR PROBLEMS - SPECIAL BALANCES BY KERN

ATEX scales

Weighing – without it going bang!

In areas where there is a high potential risk of explosion, the user must be able to rely on his apparatus 100 %. We have designed our ATEX IEX and OEX balance ranges for this application.

For all important information on this subject, please see page 174



Axle load scales

Over the legal limit ...?

...not with the mobile axle load scales from the KERN VHP range!

In particular on building sites, at harvest time, when weighing small aircraft or as part of mobile police checks, you can quickly establish whether a vehicle is overloaded or incorrectly loaded, at a reasonable price.

For all important information, please see page 142



Stocktaking scales

Get your inventory levels in an instant

Save valuable time and money when recording your stock levels. Whether as a checkweigher in Goods Inwards, when picking small parts in sales or when recording your entire stock levels within the scope of a regular inventory – with the KERN inventory and Goods Inwards system you are always in safe hands.

For all important information on this subject, please see pages 95 - 97 and page 175



Compact crane scales/force-measuring devices

Harsh environments mean that you need tough tools

These electronic tensile dynamometers are extremely versatile thanks to their stable, compact construction, they can, for example, be fitting into testing machines, used for checking for overload, for bracing and tensile force measurement, etc. This is where the benefit of this construction comes to the fore, as the tensile force can be applied in both directions.

For all important information, please see pages 163/164



Pocket size precision

Pocket balances are the ideal helpers whenever mobility and high precision are required. Since they have fewer keys, operation is simple and fast. Different weighing units stored in the pocket balance, such as g, oz, ct, gn, etc., make them universally usable. An integrated calculator lets you use the measured weight immediately in calculations, to e.g. determine a price, quantity, average value and much more. Compact in size and well protected with a flap or protective cover, which can be used as a convenient taring container, the pocket balance is always a useful tool for mobile weighing.

- In production, to control of production weights or during the picking of small parts
- In quality control for the quick testing of small parts like plastic parts from injection moulding machines, milled parts, screws, etc.
- For mobile weighing, on-site sampling, and fast analysis wherever there's no power outlet
- In hobbies and sports, e.g. when filling black powder, weighing parts from modelling kits etc.

- In commerce, for the fast determination of the weights of coins, jewellery, precious stones, etc.
- In veterinary sector for the weighing of small animals, the mixing of feed, etc.
- In the food sector for the preparation of spice or tea mixes, for the weighing of food in line with a diet sheet.

Quick-Finder Pocket balances

Read-out [d]	Weighing range [Max]	Model KERN	Price excl. of VAT ex works €	Page	DAYS ready for shipping		
0,001 g	20 g	TAB 20-3	70,-	10	1		
0,002 g	10 g	CM 50-C2N	90,-	10	1		
0,01 g	60 g	CM 60-2N	79,-	10	1		
0,1 g	150 g	TEE 150-1	38,-	10	1		
0,1 g	150 g	CM 150-1N	52,-	10	1		
0,1 g	200 g	TCB 200-1	52,-	10	1		
0,1 g	320 g	CM 320-1N	55,-	10	1		
1 g	1000 g	CM 1K1N	52,-	10	1		

= Carat balances

= Standard

= Option

Your product specialist's recommendation:



Simple and convenient 2-key operation



Backlit LCD display



Cover can also be used as a tare cup



Also ideal as a gift for your customers



Katharina Queitsch

Product specialist Pocket balances

Tel. +49 [0] 7433 9933-218

Fax +49 [0] 7433 9933-29218

katharina.queitsch@kern-sohn.com



KERN TEE

▶ page 10



KERN TEE

Designer pocket balance at a bargain price



KERN TCB

This is where the fun starts with pocket format weighing



1 KERN CM

Small, practical and protected in a hard case cover



KERN TAB

High-precision pocket carat balance for jewellers and travelling salesmen

STANDARD

CAL EXT UNIT BATT 1 DAY

STANDARD OPTION

2 YEARS WARRANTY DAKkS +3 DAYS

STANDARD

CAL EXT UNIT BATT 1 DAY

STANDARD OPTION

2 YEARS WARRANTY DAKkS +3 DAYS

STANDARD

CAL EXT UNIT BATT 1 DAY

STANDARD OPTION

2 YEARS WARRANTY DAKkS +3 DAYS

STANDARD

CAL EXT UNIT BATT 1 DAY

STANDARD OPTION

2 YEARS WARRANTY DAKkS +3 DAYS

- Simple and convenient 2-key operation
- Cover made of shock proof plastic as protection against pressure and dust. Can also be used as a tare cup
- Note: Can be printed with your logo, from 100 pcs. Please ask for details

- Simple and convenient 2-key operation
- Small and handy
- Transport box and weighing pan included
- Revolving weighing plate (as overload protection)
- Note: Individual logo printing on request

- Hard case cover as protection against pressure and dust

- 1 CM:**
- Integrated calculator

- 2 CM-C:**
- Hard case cover as protection against pressure and dust
 - Adjusting weight standard
 - Draft shield against air movements standard
 - Weighing pan standard

- Simple and convenient 4-key operation
- Can be switched over from g to ct, gn at the touch of a key
- Hard case cover as protection against pressure and dust
- Adjusting weight and weighing pan standard



2

KERN	TEE 150-1	TCB 200-1	CM 60-2N	CM 150-1N	CM 320-1N	CM 1K1N	CM 50-C2N	TAB 20-3
Weighing range [Max] g	150 g	200 g	60 g	150 g	320 g	1000 g	10 g 50 ct	20 g 100 ct
Readout [d] g	0,1 g	0,1 g	0,01 g	0,1 g	0,1 g	1 g	0,002 g 0,01 ct	0,001 g 0,005 ct
LCD display	backlit, digit height 9 mm	Digit height 9 mm	Digit height 12 mm			Digit height 9 mm	backlit, digit height 9 mm	
Dimensions of weighing plate	WxD 60x64 mm	Ø 80 mm	WxD 70x80 mm			WxD 50x40 mm	WxD 36x42 mm	
Overall dimensions	WxDxH 67x100x22 mm	ØxH 80 mm	WxDxH 85x130x25 mm			WxDxH 95x133x33 mm		
Power supply	Batteries included, 2 x 1,5 V AAA	Batteries included, 2 x LR 44 AUTO-OFF function to preserve battery life, can be switched off	Batteries included, 2 x 1,5 V AAA AUTO-OFF function to preserve battery life, can be switched off			Batteries included, 4 x 1,5 V AAA operating time approx. 150 h		
Net weight	100 g	50 g	ca. 30 h	ca. 70 h	ca. 30 h	200 g		
Permissible ambient temperature	5 °C / 35 °C						10 °C / 30 °C	
Price €, excl. of VAT, ex works	38,-	52,-	79,-	52,-	55,-	52,-	90,-	70,-
Option DAKkS Calibr. Certificate	963-127, 72,-							

Precision balances

Single-cell cutting edge technology Precision balances





To meet stricter requirements for precision, speed, and → **reproducibility** of weight values, monolithic load cells are ever more often becoming the standard. These are measuring sensors for the determination of weight that are made of a compact piece of aluminium. These systems distinguish themselves from conventional load cells in terms of both quality and performance:

- Higher measuring speed
- Better measuring precision
- Stable temperature behaviour
- Improved mechanical sturdiness
- Higher corner load reliability

KERN precision and analytical balances equipped with this measuring system are designated as using "Single Cell Technology" (→ **SC TECH**).

→ See the glossary on page 214 – 216

Your product specialist's recommendation:

-  **School balance for experiment-based teaching**
-  **Saves space because it can be stacked**
-  **X-tra low profile design**



Corinna Klaass
Product specialist Precision balances

Tel. +49 [0] 7433 9933-215
Fax +49 [0] 7433 9933-29215
klaass@kern-sohn.com













from €
200,-
(set of 5 units)

► page 15

KERN EMB-S

Quick-Finder Precision balances











Read-out [d]	Weighing range [Max]	Model KERN	Price excl. of VAT ex works €	Page	DAYS ready for shipping	         									
						For an explanation on the pictos, see the front flap									
0,001 g	60 g	440-21A	350,-	22	1			●		●		●		○	○
0,001 g	100 g	EMB 100-3	195,-	16	1			●						●	
0,001 g	100 g	PCB 100-3	265,-	20	1			●		●				○	○
0,001 g	120 g	KB 120-3N	270,-	25	1			●		●				○	○
0,001 g	120 g	PFB 120-3	280,-	23	1			●		●					
0,001 g	200 g	EMB 200-3	210,-	16	1			●						●	
0,001 g	200 g	EMB 200-3V	250,-	17	1			●		●				●	
0,001 g	200 g	PFB 200-3	290,-	23	1			●		●					
0,001 g	200 g	PKS 200-3	420,-	26	1			●	●	●			●		○
0,001 g	220 g	EW 220-3NM	620,-	36	1			●		●			●		○
0,001 g	220 g	EG 220-3NM	760,-	36	1	○	●			●			●		○
0,001 g	240 g	KB 240-3N	280,-	25	1			●		●					○
0,001 g	240 g	572-30	520,-	30	1			●		●					○
0,001 g	250 g	PCB 250-3	290,-	20	1			●		●				○	○
0,001 g	250 g	PCD 250-3	305,-	19	1			●		●				○	○
0,001 g	300 g	EMS 300-3	260,-	18	1			●						○	
0,001 g	300 g	PFB 300-3	320,-	23	1			●		●					
0,001 g	300 g	EWJ 300-3	465,-	28	1		●			●					○
0,001 g	300 g	572-31	520,-	30	1			●		●					○
0,001 g	300 g	PKT 300-3	740,-	34	1			●	●	●			●		○
0,001 g	350 g	PCB 350-3	300,-	20	1			●		●				○	○
0,001 g	360 g	KB 360-3N	300,-	25	1			●		●					○
0,001 g	360 g	PKS 360-3	430,-	26	1			●	●	●			●		○
0,001 g	360 g	PLJ 300-3CM	710,-	33	1	○	●		●	●			●		
0,001 g	420 g	PLE 420-3N	450,-	24	1			●		●			●		○
0,001 g	420 g	572-32	540,-	30	1			●		●					○
0,001 g	420 g	PLS 420-3F	590,-	31	1			●		●			●		
0,001 g	420 g	EW 420-3NM	690,-	36	1			●		●			●		○
0,001 g	420 g	PLJ 420-3F	700,-	31	1		●			●			●		
0,001 g	420 g	PKT 420-3	770,-	34	1			●	●	●			●		○
0,001 g	420 g	EG 420-3NM	830,-	36	1	○	●		●	●			●		○
0,001 g	600 g	PLJ 600-3CM	750,-	33	1	○	●		●	●			●		
0,001 g	600 g	PET 600-3M	2500,-	41	21	○	●		●	●	●		●		
0,001 g	620 g	PNS 600-3	590,-	32	1			●		●			●		
0,001 g	620 g	PNJ 600-3M	720,-	32	1	○	●			●			●		
0,001 g	620 g	EW 620-3NM	770,-	36	1			●		●			●		○
0,001 g	620 g	EG 620-3NM	930,-	36	1	○	●		●	●			●		○
0,001 g	620 g	PES 620-3M	1280,-	40	1			●		●			●		○
0,001 g	620 g	PBS 620-3M	1360,-	38	1			●		●			●		
0,001 g	620 g	PBJ 620-3M	1590,-	38	1	○	●			●			●		
0,001 g	620 g	PEJ 620-3M	1480,-	40	1	○	●			●			●		
0,001 g	720 g	PLS 720-3A	850,-	31	1			●		●			●		
0,001 g	720 g	PLJ 720-3A	990,-	31	1		●			●			●		
0,001 g	720 g	PLJ 720-3AM	1050,-	31	1	○	●			●			●		
0,001 g	750 g	PLJ 700-3CM	730,-	33	1	○	●		●	●			●		
0,001 g	1000 g	PET 1000-3M	2800,-	41	21	○	●		●	●	●		●		
0,001 g	1200 g	PLS 1200-3A	870,-	31	1			●		●			●		
0,001 g	1200 g	PLJ 1200-3A	1005,-	31	1		●			●			●		
0,001 g	2100 g	PLJ 2000-3A	1700,-	31	1		●			●			●		
0,01 g	200 g	EMB 200-2	125,-	16	1			●						●	
0,01 g	200 g	PCB 200-2	230,-	20	1			●		●				○	○
0,01 g	200 g	440-33N	290,-	22	1			●		●				○	○
0,01 g	400 g	440-35N	330,-	22	1			●		●				○	○
0,01 g	600 g	EMB 600-2	160,-	16	1			●						●	
0,01 g	600 g	PFB 600-2M	270,-	23	1	○		●		●				●	
0,01 g	600 g	440-35A	365,-	22	1			●		●				○	○
0,01 g	600 g	EWJ 600-2M	410,-	28	1	○	●		●	●			●		○
0,01 g	600 g	PLJ 600-2GM	540,-	33	1	○	●			●			●		○
0,01 g	650 g	KB 650-2NM	320,-	25	1	○		●		●			●		○
0,01 g	650 g	573-34NM	550,-	30	1	○		●		●			●		
0,01 g	650 g	KBJ 650-2NM	690,-	25	1	○	●			●			●		○
0,01 g	820 g	EW 820-2NM	540,-	36	1			●		●			●		○
0,01 g	1000 g	EMB 1000-2	195,-	16	1			●						●	
0,01 g	1000 g	PCB 1000-2	255,-	20	1			●		●				○	○
0,01 g	1200 g	PFB 1200-2	245,-	23	1			●		●					
0,01 g	1200 g	KB 1200-2N	270,-	25	1			●		●					○
0,01 g	1600 g	572-33	480,-	30	1			●		●					○
0,01 g	2000 g	EMB 2000-2	205,-	16	1			●						●	
0,01 g	2000 g	EMB 2000-2V	250,-	17	1			●		●				●	
0,01 g	2000 g	PFB 2000-2	255,-	23	1			●		●					
0,01 g	2000 g	KB 2000-2N	270,-	25	1			●		●					○

■ = News 2016

● = Standard

○ = Option

Quick-Finder Precision balances

Read-out [d]	Weighing range [Max]	Model KERN	Price excl. of VAT ex works €	Page	 DAYS ready for shipping	         									
						For an explanation on the pictos, see the front flap									
0,01 g	2000 g	PKS 2000-2	430,-	26	1			●	●	●		●	●		○
0,01 g	2200 g	EW 2200-2NM	660,-	36	1			●		●		●	●		○
0,01 g	2200 g	EG 2200-2NM	820,-	36	1	○	●			●		●	●		○
0,01 g	2200 g	PES 2200-2M	830,-	40	1			●		●		●	●		○
0,01 g	2200 g	PEJ 2200-2M	1040,-	40	1	○	●			●		●	●		○
0,01 g	2400 g	KB 2400-2N	280,-	25	1			●		●		●	●		○
0,01 g	2400 g	572-35	490,-	30	1			●		●		●	●		○
0,01 g	2500 g	PCB 2500-2	290,-	20	1			●		●		●	●		○
0,01 g	2500 g	PCD 2500-2	295,-	19	1			●		●		●	●		○
0,01 g	2500 g	PET 2500-2M	2400,-	41	21	○	●		●	●	●	●	●		○
0,01 g	3000 g	EMS 3000-2	240,-	18	1			●		●		●	●		○
0,01 g	3000 g	PFB 3000-2	280,-	23	1			●		●		●	●		○
0,01 g	3000 g	EWJ 3000-2	445,-	28	1			●		●		●	●		○
0,01 g	3000 g	572-37	490,-	30	1			●		●		●	●		○
0,01 g	3100 g	PLJ 3000-2FM	660,-	31	1			●		●		●	●		○
0,01 g	3000 g	PKT 3000-2	740,-	34	1			●	●	●		●	●		○
0,01 g	3200 g	PNS 3000-2	580,-	32	1			●		●		●	●		○
0,01 g	3200 g	PNJ 3000-2M	680,-	32	1	○	●			●		●	●		○
0,01 g	3500 g	PCB 3500-2	300,-	20	1			●		●		●	●		○
0,01 g	3500 g	PLJ 3000-2CM	710,-	33	1	○	●		●	●	●	●	●		○
0,01 g	3600 g	KB 3600-2N	290,-	25	1			●		●		●	●		○
0,01 g	3600 g	PKS 3600-2	440,-	26	1			●	●	●		●	●		○
0,01 g	4200 g	PLE 4200-2N	450,-	24	1			●		●		●	●		○
0,01 g	4200 g	572-39	520,-	30	1			●		●		●	●		○
0,01 g	4200 g	PLS 4200-2F	590,-	31	1			●		●		●	●		○
0,01 g	4200 g	PLJ 4200-2F	690,-	31	1			●	●	●		●	●		○
0,01 g	4200 g	EW 4200-2NM	740,-	36	1			●		●		●	●		○
0,01 g	4200 g	PKT 4200-2	770,-	34	1			●	●	●		●	●		○
0,01 g	4200 g	EG 4200-2NM	880,-	36	1	○	●			●		●	●		○
0,01 g	4200 g	PES 4200-2M	980,-	40	1			●		●		●	●		○
0,01 g	4200 g	PBS 4200-2M	1150,-	38	1			●		●		●	●		○
0,01 g	4200 g	PEJ 4200-2M	1190,-	40	1	○	●			●		●	●		○
0,01 g	4200 g	PBJ 4200-2M	1420,-	38	1	○	●			●		●	●		○
0,01 g	6000 g	PET 6000-2M	2600,-	41	21	○	●		●	●	●	●	●		○
0,01 g	6200 g	EW 6200-2NM	810,-	36	1			●		●		●	●		○
0,01 g	6200 g	PLS 6200-2A	870,-	31	1			●		●		●	●		○
0,01 g	6200 g	PLJ 6200-2A	990,-	31	1			●	●	●		●	●		○
0,01 g	6200 g	PLJ 6200-2AM	1050,-	31	1	○	●			●		●	●		○
0,01 g	6200 g	PES 6200-2M	1210,-	40	1			●		●		●	●		○
0,01 g	6200 g	PBS 6200-2M	1380,-	38	1			●		●		●	●		○
0,01 g	6200 g	PBJ 6200-2M	1720,-	38	1	○	●			●		●	●		○
0,01 g	8200 g	PLS 8000-2A	1050,-	31	1			●		●		●	●		○
0,05 g	6 kg	PFB 6K0.05	250,-	23	1			●		●		●	●		○
0,05 g	10 kg	KB 10K0.05N	280,-	25	1			●		●		●	●		○
0,05 g	12 kg	572-45	490,-	30	1			●		●		●	●		○
0,05 g	12 kg	PKT 12K0.05	630,-	34	1			●	●	●		●	●		○
0,05 g	20 kg	572-55	520,-	30	1			●		●		●	●		○
0,1 g	200 g	EMB 200-1SS05*	200,-	15	1			●		●		●	●		○
0,1 g	400 g	440-43N	185,-	22	1			●		●		●	●		○
0,1 g	500 g	EMB 500-1SS05*	225,-	15	1			●		●		●	●		○
0,1 g	500 g	EMB 500-1	57,-	16	1			●		●		●	●		○
0,1 g	500 g	EMB 500-1GN	57,-	16	1			●		●		●	●		○
0,1 g	600 g	PFB 600-1M	340,-	23	1	○		●		●		●	●		○
0,1 g	1000 g	PCB 1000-1	185,-	20	1			●		●		●	●		○
0,1 g	1000 g	440-45N	245,-	22	1			●		●		●	●		○
0,1 g	1200 g	EMB 1200-1	80,-	16	1			●		●		●	●		○
0,1 g	2000 g	PCB 2000-1	215,-	20	1			●		●		●	●		○
0,1 g	2000 g	440-47N	270,-	22	1			●		●		●	●		○
0,1 g	3000 g	EMB 3000-1	125,-	16	1			●		●		●	●		○
0,1 g	4000 g	440-49N	330,-	22	1			●		●		●	●		○
0,1 g	6000 g	EMB 6000-1	160,-	16	1			●		●		●	●		○
0,1 g	6000 g	EMS 6K0.1	160,-	18	1			●		●		●	●		○
0,1 g	6000 g	PFB 6000-1	220,-	23	1			●		●		●	●		○
0,1 g	6000 g	PCB 6000-1	245,-	20	1			●		●		●	●		○
0,1 g	6000 g	PFB 6000-1M	260,-	23	1	○		●		●		●	●		○
0,1 g	6000 g	440-49A	365,-	22	1			●		●		●	●		○
0,1 g	6000 g	EWJ 6000-1M	400,-	28	1	○	●			●		●	●		○
0,1 g	6000 g	PLJ 6000-1GM	540,-	33	1	○	●			●		●	●		○
0,1 g	6500 g	KB 6500-1NM	320,-	25	1	○		●		●		●	●		○
0,1 g	6500 g	573-46NM	550,-	30	1	○		●		●		●	●		○
0,1 g	8200 g	PBS 8200-1M	490,-	38	1	○		●		●		●	●		○











■ = News 2016

* set of 5 units

● = Standard

○ = Option

Quick-Finder Precision balances

Read-out	Weighing range	Model	Price excl. of VAT ex works €	Page	 DAYS ready for shipping										
[d]	[Max]	KERN				For an explanation on the pictos, see the front flap									
0,1 g	8200 g	PBJ 8200-1M	1410,-	38	1	○	●			●		●			
0,1 g	10 kg	PCD 10K0.1	220,-	19	1			●		●		●		○	○
0,1 g	10 kg	PCB 10000-1	240,-	20	1			●		●		●		○	○
0,1 g	10 kg	KB 10000-1N	260,-	25	1			●		●		●			○
0,1 g	10 kg	PKS 10K0.1	400,-	26	1			●	●	●		●	●		○
0,1 g	10 kg	572-43	480,-	30	1			●		●		●			○
0,1 g	12 kg	EMS 12K0.1	205,-	18	1			●				●		○	
0,1 g	12 kg	PNS 12000-1	570,-	32	1			●		●		●	●		
0,1 g	12 kg	PNJ 12000-1M	680,-	32	1	○	●			●		●			
0,1 g	12 kg	EW 12000-1NM	635,-	36	1			●		●		●	●		○
0,1 g	15 kg	PES 15000-1M	1190,-	40	1			●		●		●	●		○
0,1 g	16 kg	572-49	480,-	30	1			●		●		●			○
0,1 g	16 kg	PKT 16K0.1	630,-	34	1			●	●	●		●	●		○
0,1 g	20 kg	PLS 20000-1F	590,-	31	1			●		●		●	●		○
0,1 g	24 kg	572-57	490,-	30	1			●		●		●			○
0,1 g	24 kg	PKT 24K0.1	650,-	34	1			●	●	●		●	●		○
0,1 g	31 kg	PES 31000-1M	1960,-	40	1			●		●		●	●		○
1 g	2000 g	EMB 2000-0SS05*	200,-	15	1			●						●	
1 g	2200 g	EMB 2200-0	60,-	16	1			●						●	
1 g	4000 g	440-51N	160,-	22	1			●		●		●		○	○
1 g	5000 g	EMB 5000-0SS05*	225,-	15	1			●						●	
1 g	5200 g	EMB 5.2K1	60,-	16	1			●						●	
1 g	6000 g	EMS 6K1	70,-	18	1			●				●		○	
1 g	6000 g	PCB 6000-0	130,-	20	1			●		●		●		○	○
1 g	6000 g	440-53N	180,-	22	1			●		●		●		○	○
1 g	6000 g	PFB 6000-0M	330,-	23	1	○		●		●		●			
1 g	12 kg	EMS 12K1	95,-	18	1			●				●		○	
5 g	5200 g	EMB 5.2K5	55,-	16	1			●						●	

■ = News 2016

* set of 5 units

● = Standard

○ = Option

School balance KERN EMB-S



02



The space miracle – stackable school balance for experiment-based teaching

Features

- **Simple and convenient 2-key operation**, making them ideal for use in schools and universities
- **Tare function** facilitates formulation work
- **Particularly flat design**
- **Secure and non-slip positioning** with rubber feet
- **1 Stackable** for space-saving storage
- **2 A practical transport safety lock** prevents the weighing technology from being overloaded when stored or during transportation
- **Hook for underfloor weighing** standard

Technical data

- Large LCD display, digit height 15 mm
- Dimensions weighing surface Ø 120 mm
- Weighing plate material plastic
- Net weight approx. 0,5 kg/piece
- Optional battery operation, 2 x 1,5 V AA, standard, operating time up to 35 h, AUTO-OFF function to preserve the battery
- Permissible ambient temperature 5 °C / 35 °C
- **Note:** The models are only delivered in a set of 5 units. i.e. the price given in the table refers to a delivery of 5 items. Cannot be delivered individually. The calibration prices given here refer to calibration of a single balance

Accessories

- **External universal mains adapter**, with universal input and optional input socket adapters for EU, GB, USA, not included, can be retrofitted, KERN YKA-03, **€ 40,-**

STANDARD



OPTION



Model	Weighing range [Max] g	Readout [d] g	Reproducibility g	Linearity g	Dimensions housing WxDxH mm	Price set of 5 units excl. of VAT ex works €	Option DAkKS Calibr. Certificate	
							DKD KERN	€/1 piece
EMB 200-1SS05	200	0,1	0,2	± 0,3	145x205x45	200,-	963-127	72,-
EMB 500-1SS05	500	0,1	0,2	± 0,3	145x205x45	225,-	963-127	72,-
EMB 2000-OSS05	2000	1	2	± 3	145x205x45	200,-	963-127	72,-
EMB 5000-OSS05	5000	1	2	± 3	145x205x45	225,-	963-127	72,-



Entry level laboratory balance with tremendous weighing performance

Features

- **Simple and convenient 2-key operation**, making them ideal for use in schools and universities
- **Tare function** facilitates formulation work
- **Particularly flat design**
- **Ready for use:** Batteries included
- **Ring-shaped draught shield** standard, only for models with weighing plate size **A**, weighing space ØxH 96x35 mm
- **Hook for underfloor weighing** standard

- **Anniversary Gnome edition EMB 500-1GN**, including gnome booklet

Technical data

- Large LCD display, digit height 15 mm
- Weighing plate dimensions, stainless steel, Ø **A** 82 mm, **B** 105 mm, **C** 150 mm, see enlarged picture
- Weighing plate material **A** Plastic, with conductive lacquer **B**, **C** Plastic

- Net weight approx. 0,75 kg
- Permissible ambient temperature 5 °C / 35 °C

Accessories

- **Ring-shaped draught shield**, plastic, only for models with weighing plate size **A**, KERN EMB-A01, **€ 20,-**
- **Stainless steel weighing plate**, only for models with weighing plate size **B**, KERN EMB-A02, **€ 26,-**
- **Stack frame** for space-saving storage of precision balances from the KERN EMB range, scope of delivery 5 pieces, for models with housing dimensions WxDxH 170x240x39 mm: KERN EMB-A07, **€ 40,-**, 170x240x54 mm: KERN EMB-A09, **€ 40,-**
- **External universal mains adapter**, with universal input and optional input socket adapters for EU, GB, USA, not included, can be retrofitted, KERN YKA-03, **€ 40,-**

STANDARD



OPTION



Model	Weighing range [Max] g	Readout [d] g	Reproducibility g	Linearity g	Dimensions housing WxDxH mm	Weighing plate	Price excl. of VAT ex works €	Option DAkkS Calibr. Certificate	
								DKD KERN	€
EMB 100-3	100	0,001	0,001	± 0,005	170x240x54	A	195,-	963-127	72,-
EMB 200-3	200	0,001	0,001	± 0,005	170x240x54	A	210,-	963-127	72,-
EMB 200-2	200	0,01	0,01	± 0,02	170x240x39	B	125,-	963-127	72,-
EMB 600-2	600	0,01	0,01	± 0,03	170x240x39	B	160,-	963-127	72,-
EMB 1000-2	1000	0,01	0,01	± 0,05	170x240x54	C	195,-	963-127	72,-
EMB 2000-2	2000	0,01	0,01	± 0,05	170x240x54	C	205,-	963-127	72,-
EMB 500-1	500	0,1	0,1	± 0,2	170x240x39	C	57,-	963-127	72,-
EMB 500-1GN	500	0,1	0,1	± 0,2	170x240x39	C	57,-	963-127	72,-
EMB 1200-1	1200	0,1	0,1	± 0,3	170x240x39	C	80,-	963-127	72,-
EMB 3000-1	3000	0,1	0,1	± 0,3	170x240x39	C	125,-	963-127	72,-
EMB 6000-1	6000	0,1	0,1	± 0,3	170x240x39	C	160,-	963-128	88,-
EMB 2200-0	2200	1	1	± 2	170x240x39	C	60,-	963-127	72,-
EMB 5.2K1	5200	1	1	± 3	170x240x39	C	60,-	963-128	88,-
EMB 5.2K5	5200	5	5	± 10	170x240x39	C	55,-	963-128	88,-

Compact laboratory balance KERN EMB-V



02

Compact laboratory balance with integrated density determination function

Features

- **Density determination made easy!** Thanks to the self-explanatory, graphic-assisted control panel, the density of solids and liquids can be determined in seconds, making them ideal for use in schools and universities. For interesting facts about density determination see page 214
- Visualised process avoids operating errors
 - No learning time = reduces costs
 - Ideal for untrained users
- The 4 steps are carried out from left to right:
 - 1 Tare the balance by pressing the [TARE] key
 - 2 Select density determination mode (solids/liquids)
 - 3 Weighing of samples/plummet in air
 - 4 Weighing of samples/plummet in liquid. The density will be shown on the display right away
- **Particularly flat design**
- **Hook for underfloor weighing** standard

- **Ready for use:** battery 9 V block standard. AUTO-OFF function to preserve the batteries, can be switched off
- **Note:** Balance and appropriate set for density determination should be ordered at the same time, see accessories

Technical data

- Large LCD display, digit height 15 mm
- Weighing plate dimensions, stainless steel, plastic, Ø
 - A 82 mm, with conductive lacquer
 - B 150 mm, see enlarged picture. The illustration shows the EMB 200-3V model with optional density set YDB-01
- Overall dimensions WxDxH 170x240x54 mm
- Net weight approx. 0,835 kg
- Permissible ambient temperature 5 °C / 35 °C
- **New:** Now also with carat weighing unit:
 - EMB 200-3V: 1000 ct / 0,005 ct
 - EMB 2000-2V: 10000 ct / 0,05 ct

Accessories

for KERN EMB 200-3V:

- **5 Set for density determination** of liquids and solids with density $\leq/\geq 1$. Scope of delivery: Weighing plate, beaker (HxØ 71x51 mm), sample holder, plummet, KERN YDB-01, € 215,-
- **Calibration certificate for the plummet** (20 g), KERN 962-335V, € 143,-

for KERN EMB 2000-2V:

- **6 Set for density determination** of liquids and solids with density $\leq/\geq 1$. Scope of delivery: Weighing plate, beaker (HxØ 135x51 mm), sample holder, plummet, KERN YDB-02, € 330,-
- **Calibration certificate for the plummet** (200 g), KERN 962-338V, € 141,-

STANDARD



OPTION



Model	Weighing range [Max] g	Readout [d] g	Reproducibility g	Linearity g	Weighing plate	Price excl. of VAT ex works €	Option DAKKS Calibr. Certificate	
							DKD KERN	€
EMB 200-3V	200	0,001	0,002	± 0,005	A	250,-	963-127	72,-
EMB 2000-2V	2000	0,01	0,02	± 0,05	B	250,-	963-127	72,-



Entry level model in the low-cost range with large weighing plate

Features

- Especially suitable for use in schools and universities, for example for biology, chemistry, physics
- **Large, shock proof plastic weighing plate**
- **Particularly flat design**
- **Ergonomically optimised key pad** with large keys and a high-contrast LCD display
- **Secure and non-slip positioning** with rubber feet
- **Adjusting program CAL**, external test weights at an additional price, see page 188 ff.
- **Draught shield** standard, only for models with weighing plate size **A**, weighing space WxDxH 145x145x65 mm

Technical data

- LCD display, digit height 25 mm
- Weighing plate dimensions, stainless steel, **A** Ø 105 mm, **B** WxD 175x190 mm, see enlarged picture
- Weighing plate material **A** Plastic, with conductive lacquer **B** Plastic
- Dimensions housing WxDxH 200x280x63 mm
- Optional battery operation, battery 9 V block not standard, operating time up to 40 h, AUTO-OFF function to preserve the battery
- Mains adapter external, standard
- Net weight approx. 1,22 kg
- Permissible ambient temperature 5 °C / 35 °C

Accessories

- **2 Stainless steel weighing plate**, only for models with weighing plate size **B**, KERN EMS-A01, **€ 30,-**
- **Suitable test weights**, also with calibration certificate see page 188

STANDARD



OPTION



Model	Weighing range [Max] g	Readout [d] g	Reproducibility g	Linearity g	Min. piece weight [Counting] g/piece	Weighing plate	Price excl. of VAT ex works €	Option DAkkS Calibr. Certificate	
								DKD KERN	€
KERN EMS 300-3	300	0,001	0,002	± 0,005	0,002	A	260,-	963-127	72,-
EMS 3000-2	3000	0,01	0,02	± 0,05	0,02	B	240,-	963-127	72,-
EMS 6K0.1	6000	0,1	0,1	± 0,3	0,2	B	160,-	963-128	88,-
EMS 12K0.1	12000	0,1	0,1	± 0,3	0,2	B	205,-	963-128	88,-
EMS 6K1	6000	1	1	± 3	2	B	70,-	963-128	88,-
EMS 12K1	12000	1	1	± 3	2	B	95,-	963-128	88,-

Compact laboratory balance KERN PCD



High-resolution precision balance with removable display for maximum flexibility

Features

- **Laboratory balance with separate platform:** Ideal when working in the glove bag or fume cupboard. Particularly practical for weighing toxic, volatile or contaminated substances
- **PRE-TARE function** for manual subtraction of a known container weight, useful for checking fill-levels
- **Freely programmable weighing unit**, e.g. display direct in special units such as length of thread g/m, paper weight g/m², or similar
- **Level indicator and levelling feet** for precise levelling of the scale, fitted as standard, to give the most accurate weighing results
- **Draught shield** standard for models with weighing plate size **A**, weighing space WxDxH 146x146x70 mm

Technical data

- Backlit LCD display, digit height 21 mm
- Weighing plate dimensions, stainless steel, **A** Ø 105 mm, **B** WxD 160x160 mm, see enlarged picture
- Weighing plate material **A** Plastic, with conductive lacquer **B** Stainless steel
- Optional battery operation, 9 V block, not included, operating time up to 12 h. AUTO-OFF function to preserve the battery
- Overall dimensions WxDxH 165x245x142 mm
- Cable length of display device approx. 1,2 m
- Net weight approx. 1,805 kg
- Permissible ambient temperature 5 °C / 35 °C

Accessories

- **Protective working cover** over the display device, scope of delivery: 5 items, KERN PCD-A05S05, **€ 30,-**
- **Stand** to elevate display device, height of stand approx. 250 mm, KERN PCD-A03, **€ 50,-**
- **Foot switch**, ideal when the application requires two free hands. TARE or PRINT function can be selected. Scope of delivery: foot switch, junction box, connection cable. For the PRINT function you will need the RS-232 interface cable, see page 182, KERN YKF-01, **€ 80,-**
- **Rechargeable battery pack internal**, operating time up to 48 h, charging time approx. 8 h. AUTO-OFF function to preserve the battery, can be switched off, KERN PCD-A04, **€ 50,-**
- **RS-232/Ethernet adapter** for connection to an IP-based Ethernet network, for details see page 180, KERN YKI-01, **€ 390,-**
- **Suitable printers** see page 177 ff.

STANDARD



OPTION



Model	Weighing range [Max] g	Readout [d] g	Reproducibility g	Linearity g	Min. piece weight [Counting] g/piece	Weighing plate	Price excl. of VAT ex works €	Option DAKkS Calibr. Certificate	
								DKD KERN	€
KERN PCD 250-3	250	0,001	0,002	± 0,005	0,002	A	305,-	963-127	72,-
KERN PCD 2500-2	2500	0,01	0,02	± 0,05	0,02	B	295,-	963-127	72,-
KERN PCD 10K0.1	10000	0,1	0,2	± 0,3	0,2	B	220,-	963-128	88,-

02



The standard in the laboratory



GLP/ISO record keeping of weighing data, balance adjustment etc. with date, time and identification no. in combination with an appropriate KERN printer. Ideal for monitoring and documenting your processes in accordance with your quality management system



Plus/minus weighing procedures
For example for checking piece weight, production control, for manufacturing packages of equal weight, etc. The deviation of the test items from a defined target weight will be displayed using the respective “+” and “-” symbols.



With the **recipe function** you can weigh the different ingredients of a mixture. As a check, you can also call up the total weight of all the ingredients

Compact laboratory balance KERN PCB



Features

- **PRE-TARE function** for manual subtraction of a known container weight, useful for checking fill-levels
- **Freely programmable weighing unit**, e.g. display direct in special units such as length of thread g/m, paper weight g/m², or similar
- **Percentage determination**: makes it possible to store a given weight value (100 %) and to determine deviations from this target value
- **Ring-shaped draught shield** standard, only for models with weighing plate size **A**, weighing space ØxH 90x40 mm

Technical data

- Backlit LCD display, digit height 15 mm
- Weighing plate dimensions, stainless steel,
 - A** Ø 81 mm
 - B** Ø 105 mm
 - C** WxD 130x130 mm
 - D** WxD 153x173 mm, see enlarged picture
- Weighing plate material
 - A** Plastic, with conductive lacquer
 - B, C, D** Stainless steel
- Optional battery operation, battery 9 V block not standard. Operating time up to 12 h. AUTO-OFF function to preserve the battery, can be switched off
- Overall dimensions (without draught shield) WxDxH 163x245x79 mm
- Permissible ambient temperature 5 °C / 35 °C

Accessories

- **Protective working cover** over keyboard and housing, standard. Can be re-ordered, scope of delivery: 5 items, **€ 30,-** for models with weighing plate size
 - A** KERN PCB-A02S05
 - B** KERN PCB-A03S05
 - C** KERN PCB-A04S05
 - D** KERN PCB-A05S05
- **Hook for underfloor weighing** of hanging loads, standard, can be reordered, KERN 440-A01, **€ 25,-**
- **Rechargeable battery pack internal**, can be retrofitted, operating time up to 48 h without backlight, charging time approx. 8 h. AUTO-OFF function to preserve the battery, can be switched off, KERN PCB-A01, **€ 70,-**
- **Software Balance Connection**, for details see page 179, KERN SCD-4.0, **€ 150,-**
- **Individual header data**: the free software KERN SHM-01 can be used to set up 4 header lines on the printout for printers YKN-01, 911-013 and YKB-01N
- **RS-232/Ethernet adapter** for connection to an IP-based Ethernet network, for details see page 180, KERN YKI-01, **€ 390,-**
- **Suitable test weights**, also with calibration certificate see page 188
- **Suitable printers** see page 177 ff.

STANDARD



OPTION



Model	Weighing range [Max] g	Readout [d] g	Reproducibility g	Linearity g	Min. piece weight [Counting] g/piece	Net weight approx. kg	Weighing plate	Price excl. of VAT ex works €	Option DAKK S Calibr. Certificate	
									DKD KERN	€
KERN PCB 100-3	100	0,001	0,001	± 0,003	0,002	1,1	A	265,-	963-127	72,-
PCB 250-3	250	0,001	0,001	± 0,005	0,002	1,1	A	290,-	963-127	72,-
PCB 350-3	350	0,001	0,002	± 0,005	0,002	1,1	A	300,-	963-127	72,-
PCB 200-2	200	0,01	0,01	± 0,02	0,02	1,1	B	230,-	963-127	72,-
PCB 1000-2	1000	0,01	0,01	± 0,03	0,02	1,4	C	255,-	963-127	72,-
PCB 2500-2	2500	0,01	0,01	± 0,5	0,02	1,4	C	290,-	963-127	72,-
PCB 3500-2	3500	0,01	0,02	± 0,05	0,02	1,4	C	300,-	963-127	72,-
PCB 1000-1	1000	0,1	0,1	± 0,2	0,2	1,4	C	185,-	963-127	72,-
PCB 2000-1	2000	0,1	0,1	± 0,2	0,2	1,4	C	215,-	963-127	72,-
PCB 6000-1	6000	0,1	0,1	± 0,3	0,2	2	D	240,-	963-128	88,-
PCB 10000-1	10000	0,1	0,1	± 0,3	0,2	2	D	245,-	963-128	88,-
PCB 6000-0	6000	1	1	± 2	2	2	D	130,-	963-128	88,-

Compact laboratory balance KERN 440

02



The classic balance in the laboratory

Features

- **Compact size**, practical for small spaces
- **Percentage determination**: makes it possible to store a given weight value (100 %) and to determine deviations from this target value
- **Ring-shaped draught shield** standard, only for models with weighing plate size **A**, weighing space ØxH 90x40 mm

- Optional battery operation, 9 V block, not included. Operating time up to 12 h. AUTO-OFF function to preserve the battery
- Overall dimensions (without draught shield) WxDxH 165x230x80 mm
- Net weight approx. 1 kg
- Permissible ambient temperature 5 °C / 35 °C

- **Rechargeable battery pack internal**, operating time up to 20 h without backlight, charging time approx. 10 h, KERN FCB-A01, € 50,-
- **Second display**, KERN YKD-A01, € 95,-
- **Individual header data**: the free software KERN SHM-01 can be used to set up 4 header lines on the printout for printers YKN-01, 911-013 and YKB-01N
- **Hook for underfloor weighing** of hanging loads, standard, can be reordered, KERN 440-A01, € 25,-
- **RS-232/Ethernet adapter** for connection to an IP-based Ethernet network, for details see page 180, KERN YKI-01, € 390,-
- **Suitable test weights**, also with calibration certificate see page 188
- **Suitable printers** and further, extensive accessories from page 177 ff.

Technical data

- Backlit LCD display, digit height 15 mm
- Weighing plate dimensions, stainless steel,
 - A** Ø 81 mm
 - B** Ø 110 mm
 - C** WxD 133x133 mm
 - D** WxD 150x170 mm, see enlarged picture
- Weighing plate material
 - A** Plastic, with conductive lacquer
 - B, C, D** Stainless steel

Accessories

- **Protective working cover** over keyboard and housing, standard. Can be re-ordered, scope of delivery: 5 items, € 30,- for models with weighing plate size
 - A** KERN 440-210-002S05
 - B** KERN 440-330-002S05
 - C** KERN 440-450-002S05
 - D** KERN 440-530-002S05

STANDARD



OPTION



Model	Weighing range [Max] g	Readout [d] g	Reproducibility g	Linearity g	Min. piece weight [Counting] g/piece	Weighing plate	Price excl. of VAT ex works €	Option	
								DAkkS Calibr. Certificate	
KERN								DKD KERN	€
440-21A	60	0,001	0,001	± 0,003	0,002	A	350,-	963-127	72,-
440-33N	200	0,01	0,01	± 0,02	0,02	B	290,-	963-127	72,-
440-35N	400	0,01	0,01	± 0,03	0,02	B	330,-	963-127	72,-
440-35A	600	0,01	0,01	± 0,03	0,02	B	365,-	963-127	72,-
440-43N	400	0,1	0,1	± 0,2	0,2	C	185,-	963-127	72,-
440-45N	1000	0,1	0,1	± 0,2	0,2	C	245,-	963-127	72,-
440-47N	2000	0,1	0,1	± 0,2	0,2	C	270,-	963-127	72,-
440-49N	4000	0,1	0,1	± 0,3	0,2	D	330,-	963-127	72,-
440-49A	6000	0,1	0,1	± 0,3	0,2	D	365,-	963-128	88,-
440-51N	4000	1	1	± 2	2	D	160,-	963-127	72,-
440-53N	6000	1	1	± 2	2	D	180,-	963-128	88,-

Compact laboratory balance KERN PFB

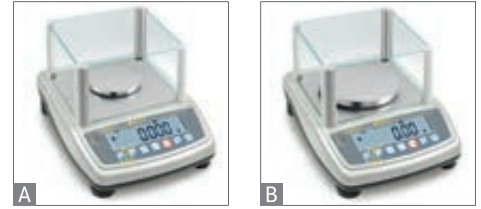

02

Quick-displaying precision balance with user-friendly operation modes and EC type approval

Features

- **Easy to use:** All primary functions have their own key on the keypad
- **Compact size,** practical for small spaces
- **Capacity display:** A bar lights up to show how much of the weighing range is still available
- **Level indicator and levelling feet** for precise levelling of the scale, fitted as standard, to give the most accurate weighing results
- **Draught shield** standard for models with weighing plate size **A** and **B**.
Weighing space WxDxH 158x143x64 mm

- **1 Separate second display** standard for models PFB 600-1M and PFB 6000-0M. Suitable for direct sales to the public. The verification value is the same as the readout. Large backlit LCD display, digit height 16 mm. Interface cable to the balance, cable length approx. 1 m, standard. Dimensions WxDxH 250x180x105 mm

Technical data

- Backlit LCD display, digit height 15 mm
- Weighing plate dimensions, stainless steel,
 - A** Ø 80 mm,
 - B** Ø 120 mm,
 - C** WxD 155x145 mm, see enlarged picture

- Overall dimensions (without draught shield) WxDxH 200x190x87 mm
- Net weight approx. 2 kg
- Permissible ambient temperature 5 °C / 35 °C

Accessories

- **2 Separate second display,** ideal for training and demonstration purposes in laboratories or industry, not permitted for direct sales to the public, KERN PFB-A08, **€ 115,-**
- **Bluetooth data interface** for wireless data transfer to PC, must be ordered at purchase, KERN PFB-A10, **€ 95,-**
- **Suitable printers** see page 177 ff.

STANDARD



OPTION



FACTORY



Model	Weighing range [Max] g	Readout [d] g	Verification value [e] g	Reproducibility g	Linearity g	Weighing plate	Price excl. of VAT ex works €	Options			
								Verification		DAkkS Calibr. Certificate	
								MII KERN	€	DKD KERN	€
PFB 120-3	120	0,001	-	0,001	± 0,003	A	280,-	-	-	963-127	72,-
PFB 200-3	200	0,001	-	0,001	± 0,003	A	290,-	-	-	963-127	72,-
PFB 300-3	300	0,001	-	0,002	± 0,003	A	320,-	-	-	963-127	72,-
PFB 1200-2	1200	0,01	-	0,01	± 0,03	B	245,-	-	-	963-127	72,-
PFB 2000-2	2000	0,01	-	0,01	± 0,03	B	255,-	-	-	963-127	72,-
PFB 3000-2	3000	0,01	-	0,01	± 0,03	B	280,-	-	-	963-127	72,-
PFB 6K0.05	6000	0,05	-	0,05	± 0,15	C	250,-	-	-	963-128	88,-
PFB 6000-1	6000	0,1	-	0,1	± 0,3	C	220,-	-	-	963-128	88,-
Note: For applications that require verification, please order verification at the same time, initial verification at a later date is not possible. Verification at the factory, we need to know the full address of the location of use.											
PFB 600-2M	600	0,01	0,1	0,01	± 0,02	B	270,-	965-216	66,-	963-127	72,-
PFB 600-1M 1	600	0,1	0,1	0,1	± 0,1	B	340,-	965-216	66,-	963-127	72,-
PFB 6000-1M	6000	0,1	1	0,1	± 0,3	C	260,-	965-217	77,-	963-128	88,-
PFB 6000-0M 1	6000	1	1	1	± 1	C	330,-	965-217	77,-	963-128	88,-



High-resolution precision balance with high resolution and large range of functions

Features

- With its exceptionally large weighing ranges and readouts, this range offers a large pool of products to cover the most varied applications within the laboratory environment. They are therefore particularly suitable for heavy tare containers or large samples
- Stable weighing results thanks to the individual temperature compensation of the strain gauge measuring system which is set at the factory. It is therefore especially suitable for use in areas where there are temperature fluctuations
- The measuring system's exceptionally high resolution of 420,000 points ensures the highest level of accuracy with large weighing ranges. Almost unbeatable in this price category
- **Compact size**, practical for small spaces
- **Weighing sum memory** sums up individual weighing results

- **Glass draught shield**, standard for models with weighing plate size **A**. Removable metal cover with pipette opening. Weighing space ØxH 125x70 mm

Technical data

- Backlit LCD display, digit height 15 mm
- Weighing plate dimensions, stainless steel, **A** Ø 80 mm, **B** Ø 135 mm, see enlarged picture
- Dimensions housing WxDxH 185x250x80 mm
- Net weight approx. 2,5 kg
- Permissible ambient temperature 10 °C / 30 °C

Accessories

- **Rechargeable battery pack internal**, operating time up to 30 h without backlight, charging time approx. 10 h, KERN PLE-A06, **€ 35,-**
- **Set for density determination** of liquids and solids with density $\leq/\geq 1$, similar to illustration. For additional information see page 214. For all models with readout [d] = 0,001 g, KERN ALT-A02, **€ 350,-**
- **RS-232/Ethernet adapter** for connection to an IP-based Ethernet network, for details see page 180, KERN YKI-01, **€ 390,-**
- **Suitable test weights**, also with calibration certificate see page 188
- **Suitable printers** see page 177 ff.

STANDARD



OPTION



Model	Weighing range [Max]	Readout [d]	Reproducibility	Linearity	Min. piece weight [Counting]	Weighing plate	Price excl. of VAT ex works €	Option DAKKS Calibr. Certificate	
								DKD KERN	€
PLE 420-3N	420	0,001	0,002	± 0,004	0,005	A	450,-	963-127	72,-
PLE 4200-2N	4200	0,01	0,02	± 0,04	0,05	B	450,-	963-127	72,-

Compact laboratory balance KERN KB-N · KB-NM · KBJ



02



Compact precision balance with large weighing range, as well as EC type approval [M] and automatic internal adjustment

Features

- **KERN KBJ with internal automatic adjustment:** Every time the balance is restarted it is adjusted automatically, which guarantees a high degree of accuracy and makes it independent of its location
- Ideal for mobile applications which require verification, such as ambulatory gold and jewellery purchasing
- **User guidance step by step** on display by Yes/No dialogue
- **Freely programmable weighing unit**, e.g. display direct in special units such as length of thread g/m, grammage g/m², or similar

- **Ring-shaped draught shield** standard, only for models with weighing plate size **A**, weighing space ØxH 90x40 mm

Technical data

- Backlit LCD display, digit height 9 mm
- Weighing plate dimensions, stainless steel*
 - A** Ø 81 mm, plastic, with conductive lacquer
 - B** WxD 130x130 mm*
 - C** WxD 150x170 mm*, see enlarged picture
- Overall dimensions without draught shield WxDxH 167x250x85 mm
- Net weight approx. 2 kg
- Permissible ambient temperature
 - KERN KB-N: 10 °C / 40 °C
 - KERN KB-NM, KBJ: 10 °C / 30 °C

Accessories

- **Protective working cover** over keyboard and housing, standard. Can be re-ordered, scope of delivery: 5 items, **€ 30,-** for models with weighing plate size **A** KERN PCB-A02S05, **B** KERN PCB-A04S05 **C** KERN PCB-A05S05
- **Rechargeable battery pack internal**, 15 h, charging time approx. 10 h, KERN KB-A01N, **€ 50,-**
- only KB-N: **Rechargeable battery pack external**, operating time up to 15 hours with backlight, charging time approx. 10 h, KERN KS-A01, **€ 180,-**
- **Suitable test weights**, also with calibration certificate see page 188
- **Suitable printers** see page 177 ff.

STANDARD



OPTION



FACTORY



Model	Weighing range [Max] g	Readout [d] g	Verification value [e] g	Reproducibility g	Linearity g	Weighing plate	Price excl. of VAT ex works €	Options			
								Verification		DAkkS Calibr. Certificate	
								M II KERN	€	DKD KERN	€
KB 120-3N	120	0,001	-	0,001	± 0,003	A	270,-	-	-	963-127	72,-
KB 240-3N	240	0,001	-	0,001	± 0,003	A	280,-	-	-	963-127	72,-
KB 360-3N	360	0,001	-	0,002	± 0,005	A	300,-	-	-	963-127	72,-
KB 1200-2N	1200	0,01	-	0,01	± 0,03	B	270,-	-	-	963-127	72,-
KB 2000-2N	2000	0,01	-	0,01	± 0,03	B	270,-	-	-	963-127	72,-
KB 2400-2N	2400	0,01	-	0,01	± 0,03	B	280,-	-	-	963-127	72,-
KB 3600-2N	3600	0,01	-	0,02	± 0,05	B	290,-	-	-	963-127	72,-
KB 10K0.05N	10000	0,05	-	0,05	± 0,15	C	280,-	-	-	963-128	88,-
KB 10000-1N	10000	0,1	-	0,1	± 0,3	C	260,-	-	-	963-128	88,-
Note: For applications that require verification, please order verification at the same time, initial verification at a later date is not possible. Verification at the factory, we need to know the full address of the location of use.											
KB 650-2NM	650	0,01	0,1	0,01	± 0,03	B	320,-	965-216	66,-	963-127	72,-
KB 6500-1NM	6500	0,1	1	0,1	± 0,2	C	320,-	965-217	77,-	963-128	88,-
1 Automatic internal adjustment											
KBJ 650-2NM *	650	0,01	0,1	0,01	± 0,03	B	690,-	965-216	66,-	963-127	72,-

* ONLY WHILE STOCKS LAST !

For more information, please visit kern-sohn.com/en/KB .../KBJ · Order hotline +49 [0] 7433 9933-0

Precision balances



Laboratory specialist with clear graphics display for the most simple user guidance

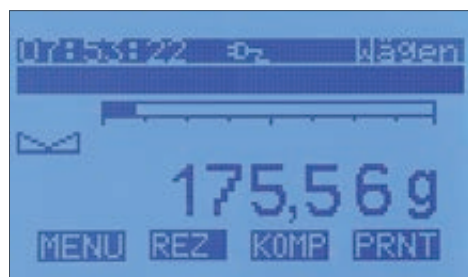

Large backlit graphic display

All relevant information for the mode you are using is displayed clearly, at a glance and assigned to the keys are assigned on the keyboard overlay

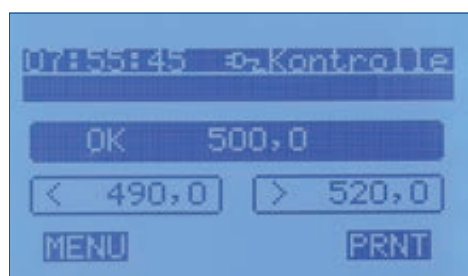

Weighing with tolerance range

(checkweighing): Input of an upper/lower limit value. A visual signal assists with portioning, dispensing or grading

Convenient recipe weighing

you can save up to 5 complete recipes in the memory with up to 7 components of each. The individual components of a mixture can be printed out clearly with their name, weight and grand total

GLP/ISO record keeping of weighing data,

balance adjustment, etc. with date, time and identification no. etc. Ideal for monitoring and documenting your processes in accordance with your quality management system

Compact laboratory balance KERN PKS



Features

- Based on the KERN bestseller KB, many typical laboratory functions have been expanded to include a clear graphic screen, which shows the relevant information and makes it significantly easier to operate and read the weights off the display
- **Navigation pad** for super quick navigating through the menus
- **40 memories for each operation mode**
- Extensive print formatting – up to 20 lines with fixed and variable texts
- **Freely programmable weighing unit**, e.g. display direct in special units such as length of thread g/m, paper weight g/m², or similar
- **High mobility**: thanks to rechargeable battery operation (optional), compact, lightweight construction, it is suitable for the use in several locations (laboratory, production, quality control, commissioning etc.)
- **Ring-shaped draught shield** standard for models with weighing plate size **A**, weighing space ØxH 90x53 mm
- **Hook for underfloor weighing** of hanging loads standard

Technical data

- Large backlit LCD graphic display, screen diagonal 3,2" (approx. 81 mm)
- Weighing plate dimensions, stainless steel,
 - A** Ø 81 mm
 - B** WxD 130x130 mm
 - C** WxD 150x170 mm, see enlarged picture
- Weighing plate material
 - A** Plastic, with conductive lacquer
 - B, C** Stainless steel
- Dimensions housing WxDxH 167x250x85 mm
- Permissible ambient temperature 10 °C / 40 °C

Accessories

- **Protective working cover** over keyboard and housing, standard. Can be re-ordered, scope of delivery: 5 items, **€ 30,-** for models with weighing plate size
 - A** KERN PCB-A02S05
 - B** KERN PCB-A04S05
 - C** KERN PCB-A05S05
- **Rechargeable battery pack external**, operating time up to 15 hours with backlight, charging time approx. 10 h, KERN KS-A01, **€ 180,-**
- **Rechargeable battery pack internal**, operating time up to 10 hours with backlight, charging time approx. 10 h, KERN KB-A01N, **€ 50,-**
- **RS-232/Ethernet adapter** for connection to an IP-based Ethernet network, for details see page 180, KERN YKI-01, **€ 390,-**
- **Suitable test weights**, also with calibration certificate see page 188
- **Suitable printers** and further, extensive accessories from page 177 ff.

Modes

- ① Weighing
- ② Counting
- ③ Dispensing
- ④ Recipe weighing
- ⑤ Checkweighing
- ⑥ Totalising with daily total
- ⑦ Percentage determination
- ⑧ Animal weighing
- ⑨ Surface weight

Functions

- Capacity display, with ① - ②, ⑤ - ⑦, ⑨
- Dispensing aid (-/+), with ③, ④
- Net/gross display, permanent, with ①, ③ - ⑤, ⑧ - ⑨
- Variable reference quantity, with ②
- Automatic reference optimisation, with ②
- PRE-TARE numerical or from the memory unit, with ① - ⑦
- Input of item or batch description, operator etc., with ① - ⑦
- Freely programmable weighing unit, e.g. display direct in special units such as length of thread g/m, grammage g/m², or similar, with ⑨
- Date/time, with ① - ⑨
- Statistical function, with ①
- GLP printout, with ① - ⑨
- Individual printout configuration ① - ⑨

STANDARD



OPTION



Model	Weighing range [Max] g	Readout [d] g	Reproducibility g	Linearity g	Min. piece weight [Counting] g/piece	Net weight approx. kg	Weighing plate	Price excl. of VAT ex works €	Option DAKkS Calibr. Certificate	
									DKD KERN	€
PKS 200-3	200	0,001	0,001	± 0,003	0,001	1,1	A	420,-	963-127	72,-
PKS 360-3	360	0,001	0,002	± 0,005	0,001	1,1	A	430,-	963-127	72,-
PKS 2000-2	2000	0,01	0,01	± 0,03	0,01	1,5	B	430,-	963-127	72,-
PKS 3600-2	3600	0,01	0,02	± 0,05	0,01	1,5	B	440,-	963-127	72,-
PKS 10K0.1	10000	0,1	0,1	± 0,3	0,1	1,7	C	400,-	963-128	88,-

ONLY WHILE STOCKS LAST !

For more information, please visit kern-sohn.com/en/PKS · Order hotline +49 [0] 7433 9933-0

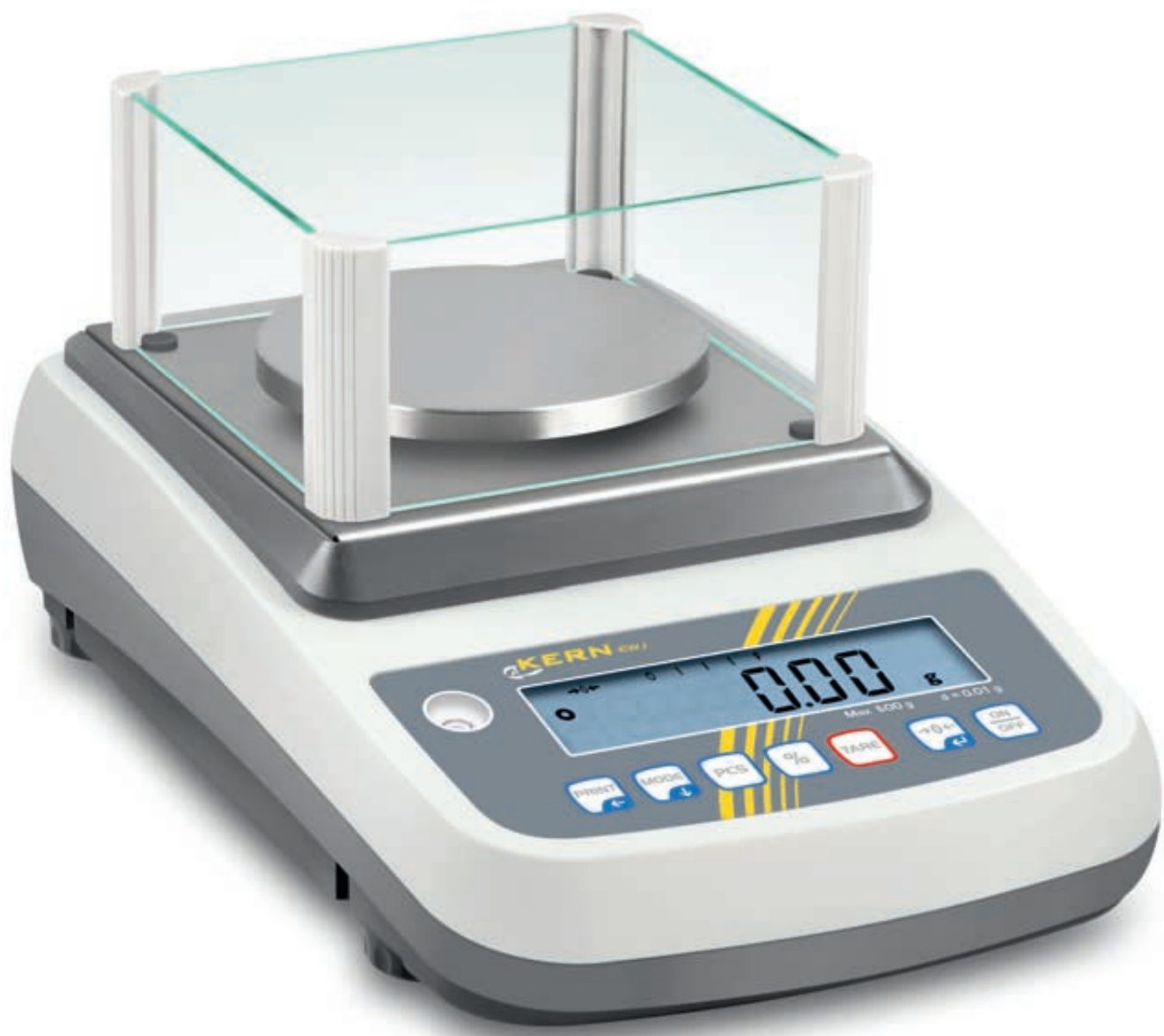

High-quality precision balance with automatic internal adjustment, also with EC type approval [M]



Automatic internal adjustment:
Ideal for mobile applications which require verification, such as ambulatory gold and jewellery purchasing

USB data interfaces for transferring weighing data to the PC, printer, USB sticks, etc.

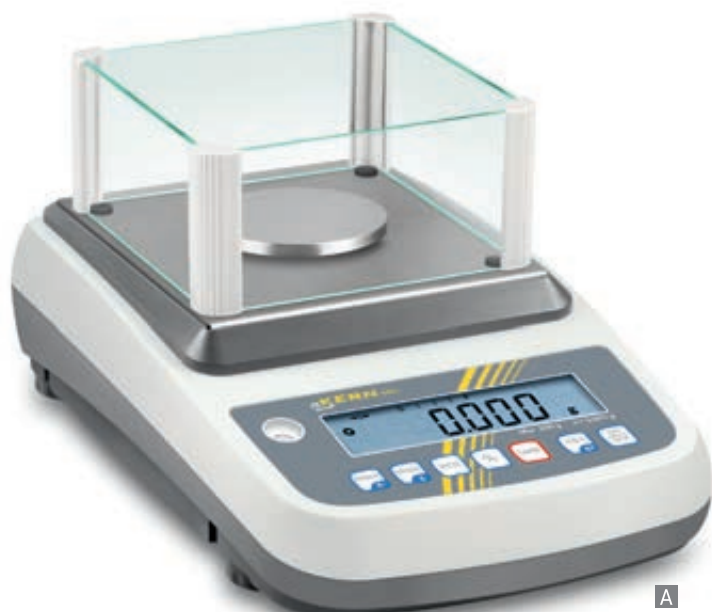

A

C

Features

- **Easy to use:** All primary functions have their own key on the keypad
- **Automatic internal adjustment** time-controlled every 4 hours. Guarantees high degree of accuracy and makes the balance independent of its location
- **Capacity display:** A bar lights up to show how much of the weighing range is still available
- **Draught shield** standard for models with weighing plate size [Max] ≤ 600 g weighing space WxDxH 145x160x80 mm

Technical data

- Large backlit LCD display, digit height 16,5 mm
- Weighing plate dimensions, stainless steel,
 - A Ø 80 mm
 - B Ø 135 mm
 - C WxD 155x145 mm
- Overall dimensions WxDxH without draught shield 220x315x90 mm incl. draught shield 220x315x180 mm
- Permissible ambient temperature 5 °C / 40 °C

Accessories

- **Protective working cover** over keyboard and housing, standard. Can be re-ordered, scope of delivery: 5 items, KERN EWJ-A04S05, € 30,-
- **Rechargeable battery pack internal**, operating time up to 15 h without backlight, charging time approx. 4 h, KERN KFB-A01, € 35,-
- **USB interface kit** for bi-directional data exchange between balance and computer. Scope of delivery: USB cable, driver, Software Balance Connection, KERN DBS-A02, € 290,-
- **RS-232/Ethernet adapter** to connect balances with an RS-232 interface to a network via Ethernet, for details see page 180, KERN YKI-01, € 390,-
- **RS-232/WiFi adapte** for wireless connection to networks and WLAN capable devices, such as tablets, laptops or smartphones, for details see page 180, KERN YKI-03, € 780,-
- **Suitable printers** and further, extensive accessories from page 177 ff.

STANDARD

CAL INT
 RS 232
 USB
 GLP
 PRINTER
 PCS
 RECIPE
 PERCENT
 UNIT
 MULTI
 DMS
 1 DAY
 3 YEARS WARRANTY

only with DBS-A02

OPTION

ACCU
 DAKKS
 +3 DAYS

FACTORY

M
 +3 DAYS
only EWJ-M

Model	Weighing range [Max] g	Readout [d] g	Verification value [e] g	Minimum load [Min] g	Linearity g	Weighing plate	Price excl. of VAT ex works €	Options			
								Verification		DAkkS Calibr. Certificate	
KERN								KERN	€	KERN	€
EWJ 300-3	300	0,001	-	-	± 0,003	A	465,-	-	-	963-127	72,-
EWJ 3000-2	3000	0,01	-	-	± 0,05	B	445,-	-	-	963-127	72,-
Note: For applications that require verification, please order verification at the same time, initial verification at a later date is not possible. Verification at the factory, we need to know the full address of the location of use.											
EWJ 600-2M	600	0,01	0,1	0,5	± 0,03	B	410,-	965-216	66,-	963-127	72,-
EWJ 6000-1M	6000	0,1	1	5	± 0,3	C	400,-	965-217	77,-	963-128	88,-



All-rounder e.g. as precision balance in the laboratory or in harsh industrial applications, also with EC type approval [M]

Features

- Thanks to the **many typical laboratory functions**, such as, for example, recipe function, percentage determination, GLP record keeping, combined with the high level of precision, the KERN 572 is a reliable partner for day-to-day work in the laboratory.
- The **robust version**, typical industrial functions, such as piece-counting, vibration-free weighing and the large weighing ranges also make these balances ideal for all industrial applications, where a high level of precision is required

- **Freely programmable weighing unit**, e.g. display direct in special units such as length of thread g/m, paper weight g/m², or similar
- **The robust aluminium diecast housing** maintains the stability, protects the weighing technology elements and is robust enough to cope with everyday use
- only 572: **Ring-shaped draught shield** standard (Weighing plate **A**), weighing space ØxH 157x43 mm
- Hook for underfloor weighing, for models with [d] ≥ 0,01 g, can be retrofitted, KERN 572-A03, **€ 25,-**
- **UNITS:** Further weighing units see the internet (only 572)

Technical data

- Large backlit LCD display, digit height 18 mm
- Weighing plate dimensions, stainless steel, **A** Ø 106 mm **B** Ø 150 mm **C** WxD 160x200 mm, see enlarged picture
- Overall dimensions WxDxH 180x310x130 mm
- Permissible ambient temperature
KERN 572: 10 °C / 40 °C
KERN 573: 10 °C / 30 °C

Accessories

- **Protective working cover** standard. Can be re-ordered, scope of delivery: 5 items, KERN 572-A02S05, **€ 35,-**
- **only 572: Rechargeable battery pack external**, operating time up to 25 h, charging time approx. 10 h, KERN KS-A01, **€ 180,-**
- **Large glass draught shield** with 3 sliding doors for easy access to the items being weighed. Weighing space WxDxH 150x140x130 mm (only for models with weighing plate size **A**), KERN 572-A05, **€ 220,-**
- **Suitable printers** see page 177 ff.

STANDARD

OPTION

FACTORY

Model	Weighing range [Max] g	Readout [d] g	Verification value [e] g	Linearity g	Reproducibility g	Net weight approx. kg	Weighing plate	Price excl. of VAT ex works €	Options			
									Verification		DAkkS Calibr. Certificate	
									MII KERN	€	DKD KERN	€
572-30	240	0,001	-	± 0,003	0,001	2,3	A	520,-	-	-	963-127	72,-
572-31	300	0,001	-	± 0,005	0,002	2,3	A	520,-	-	-	963-127	72,-
572-32	420	0,001	-	± 0,005	0,002	2,3	A	540,-	-	-	963-127	72,-
572-33	1600	0,01	-	± 0,03	0,01	2,3	B	480,-	-	-	963-127	72,-
572-35	2400	0,01	-	± 0,03	0,01	2,3	B	490,-	-	-	963-127	72,-
572-37	3000	0,01	-	± 0,05	0,02	2,3	B	490,-	-	-	963-127	72,-
572-39	4200	0,01	-	± 0,05	0,02	2,3	B	520,-	-	-	963-127	72,-
572-45	12000	0,05	-	± 0,15	0,05	2,7	C	490,-	-	-	963-128	88,-
572-55	20000	0,05	-	± 0,15	0,1	2,7	C	520,-	-	-	963-128	88,-
572-43	10000	0,1	-	± 0,3	0,1	2,7	C	480,-	-	-	963-128	88,-
572-49	16000	0,1	-	± 0,3	0,1	2,7	C	480,-	-	-	963-128	88,-
572-57	24000	0,1	-	± 0,3	0,1	2,7	C	490,-	-	-	963-128	88,-

Note: For applications that require verification, please order verification at the same time, initial verification at a later date is not possible. Verification at the factory, we need to know the full address of the location of use.



Range of precision balances with enormous weighing ranges – ideal for heavy tare containers or large samples

Features

- **A New: PLJ 2000-3A high-quality milligram balance with enormous weighing range up to 2100 g** – ideal for large samples or heavy tare containers
- **2 KERN PLJ: Automatic internal adjustment**, guarantees high degree of accuracy and makes the balance independent of its location of use. Ideal for mobile applications which require verification, such as ambulatory gold and jewellery purchasing

- **3 KERN PLS: Adjusting program CAL** for quick setting of the balance accuracy, external test weights at an additional price, see page 188 ff.
- **Ergonomically optimised keypad** for left and righthanded users
- **Glass draught shield**, standard for models with weighing plate size **A**. Removable metal cover with pipette opening, weighing space ØxH 150x60 mm

Technical data

- Backlit LCD display, digit height 17 mm

- Weighing plate dimensions, stainless steel, **A** Ø 80 mm, **B** Ø 110 mm
C Ø 160 mm, see enlarged picture
D WxD 200x175 mm
- Overall dimensions WxDxH without draught shield: 210x340x100 mm with draught shield: 210x340x160 mm
- **4** KERN PLS/PLJ-F: Strain gauge
- **5** KERN PLS/PLJ-A: Force compensation
- Permissible ambient temperature 5 °C / 35 °C

Accessories

- **Protective working cover** standard. Can be re-ordered, scope of delivery: 5 items, KERN PLJ-A01S05, € 60,-
- **6 Hook for underfloor weighing** of hanging loads, not included, KERN PLJ-A02, € 30,-
- **Set for density determination** of liquids and solids with density ≤ 1 . The density, is indicated directly on all models with readout [d] = 0,001 g, KERN ALT-A02, € 350,- on all models with readout [d] = 0,01 g, KERN PLT-A01, € 350,-
- **RS-232/Ethernet adapter** for connection to an IP-based Ethernet network, for details see page 180, KERN YKI-01, € 390,-
- **Suitable test weights**, also with calibration certificate, see page 188
- **Suitable printers** and further, extensive accessories from page 177 ff.

STANDARD



OPTION



FACTORY



Model	Weighing range [Max] g	Readout [d] g	Verific. value [e] g	Reproducibility g	Linearity g	Min. piece weight [Counting] g/piece	Weighing plate	Net weight approx. kg	Price excl. of VAT ex works €	Options			
										Verification		DAkkS Calibr. Certificate	
										M II KERN	€	DKD KERN	€
PLS 420-3F	420	0,001	-	0,001	± 0,004	0,005	B	2,7	590,-	-	-	963-127	72,-
PLS 720-3A	720	0,001	-	0,001	± 0,002	0,005	B	4,6	850,-	-	-	963-127	72,-
PLS 1200-3A	1200	0,001	-	0,001	± 0,003	0,005	B	4,7	870,-	-	-	963-127	72,-
PLS 4200-2F	4200	0,01	-	0,01	± 0,04	0,05	C	3,0	590,-	-	-	963-127	72,-
PLS 6200-2A	6200	0,01	-	0,01	± 0,03	0,05	C	4,5	870,-	-	-	963-128	88,-
PLS 8000-2A	8200	0,01	-	0,01	± 0,04	0,01	C	4,7	1050,-	-	-	963-128	88,-
PLS 20000-1F	20000	0,1	-	0,1	± 0,4	0,5	D	3,5	590,-	-	-	963-128	88,-
PLJ 420-3F	420	0,001	-	0,001	± 0,003	0,005	B	3,5	700,-	-	-	963-127	72,-
PLJ 720-3A	720	0,001	-	0,001	± 0,002	0,001	B	4,9	990,-	-	-	963-127	72,-
PLJ 1200-3A	1200	0,001	-	0,001	± 0,003	0,005	B	5,0	1005,-	-	-	963-127	72,-
PLJ 2000-3A	2100	0,001	-	0,002	± 0,004	0,05	A	6,5	1700,-	-	-	963-127	72,-
PLJ 4200-2F	4200	0,01	-	0,02	± 0,04	0,05	C	3,8	690,-	-	-	963-127	72,-
PLJ 6200-2A	6200	0,01	-	0,01	± 0,03	0,01	C	5,3	990,-	-	-	963-128	88,-
Note: For applications that require verification, please order verification at the same time, initial verification at a later date is not possible. Verification at the factory, we need to know the full address of the location of use.													
PLJ 720-3AM	720	0,001	0,01	0,001	± 0,002	0,001	B	4,9	1050,-	965-216	66,-	963-127	72,-
PLJ 3000-2FM	3100	0,01	0,1	0,01	± 0,03	0,05	C	4,0	660,-	-	-	963-127	72,-
PLJ 6200-2AM	6200	0,01	0,1	0,01	± 0,03	0,01	C	5,2	1050,-	965-217	77,-	963-128	88,-

NEW New model

NEW



The new standard in the laboratory with robust tuning fork weighing system

Features

- **1** only PNJ: **Automatic internal adjustment**, guarantees high degree of accuracy and makes the balance independent of its location of use. Ideal for mobile applications which require verification, such as ambulatory gold and jewellery purchasing
- **2** only PNS: **Adjusting program CAL** for quick setting of the balance accuracy using an external test weight
- **High-quality tuning fork measuring system** for steady weight values and continuous weighing
- **Capacity display:** A bar lights up to show how much of the weighing range is still available
- **Precise counting:** The automatic reference weight optimisation of reference weight gradually improves the average piece weight value
- **Totalising** of pieces when counting

- **Compact size**, practical for small spaces
- Large stainless steel-weighing plate, removable
- **Large glass draught shield** with 3 sliding doors for easy access to the items being weighed, for models with weighing plate size **A**, weighing space WxDxH 172x171x160 mm

Technical data

- Large LCD display, digit height 16,5 mm
- Weighing plate dimensions, stainless steel, **A** Ø 140 mm **B** WxD 190x190 mm, see enlarged picture
- Overall dimensions WxDxH for models with weighing plate size **A** 202x293x266 mm **B** 196x293x89 mm
- Net weight for models with weighing plate size **A** Net weight approx. 4,2 kg **B** Net weight approx. 3,5 kg
- Permissible ambient temperature 5 °C / 35 °C

Accessories

- **Protective working cover** over keyboard and housing, standard. Can be re-ordered, scope of delivery: 5 items, KERN PNJ-A01S05, **€ 50,-**
- **3** **Precious stones plate**, aluminium with practical spout, WxDxH 83x66x23 mm, KERN AEJ-A05, **€ 40,-**
- **RS-232/Ethernet adapter** for connection to an IP-based Ethernet network, for details see page 180, KERN YKI-01, **€ 390,-**
- **RS-232/Bluetooth adapter** to connect to Bluetooth capable devices, such as Bluetooth printers, tablets, laptops, smartphones, etc., for details see page 180, KERN YKI-02, **€ 260,-**
- **RS-232/WiFi adapter** for wireless connection to networks and WLAN capable devices, such as tablets, laptops or smartphones, for details see page 180, KERN YKI-03, **€ 780,-**
- **Suitable test weights**, also with calibration certificate see page 188
- **Suitable printers** and further, extensive accessories from page 177 ff.

STANDARD



OPTION



FACTORY



Model	Weighing range [Max] g	Readout [d] g	Verification value [e] g	Minimum load [Min] g	Linearity g	Weighing plate	Price excl. of VAT ex works €	Options			
								Verification		DAkkS Calibr. Certificate	
								M KERN	€	DKD KERN	€
PNS 600-3	620	0,001	-	-	± 0,004	A	590,-	-	-	963-127	72,-
PNS 3000-2	3200	0,01	-	-	± 0,02	B	580,-	-	-	963-127	72,-
PNS 12000-1	12000	0,1	-	-	± 0,2	B	570,-	-	-	963-128	88,-
Note: For applications that require verification, please order verification at the same time, initial verification at a later date is not possible. Verification at the factory, we need to know the full address of the location of use.											
PNJ 600-3M	620	0,001	0,01	0,1	± 0,004	A	720,-	965-201 (U)	110,-	963-127	72,-
PNJ 3000-2M	3200	0,01	0,1	0,5	± 0,02	B	680,-	965-216 (U)	66,-	963-127	72,-
PNJ 12000-1M	12000	0,1	1	5	± 0,2	B	680,-	965-217 (U)	77,-	963-128	88,-



Process reliability thanks to automatic internal adjustment and EC type approval [M]

Features

- **Automatic internal adjustment** in the case of temperature change $\geq 3\text{ °C}$ and time-controlled every 3 hours
- **Draught shield** standard (on all models with readout [d] = 0,001 g). Weighing space WxDxH 140x140x65 mm

PLJ-C:

- **Weighing principle:** Force compensation
- **Alibi memory:** paperless archive of weighing results, see page 214
- **Internal memory** for up to 999 weighing results, 1000 items, 100 container weights, 100 users
- **USB interface** for transferring weighing data to the PC, printer, USB sticks etc.

PLJ-GM:

- **Weighing principle:** Strain gauge
- Rechargeable battery pack internal, standard, operating time up to 35 h, charging time approx. 12 h

Technical data

- Backlit LCD display
PLJ-C: digit height 17 mm
PLJ-G: digit height 19 mm
- Weighing plate dimensions, stainless steel, WxD
A 128x128 mm
B 195x195 mm, see enlarged picture
- Overall dimensions WxDxH without draught shield 206x335x85 mm incl. draught shield 206x335x157 mm
- Net weight approx. 2,95 kg (incl. draught shield approx. 4 kg)
- Permissible ambient temperature 15 °C / 30 °C

Accessories

- **Protective working cover** standard. Can be re-ordered, scope of delivery: 5 items, KERN ALS-A02S05, € 35,-
- **Set for density determination** of liquids and solids with density ≥ 1 , only suitable for models with readout [d] = 0,001 g. The density is indicated directly on the display, sim. to illustration. For interesting facts about density determination see page 214, KERN PLS-A01, € 530,-
- only PLJ-C: **WLAN interface** for wireless connection to networks and WLAN capable devices, such as tablets, laptops or smart-phones, must be ordered at purchase, please ask for delivery time, KERN PLJ-A06, € 135,-
- only PLJ-C: **Alibi memory software** for viewing and saving data from the alibi memory onto a PC connected to the system, KERN PET-A16, € 300,-
- **Suitable test weights**, also with calibration certificate see page 188
- **Suitable printers** and further, extensive accessories from page 177 ff.

STANDARD

OPTION FACTORY

only PLJ-C		only PLJ-C		only PLJ-C																	

Model	Weighing range [Max] g	Readout [d] g	Verification value [e] g	Reproducibility g	Linearity g	Min. piece weight [Counting] g/piece	Weighing plate	Price excl. of VAT ex works €	Options			
									Verification		DAkkS Calibr. Certificate	
									MU KERN	€	DKD KERN	€
PLJ 300-3CM	360	0,001	0,01	0,001	$\pm 0,004$	0,005	A	710,-	965-216	66,-	963-127	72,-
PLJ 600-3CM	600	0,001	0,01	0,002	$\pm 0,004$	0,005	A	750,-	965-216	66,-	963-127	72,-
PLJ 700-3CM	750	0,001	0,01	0,02	$\pm 0,004$	0,005	A	730,-	965-216	66,-	963-127	72,-
PLJ 600-2GM	600	0,01	0,1	0,02	$\pm 0,02$	0,05	A	540,-	965-216	66,-	963-127	72,-
PLJ 3000-2CM	3500	0,01	0,1	0,01	$\pm 0,04$	0,05	B	710,-	965-216	66,-	963-127	72,-
PLJ 6000-1GM	6000	0,1	1	0,2	$\pm 0,2$	0,5	B	540,-	965-217	77,-	963-128	88,-

Note: For applications that require verification, please order verification at the same time, initial verification at a later date is not possible. Verification at the factory, we need to know the full address of the location of use.



Internal memory

- Ring memory for up to 49,152 measuring results (744 measuring results per day!)
- Saved measuring results cannot be changed or cleared. If the maximum memory capacity is reached, then the oldest value will be overwritten
- In addition to the measuring result, the date, time, tare value, a sequential number and the serial number of the balance are also saved.
- Saved measuring results can be searched and recalled easily

Touchscreen laboratory and industrial scale with enormous range of functions

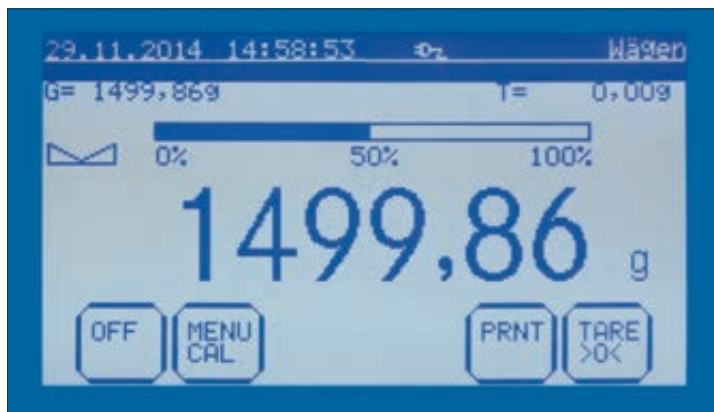

Display at full size, operating mode weighing

Innovative touchscreen: touch-sensitive, backlit screen with very good contrast for easy operation and convenient reading

Advantages:

- The menu and processes are self-explanatory
- No more errors or lost time through keys which have several functions assigned to them or unclear markings
- Large keys, which can also be operated when wearing gloves
- More efficient, faster and safer working



80 memories for each mode

e.g. for Checkweighing, PRE-TARE, reference weight, target value when dispensing, item descriptions, user name, weights for tare containers, etc. Easy to enter using the large-scale keypad

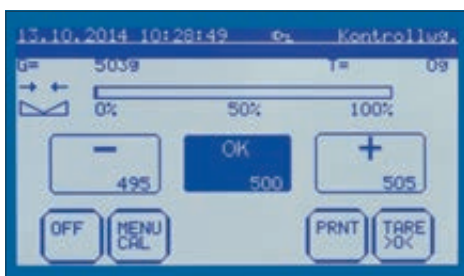

Weighing with tolerance range

(checkweighing): Input of an upper/lower limit value. A visual signal assists with portioning, dispensing or grading



Convenient recipe weighing

you can save up to 99 complete recipes in the memory with up to 10 components each. The individual components of a mixture can be printed out clearly with their name, weight and grand total

Precision balance KERN PKT



A



B



1



3



2

02

Features

- **Convenient recipe-weighing:** the recipes can be generated easily in an Excel list in the PC and transferred to the balance using the RS-232 interface. Alternatively, the recipes can also be entered directly using the keypad. If one recipe ingredient is overweight, then the practical recipe adjustment function for when dosages are exceeded automatically calculates the new target weights of the other ingredients. The actual and target values and the proportionate percentage can then be printed
- **Multiplier function:** recipes with the ingredient weights recorded as percentage values can easily be replicated by entering a new target weight. The ideal solution for the preparation of larger containers, bulk packs etc.
- **16 print forms** which can store up to 20 different information, such as, e.g., date, time, operator, item, net, tare, gross, PCS, target weight, PRE-TARE etc. The print forms can be generated easily in an Excel list in the PC and transferred to the balance using the RS-232 interface
- **Rapid function** for shortened stabilisation time with reduced readout
- **Ring-shaped draught shield** standard for models with weighing plate size **A**, weighing space $\varnothing \times H$ 157x57 mm
- **Hook for underfloor weighing**, standard on all models with readout [d] = 0,001 g

Technical data

- Large backlit LCD touch display, digit height 15 mm, screen diagonal 4,3" (approx. 109 mm), WxH 91x54 mm
- Weighing plate dimensions, stainless steel, **A** \varnothing 106 mm, **B** \varnothing 150 mm
- **C** WxD 160x200 mm, see enlarged picture
- Overall dimensions WxDxH 180x310x90 mm
- Permissible ambient temperature 10 °C / 40 °C

Accessories

- **Protective working cover** standard. Can be re-ordered, scope of delivery: 5 items, KERN 572-A02S05, **€ 35,-**
- **Rechargeable battery pack external**, operating time up to 15 hours with backlight, charging time approx. 10 h, KERN KS-A01, **€ 180,-**
- **Large glass draught shield** with 3 sliding doors. Weighing space WxDxH 150x140x130 mm (only for models with weighing plate size **A**), KERN 572-A05, **€ 220,-**
- **Set for density determination** of liquids and solids with density $\leq/\geq 1$, **2** for models with weighing plate size **A**, KERN YDK-01, **€ 205,-**, **3** for models with weighing plate size **B**, KERN YDK-02, **€ 310,-**
- **RS-232/Ethernet adapter**, for details see page 180, KERN YKI-01, **€ 390,-**
- **RS-232/USB adapter**, for details see page 181, KERN AFH 12, **€ 85,-**
- **Hook for underfloor weighing**, for models with [d] $\geq 0,01$ g, can be retrofitted, KERN 572-A03, **€ 25,-**
- **Suitable printers** see page 177 ff.

Modes

- ① Weighing
- ② Counting
- ③ Dispensing
- ④ Recipe weighing
- ⑤ Checkweighing
- ⑥ Totalising with daily total
- ⑦ Percentage determination
- ⑧ Animal weighing
- ⑨ Surface weight
- ⑩ Density determination, only with **A**, **B**
- ⑪ Rapid function

Functions

- Capacity display, with ① - ②, ⑤ - ⑦, ⑨ - ⑪
- Dispensing aid (subtractive/additive), with ③, ④
- Net/gross display, permanent, with ①, ③ - ⑤, ⑧ - ⑪
- Variable reference quantity, with ②
- Automatic reference optimisation, with ②
- PRE-TARE numerical or from the memory unit, with ① - ⑦, ⑪
- Input of item or batch description, operator etc., with ① - ⑦
- Freely programmable weighing unit, e.g. display direct in special units such as length of thread g/m, grammage g/m², or similar, with ⑨
- Date/time, with ① - ⑪
- Statistical function, with ①
- GLP printout, with ① - ⑪
- Individual formatting of up to 16 printer forms, recipes, operating mode master data in MS Excel, import via RS-232, for examples, see the internet, with ① - ⑪

STANDARD



OPTION

Model	Weighing range [Max] g	Readout [d] g	Reproducibility g	Linearity g	Min. piece weight [Counting] g/piece	Net weight approx. kg	Weighing plate	Price excl. of VAT ex works €	Option DAKKS Calibr. Certificate	
									DKD KERN	€
KERN PKT 300-3	300	0,001	0,002	± 0,005	0,001	2,3	A	740,-	963-127	72,-
KERN PKT 420-3	420	0,001	0,002	± 0,005	0,001	2,3	A	770,-	963-127	72,-
KERN PKT 3000-2	3000	0,01	0,02	± 0,05	0,01	2,3	B	740,-	963-127	72,-
KERN PKT 4200-2	4200	0,01	0,02	± 0,05	0,01	2,3	B	770,-	963-127	72,-
KERN PKT 12K0.05	12000	0,05	0,05	± 0,15	0,05	2,7	C	630,-	963-128	88,-
KERN PKT 16K0.1	16000	0,1	0,1	± 0,3	0,1	2,7	C	630,-	963-128	88,-
KERN PKT 24K0.1	24000	0,1	0,1	± 0,3	0,1	2,7	C	650,-	963-128	88,-

! ONLY WHILE STOCKS LAST !

For more information, please visit kern-sohn.com/en/PKT · Order hotline +49 [0] 7433 9933-0

Precision balances

35



The classic balance with robust tuning fork measuring system



GLP/ISO record keeping of weighing data, balance adjustment, etc. with date, time and identification no. etc. Ideal for monitoring and documenting your processes in accordance with your quality management system

Percentage determination: makes it possible to store a given weight value (100 %) and to determine deviations from this target value

Weighing with tolerance range (checkweighing): a visual signal helps with portioning, dispensing or grading

Precision balances KERN EW-N · EG-N



02

Features

- 1 only EG-NM: **Internal adjustment** by rotary knob on the side. Guarantees high degree of accuracy and makes the balance independent of its location
- 2 only EW-NM: **Adjusting program CAL** for quick setting of the balance accuracy using an external test weight
- Capacity display:** A bar lights up to show how much of the weighing range is still available
- Precise counting:** The automatic reference weight optimisation of reference weight gradually improves the average piece weight value
- Totalising** of pieces when counting
- Draught shield** standard for models with weighing plate size A. Removable metal cover with pipette opening, weighing space WxDxH 158x130x78 mm

Technical data

- Large LCD display, digit height 17 mm
- Weighing plate dimensions, stainless steel,
 - A Ø 118 mm, see enlarged picture
 - B WxD 170x142 mm
 - C WxD 180x160 mm
- Overall dimensions (without draught shield) WxDxH
 - A, B 182x235x75 mm
 - C 192x265x87 mm
- Net weight approx. 1,3 kg
- Permissible ambient temperature 10 °C / 30 °C

Accessories

- Protective working cover** over keyboard and housing, standard. Can be re-ordered, scope of delivery: 5 items. For models with weighing plate size
 - A, B KERN EG-A05S05, € 50,-
 - C KERN EG-A09S05, € 50,-
- Precious stones plate**, aluminium with practical spout, WxDxH 83x66x23 mm, KERN AEJ-A05, € 40,-

- 4 **Rechargeable battery pack internal**, operating time up to 32 h without backlight, charging time approx. 12 h. AUTO-OFF function to preserve the battery, can be switched off. For models with weighing plate size
 - A, B KERN EG-A04, € 110,-
 - C KERN EG-A06, € 110,-
- 3 **Large glass draught shield** with 3 sliding doors for easy access to the items being weighed, weighing space WxDxH 150x140x130 mm, can be retrofitted for models with weighing plate size A, KERN EG-A03, € 235,-
- Loop for underfloor weighing**, not included, for models with weighing plate size
 - A, B KERN EG-A07, € 40,-
 - C KERN EG-A08, € 40,-
- RS-232/Ethernet adapter** for connection to an IP-based Ethernet network, for details see page 180, KERN YKI-01, € 390,-
- Suitable test weights**, also with calibration certificate see page 188
- Suitable printers** and further, extensive accessories from page 177 ff.

STANDARD



OPTION



FACTORY



Model	Weighing range [Max] g	Readout [d] g	Verification value [e] g	Reproducibility g	Linearity g	Weighing plate	Price excl. of VAT ex works €	Options			
								Verification		DAkkS Calibr. Certificate	
								M KERN	€	DKD KERN	€
EW 220-3NM	220	0,001	-	0,001	± 0,002	A	620,-	-	-	963-127	72,-
EW 420-3NM	420	0,001	-	0,001	± 0,003	A	690,-	-	-	963-127	72,-
EW 620-3NM	620	0,001	-	0,001	± 0,003	A	770,-	-	-	963-127	72,-
EW 820-2NM	820	0,01	-	0,01	± 0,01	B	540,-	-	-	963-127	72,-
EW 2200-2NM	2200	0,01	-	0,01	± 0,01	C	660,-	-	-	963-127	72,-
EW 4200-2NM	4200	0,01	-	0,01	± 0,02	C	740,-	-	-	963-127	72,-
EW 6200-2NM	6200	0,01	-	0,01	± 0,03	C	810,-	-	-	963-128	88,-
EW 12000-1NM	12000	0,1	-	0,1	± 0,2	C	635,-	-	-	963-128	88,-

Note: For applications that require verification, please order verification at the same time, initial verification at a later date is not possible. Verification at the factory, we need to know the full address of the location of use.

EG 220-3NM	220	0,001	0,01	0,001	± 0,002	A	760,-	965-216 (U)	66,-	963-127	72,-
EG 420-3NM	420	0,001	0,01	0,001	± 0,003	A	830,-	965-216 (U)	66,-	963-127	72,-
EG 620-3NM	620	0,001	0,01	0,001	± 0,004	A	930,-	965-201 (U)	110,-	963-127	72,-
EG 2200-2NM	2200	0,01	0,1	0,01	± 0,01	C	820,-	965-216 (U)	66,-	963-127	72,-
EG 4200-2NM	4200	0,01	0,1	0,01	± 0,02	C	880,-	965-216 (U)	66,-	963-127	72,-



02



Multifunctional laboratory balance with single-cell weighing system and EC type approval [M]



only PBS: **Adjusting program CAL** for quick setting of the balance accuracy, external test weights at an additional price

Simple recipe weighing and documenting with a combined tare/print function. In addition, the ingredients for the recipe are numbered automatically and printed out with their corresponding number and nominal weight

Percentage determination: makes it possible to store a given weight value (100 %) and to determine deviations from this target value



Features

- **1** only PBJ: **Automatic internal adjustment** in the case of a change in temperature and time-controlled at defined intervals, guarantees high degree of accuracy and makes the balance independent of its location of use. Ideal for mobile applications which require verification, such as ambulatory gold and jewellery purchasing
- **Metal housing:** robust and sturdy
- **Dosage aid:** High-stability mode and other filter settings can be selected
- **Weighing with tolerance range (checkweighing):** Input of an upper/lower limit value. A visual signal assists with portioning, dispensing or grading
- **Totalising** of individual weighing results
- **Identification number:** 4 digits, printed on calibration protocol freely programmable
- **Automatic data output to the PC/printer** each time the balance is steady
- **2** **Draught shield** standard, on all models with readout [d] = 0,001 g, weighing space WxDxH 180x193x87 mm

Technical data

- Large backlit LCD display, digit height 14 mm
- Weighing plate dimensions, stainless steel, WxD
 - A** 108x105 mm
 - B** 180x190 mm, see enlarged picture
- Overall dimensions (without draught shield) WxDxH 200x320x85 mm
- Net weight approx. 3 kg
- Permissible ambient temperature 10 °C / 30 °C

Accessories

- **Protective working cover** over keyboard and housing, standard. Can be re-ordered, scope of delivery: 5 items, **€ 35,-** for models with weighing plate size
 - A** KERN PBS-A01S05
 - B** KERN PBS-A02S05

5 Single-cell advanced technology:

- **Fully automatic manufactured weighing cell from one piece of material**
- **Stable temperature behaviour**
- **Short stabilisation time: 3 sec**
- **Shock proof construction**
- **High corner load performance**

• **4** **Set for density determination** for models with weighing plate size

- A** KERN PBS-A04, **€ 1580,-**
- B** KERN PBS-A03, **€ 1580,-**

For interesting facts about density determination 214

• **RS-232/Ethernet adapter** for connection to an IP-based Ethernet network, for details see page 180, KERN YKI-01, **€ 390,-**

• **Suitable test weights**, also with calibration certificate see page 188

• **Suitable printers** and further, extensive accessories from page 177 ff.

STANDARD

OPTION

FACTORY

only PBJ

Model	Weighing range [Max] g	Readout [d] g	Verification value [e] g	Minimum load [Min] g	Reproducibility g	Linearity g	Weighing plate	Price excl. of VAT ex works €	Options			
									Verification		DAkkS Calibr. Certificate	
KERN								KERN	€	KERN	€	
PBS 620-3M	620	0,001	-	-	0,001	± 0,002	A	1360,-	-	-	963-127	72,-
PBS 4200-2M	4200	0,01	-	-	0,01	± 0,02	B	1150,-	-	-	963-127	72,-
PBS 6200-2M	6200	0,01	-	-	0,01	± 0,02	B	1380,-	-	-	963-128	88,-
PBS 8200-1M*	8200	0,1	-	-	0,1	± 0,2	B	490,-	-	-	963-128	88,-
Note: For applications that require verification, please order verification at the same time, initial verification at a later date is not possible. Verification at the factory, we need to know the full address of the location of use.												
PBJ 620-3M	620	0,001	0,01	0,1	0,001	± 0,002	A	1590,-	965-201	110,-	963-127	72,-
PBJ 4200-2M	4200	0,01	0,1	0,5	0,01	± 0,02	B	1420,-	965-216	66,-	963-127	72,-
PBJ 6200-2M	6200	0,01	0,1	1	0,01	± 0,02	B	1720,-	965-202	110,-	963-128	88,-
PBJ 8200-1M	8200	0,1	1	5	0,1	± 0,2	B	1410,-	965-217	77,-	963-128	88,-

! * ONLY WHILE STOCKS LAST

! Price reduction



Robust laboratory and industrial precision scale for heavy items, with EC type approval [M]

Features

- **2** only PEJ: **Automatic internal adjustment**
- **3** only PES: **Adjusting program CAL** for quick setting of the balance accuracy
- **Metal housing:** robust and sturdy
- **Weighing with tolerance range (checkweighing):** Input of 2 upper and 2 lower limit values through 4 arrow keys. An audible and visual signal assists with the portioning, dispensing or grading
- **1 Draught shield** standard on all models with readout [d] = 0,001 g, weighing space WxDxH 170x150x100 mm. Removable metal cover with pipette opening
- **Underfloor weighing:** load support with hook on the underside of the balance

Technical data

- Fluorescent display, bright with high contrast, digit height 13 mm
- Weighing plate dimensions, stainless steel, WxD
 - A** 140x120 mm
 - B** 200x200 mm, see enlarged picture
 - C** 250x220 mm
- Overall dimensions (without draught shield) WxDxH
 - A** 220x330x90 mm
 - B** 220x333x93 mm
 - C** 260x330x113 mm
- Permissible ambient temperature 10 °C / 30 °C

Accessories

- **Protective working cover** standard. Can be re-ordered, scope of delivery: 5 items (not for KERN PES 31000-1M), KERN PES-A04S05, **€ 55,-**
- only PES: **Rechargeable battery pack internal**, operating time up to 6 h, charging time approx. 15 h (internal charging via mains adapter), KERN PES-A01, **€ 610,-**
- **Relay output** with 5 outputs for weighing in 3 tolerance ranges, must be ordered at purchase, KERN PES-A02, **€ 480,-**
- **RS-232/Ethernet adapter** for connection to an IP-based Ethernet network, for details see page 180, KERN YKI-01, **€ 390,-**
- **Suitable printers** see page 177 ff.

STANDARD

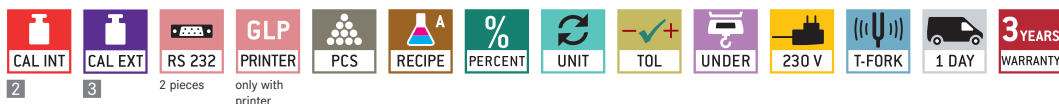

OPTION



FACTORY



Model	Weighing range [Max] g	Readout [d] g	Verification value [e] g	Reproducibility g	Linearity g	Net weight approx. kg	Weighing plate	Price excl. of VAT ex works €	Options			
									Verification		DAkkS Calibr. Certificate	
KERN								M KERN	€	DKD KERN	€	
PES 620-3M	620	0,001	-	0,001	± 0,003	4	A	1280,-	-	-	963-127	72,-
PES 2200-2M	2200	0,01	-	0,01	± 0,02	4	B	830,-	-	-	963-127	72,-
PES 4200-2M	4200	0,01	-	0,01	± 0,02	4	B	980,-	-	-	963-127	72,-
PES 6200-2M	6200	0,01	-	0,01	± 0,03	4	B	1210,-	-	-	963-128	88,-
PES 15000-1M	15000	0,1	-	0,1	± 0,2	4	B	1190,-	-	-	963-128	88,-
PES 31000-1M	31000	0,1	-	0,1	± 0,4	8,9	C	1960,-	-	-	963-128	88,-

Note: For applications that require verification, please order verification at the same time, initial verification at a later date is not possible. Verification at the factory, we need to know the full address of the location of use.

PEJ 620-3M	620	0,001	0,01	0,001	± 0,003	6	A	1480,-	965-201	110,-	963-127	72,-
PEJ 2200-2M	2200	0,01	0,1	0,01	± 0,02	6	B	1040,-	965-216	66,-	963-127	72,-
PEJ 4200-2M	4200	0,01	0,1	0,01	± 0,02	6	B	1190,-	965-216	66,-	963-127	72,-

Premium precision balance KERN PET

PREMIUM



KERN PET [d] = 0,001 g



KERN PET [d] = 0,01 g

02

Premium touchscreen precision balance with the complete range of functions for demanding processes



Individual print formats: Printouts can be individually adjusted depending on operating mode, application or your own requirements, directly at the balance or the PC. In this way the data related to these processes is documented accurately, efficiently and clearly



Convenient recipe-weighing: complete recipes with all recipe ingredients and associated target values, names, tolerances, tare weights etc. can be stored. If one recipe ingredient is overweight, then the practical recipe adjustment function for when dosages are exceeded automatically calculates the new target weights of the other ingredients

Modes

- ① Weighing
- ② Piece counting
- ③ Checkweighing
- ④ Dispensing
- ⑤ Percentage determination
- ⑥ Density
- ⑦ Animal weighing
- ⑧ Recipe weighing
- ⑨ Statistics
- ⑩ Pipette calibration
- ⑪ Differential weighing
- ⑫ Statistical Quality Control (SQC)

Funcitons

- Capacity display, with ① - ⑫
- Dispensing assistance, with ④, ⑤
- Net/Gross display, with ① - ⑫
- Variable reference quantity, with ②
- Automatic reference optimization, with ②
- Tare deduction automatic, with ① - ⑫
- Entering of item or batch description, operator etc., with ① - ⑫
- Freely programmable weighing unit, with ① - ⑫
- Date/time, with ① - ⑫
- Statistical function, as stand-alone application
- GLP printout, with ① - ⑫
- Individual formatting of print-outs, with ① - ⑫



3 rapid assignment keys

for frequently recurring applications, functions, settings or memory contents



2 infrared sensors

to initiate functions such as TARE, zeroing, for carrying out, starting or aborting adjustment, calling up database or menu and much more, without having to touch the balance – just give it a wave!

Customised formatting of printout

a range of printouts which can be edited easily at the PC

High level of connectivity

- 1 x Ethernet
- 2 x RS-232
- 2 x USB
- e.g. for data exchange or connecting barcode or RFID scanners
- Digital I/O (4 in/4 out) e.g. to control machines and plants
- 1 x additional display
- 1 x WLAN (selected models)



Individual user settings can be stored

- User name and number
- Password
- Authorisations
- Menu language (DE, GB, FR, IT, ES, PL)
- User profiles
- Additional guest mode for users without user log-in

Alibi memory

Electronic archiving of weighing results, see also page 214

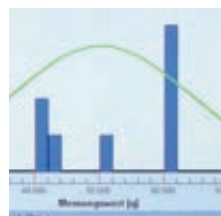
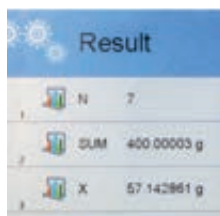

Statistical function

for statistical analysis of series of measurements. The graphic display of measurements can be used by the operator to check and evaluate their results

Intuitive use, increases efficiency and saves costs

Easy capture of article data at the PC, call up of items on the balance using the connected barcode or RFID scanner, output of weighing data using the large or second display or control outputs, data transfer to the PC, printer or alibi memory.

Convenient recipe-weighing

complete recipes with all recipe ingredients and associated nominal values, names, tolerances, tare weights etc. can be stored. If one recipe ingredient is overweight, then the practical recipe adjustment function for when dosages are exceeded automatically calculates the new target weights of the other ingredients. Recipes and their ingredients can be multiplied at will at the press of a button, which is ideal for the production of larger containers, bulk packs etc. (Multiplier function)

Enormous database

with optional software KERN PET-A01, this can be filled in easily at the PC. Particularly beneficial when counting a large number of individual items, as part of a stocktaking, for checkweighing, recording recipes etc.



Data exchange via USB

to download software updates, export recipes or weighing results, export/import databases, balance settings, data exchange between individual balances and much more

Innovative touchscreen

Large backlit and touch-sensitive LCD screen with digit height 17 mm, screen size 5.7" (approx. 145 mm), WxH 115x86 mm. Dimensions of display device WxDxH 208x71x150 mm.

Premium precision balance KERN PET

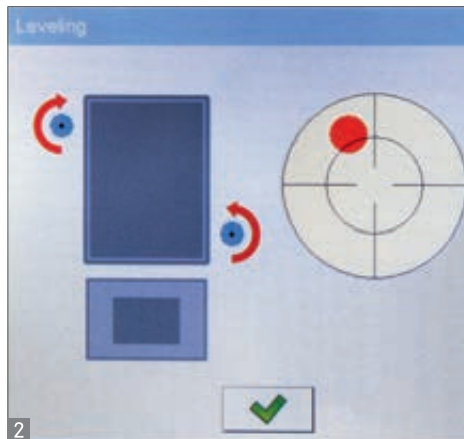

02

Features

- **Intuitive operation, increases efficiency and saves costs:** Easy entering of item data at the PC, call up of items on the balance using the connected **1** barcode or RFID scanner, output of weighing data using the large or second display or control outputs, data transfer to the PC, printer or alibi memory
- **Individual user settings can be stored**
User name and number
 - Password
 - Menu language
 - User profile
 - Additional guest mode for users without log-in
 - Authorisations, e.g. capture or modification of a recipe only with authorisation, recipe weighing can be carried out by the user
- **Best-before dates** can be stored and printed for each item
- **Difference determination:** Weighing a sample before and after a machining process and automatic output of the difference value
- **Multiplier function:** recipes and their ingredients can be multiplied at will at the press of a button, which is ideal for the production of larger containers, bulk packs etc.
- **Enormous database (1 GB)** for thousands of weighing results, items, recipes, recipe ingredients, container weights, user data etc.
- **Alibi memory:** electronic archiving of weighing results, see also page S. 214

- **2 Electronic level indicator** continuously checks the position of the balance, sounds an alarm when the device is out of balance and gives visual instructions on how to correct the situation
- **3 High level of process reliability:** you can define limit values for selected parameters, such as, for example, temperature, levelling, minimum load, adjustment, etc. When the value falls outside these limits, a warning message will be issued and this can be stored with the measuring result
- **Draught shield** standard for models with weighing plate size **A**, weighing space WxDxH 140x140x65 mm

Technical data

- Backlit and touch-sensitive LCD display with digit height 21 mm, screen diagonal 5,7" (approx. 145 mm), WxH 115x86 mm. Dimensions of display device WxDxH 215x156x71 mm
- Hook for underfloor weighing standard
- Weighing plate dimensions, stainless steel, WxD
 - A** 128x128 mm
 - B** 195x195 mm
- Overall dimensions WxDxH
 - A** 431x221x168 mm
 - B** 431x221x99 mm
- Permissible ambient temperature 15 °C / 35 °C

Accessories

- **RS-232 barcode scanner**, hand-held version, dimensions WxDxH 152x84x63 mm, for details see page 184, KERN PET-A05, **€ 350,-**
- **USB barcode scanner**, hand-held version, dimensions WxDxH 152x84x63 mm, for details see page 184, KERN PET-A09, **€ 350,-**
- **USB keyboard** for easy capture of items, descriptions etc., dimensions WxDxH 440x128x24 mm, for details see page 185, KERN PET-A06, **€ 45,-**
- **Second display**, dimensions WxDxH 150x33x80 mm, for details see page 185, KERN PET-A03, **€ 210,-**
- **Direct thermal label printer**, software for easy editing of (adhesive) labels included, for details see page 184, KERN PET-A13, **€ 980,-**
- **Thermal transfer and direct thermal label printer**, software for easy editing of (adhesive) labels included, for details see page 184, KERN PET-A14, **€ 1000,-**
- **Software for database management**, for convenient maintenance of item data at the PC. Data transfer to the balance using the interface cable, for details see page 184, KERN PET-A01, **€ 300,-**
- **Set for density determination** of liquids and solids $\leq/\geq 1$, for details see page 183, KERN YDB-03, **€ 520,-**

STANDARD



OPTION FACTORY

Model	Weighing range [Max] g	Readout [d] g	Verification value [e] g	Minimum load [Min] g	Weighing plate	Price excl. of VAT ex works €	Options			
							Verification		DAkkS-Calibr. Certificate	
KERN							M D KERN	€	DKD KERN	€
PET 600-3M	600	0,001	0,01	0,02	A	2500,-	965-216	66,-	963-127	72,-
PET 1000-3M	1000	0,001	0,01	0,02	A	2800,-	965-216	66,-	963-127	72,-
PET 2500-2M	2500	0,01	0,1	0,5	B	2400,-	965-216	66,-	963-127	72,-
PET 6000-2M	6000	0,01	0,1	0,5	B	2600,-	965-217	77,-	963-128	88,-

Note: For applications that require verification, please order verification at the same time, initial verification at a later date is not possible. Verification at the factory, we need to know the full address of the location of use.

Quick-Finder Analytical balances

Read-out	Weighing range	Model	Price excl. of VAT ex works €	Page	DAYS ready for shipping							
[d]	[Max]	KERN				For an explanation on the pictos, see the front flap						
0,01 mg	100 g	AET 100-5AM	6500,-	50	21		●			●	●	●
0,01 mg	101 g	ABT 100-5M	1980,-	49	1	○	●			●		●
0,01 0,1 mg	42 120 g	ABT 120-5DM	2170,-	49	1	○	●			●		●
0,01 0,1 mg	82 220 g	AEJ 200-5CM	2050,-	48	1	○	●		●	●		●
0,01 0,1 mg	82 220 g	ABT 220-5DM	2370,-	49	1	○	●			●		●
0,01 0,1 mg	82 220 g	AET 200-5DAM	7400,-	50	21		●		●	●	●	●
0,1 mg	82 g	ABS 80-4N	970,-	47	1			●		○		●
0,1 mg	82 g	ABJ 80-4NM	1050,-	47	1	○	●			○		●
0,1 mg	120 g	ABS 120-4N	1030,-	47	1			●		○		●
0,1 mg	120 g	ABJ 120-4NM	1080,-	47	1	○	●			○		●
0,1 mg	120 g	ABT 120-4M	1490,-	49	1	○	●			●		●
0,1 mg	160 g	ALS 160-4A	930,-	46	1			●		●		●
0,1 mg	160 g	ALJ 160-4A	1030,-	46	1			●		●		●
0,1 mg	160 g	ALJ 160-4AM	1050,-	46	1	○	●			●		●
0,1 mg	160 g	AES 100-4C	1070,-	48	1			●	●	●		●
0,1 mg	160 g	AEJ 100-4CM	1150,-	48	1	○	●		●	●		●
0,1 mg	210 g	ADB 200-4	910,-	45	1			●		●		●
0,1 mg	220 g	ABS 220-4N	1070,-	47	1			●		○		●
0,1 mg	220 g	AES 200-4C	1120,-	48	1			●	●	●		●
0,1 mg	220 g	ABJ 220-4NM	1170,-	47	1	○	●			○		●
0,1 mg	220 g	AEJ 200-4CM	1200,-	48	1	○	●		●	●		●
0,1 mg	220 g	ABT 220-4M	1770,-	49	1	○	●			●		●
0,1 mg	220 g	AET 200-4NM	2800,-	50	21	○	●		●	●	●	●
0,1 mg	250 g	ALS 250-4A	980,-	46	1			●		●		●
0,1 mg	250 g	ALJ 250-4A	1060,-	46	1			●		●		●
0,1 mg	250 g	ALJ 250-4AM	1090,-	46	1	○	●			●		●
0,1 mg	310 g	ALJ 310-4A	1290,-	46	1			●		●		●
0,1 mg	320 g	ABS 320-4N	1240,-	47	1			●		○		●
0,1 mg	320 g	ABJ 320-4NM	1340,-	47	1	○	●			○		●
0,1 mg	320 g	ABT 320-4M	1980,-	49	1	○	●			●		●
0,1 mg	510 g	ALJ 500-4A	1950,-	46	1	○	●			●		●
0,1 mg	510 g	AET 500-4	6100,-	50	21		●		●	●	●	●

■ = News 2016

● = Standard

○ = Option



HIGH-LIGHT

Your product specialist's recommendation:



Cable-based display device offers maximum flexibility of operation



Ergonomically optimised design



Large weighing space for high-volume samples or big weighing pans



Bettina Hampe

Product specialist Analytical balances

KERN ADB

only € **910,-**

▶ page 45

Tel. +49 [0] 7433 9933-147

Fax +49 [0] 7433 9933-29147

hampe@kern-sohn.com

NEW



03

The price leader in analytical balances

Features

- Optimised price performance ratio, ideal for laboratories, universities, schools
- **Large glass draught shield** with 3 sliding doors for easy access to the items being weighed. Also ideal for large, light samples such as polystyrene, tissue, plastic parts, etc.
- The **wired display device** can be adjusted differently to suit the ergonomic requirements of the user or the workplace. In addition, it eliminates any heat effect on the weighing system from the display device
- **Ergonomically optimised keypad** for left and righthanded users
- **Percentage determination:** makes it possible to store a given weight value (100 %) and to determine deviations from this target value
- **Adjusting program CAL**, external test weights at an additional price, see page 188 ff.

Technical data

- Large backlit LCD display with digit height 19,6 mm
- Dimensions of weighing plate, stainless steel, Ø 90 mm
- Overall dimensions WxDxH 190x475x295 mm
- Weighing space WxDxH 215x205x295 mm
- External mains adapter standard, EU, GB, AUS
- Cable length of display device approx. 0,5 m
- Permissible ambient temperature 10 °C / 30 °C
- Net weight approx. 6 kg

Accessories

- **Protective working cover**, standard. Can be re-ordered, scope of delivery 5 pieces, KERN ADB-A01S05, **€ 30,-**
- **1 Ioniser** to neutralise electrostatic charge, see page 183, KERN YBI-01, **€ 1350,-**
- **2 Weighing table** to absorb vibrations and oscillations, which would otherwise distort the weighing result, see page 183, KERN YPS-03, **€ 900,-**
- **3 Precious stones plate**, aluminium with practical spout, WxDxH 83x66x23 mm, weighing space, KERN AEJ-A05, **€ 40,-**
- **Suitable printers** and further, extensive accessories from page 177

STANDARD



OPTION



Model	Weighing range [Max] g	Readout [d] mg	Reproducibility mg	Linearity mg	Min. piece weight Counting mg/piece	Price excl. of VAT ex works €	Option DAkKS Calibr. Certificate	
							DKD KERN	€
KERN ADB 200-4	210	0,1	0,2	± 0,4	0,1	910,-	963-101	138,-



Range of analytical balances, with large weighing ranges, also with EC type approval [M]

Features

- 1 only ALJ-A: **Automatic internal adjustment** in the case of a change in temperature > 1,5 °C
- 2 only ALS-A: **Adjusting program CAL** for quick setting of the balance accuracy, external test weights at an additional price, see page 188 ff.
- Ergonomically optimised keypad** for left and righthanded users
- Large glass draught shield** with 3 sliding doors for easy access to the items being weighed
- Compact size**, practical for small spaces
- Percentage determination:** makes it possible to store a given weight value (100 %) and to determine deviations from this target value

Technical data

- Backlit LCD display, digit height 17 mm
- Weighing plate dimensions, stainless steel, Ø 80 mm
- Overall dimensions (incl. draught shield) WxDxH 210x340x330 mm
- Weighing space WxDxH 160x140x205 mm
- Net weight approx. 6,2 kg
- Permissible ambient temperature 5 °C / 35 °C

Accessories

- Protective working cover**, scope of delivery: 5 items, KERN ALJ-A01S05, € 40,-
- Protective dust cover**, KERN ABS-A08, € 30,-

- Set for density determination** of liquids and solids with density ≤ 1 , for details see page 182, KERN YDB-03, € 520,-
- Ioniser** to neutralise electrostatic charge, see page 184, KERN YBI-01, € 1350,-
- Weighing table** to absorb vibrations and oscillations, which would otherwise distort the weighing result, see page 183, KERN YPS-03, € 900,-
- Suitable printers** and further, extensive accessories from page 177 ff.

STANDARD

CAL INT
 CAL EXT
 RS 232
 GLP
 PRINTER
 PCS
 RECIPE
 PERCENT
 UNIT
 TOL
 MOVE
 MULTI
 FORCE
 1 DAY
 3 YEARS WARRANTY

OPTION

DAkkS
 +3 DAYS

FACTORY

M
 +3 DAYS
nur ALJ-AM

Model	Weighing range [Max] g	Readout [d] mg	Verification value [e] mg	Minimum load [Min] mg	Linearity mg	Price excl. of VAT ex works €	Options			
							Verification		DAkkS Calibr. Certificate	
							MT KERN	€	DKD KERN	€
KERN ALS 160-4A	160	0,1	-	-	± 0,3	930,-	-	-	963-101	138,-
KERN ALS 250-4A	250	0,1	-	-	± 0,3	980,-	-	-	963-101	138,-
Note: For applications that require verification, please order verification at the same time, initial verification at a later date is not possible. Verification at the factory, we need to know the full address of the location of use.										
KERN ALJ 160-4A	160	0,1	-	-	± 0,3	1030,-	-	-	963-101	138,-
KERN ALJ 160-4AM	160	0,1	1	10	± 0,3	1050,-	965-201	110,-	963-101	138,-
KERN ALJ 250-4A	250	0,1	-	-	± 0,3	1060,-	-	-	963-101	138,-
KERN ALJ 250-4AM	250	0,1	1	10	± 0,3	1090,-	965-201	110,-	963-101	138,-
KERN ALJ 310-4A	310	0,1	-	-	± 0,3	1290,-	-	-	963-101	138,-
KERN ALJ 500-4A <small>NEW</small>	510	0,1	-	-	± 0,4	1950,-	-	-	963-101	138,-

Price reduction

New model

Analytical balance KERN ABS-N · ABJ-NM



03

- 6** Single-cell advanced technology:
- Fully automatic manufactured weighing cell from one piece of material
 - Stable temperature behaviour
 - Short stabilisation time: Steady weight values within approx. 3 sec under laboratory conditions
 - Shock proof construction
 - High corner load performance

The bestseller in analytical balances, with high-quality single-cell weighing system, also with EC type approval [M]

Features

- **1** only ABJ-NM: **Automatic internal adjustment** in the case of a temperature change > 2 °C and time-controlled every 4 hours
- **2** only ABS-N: **Adjusting program CAL**, external test weights at an additional price, see page 188 ff.
- **Dosage aid:** High-stability mode and other filter settings can be selected
- **Simple recipe weighing and documenting** with a combined tare/print function. In addition, the ingredients for the recipe are numbered automatically and printed out with their corresponding number and nominal weight

- **Automatic data output** to the PC/printer each time the balance has obtained a stable weighing result
- **Identification number:** 4 digits, printed on calibration protocol freely programmable
- ABJ-NM has OIML certification

Technical data

- Large LCD display, digit height 14 mm
- Weighing plate dimensions, stainless steel, Ø 91 mm
- Overall dimensions WxDxH 210x340x325 mm
- Weighing space WxDxH 174x162x227 mm
- Permissible ambient temperature 10 °C / 30 °C
- Net weight approx. 6 kg

Accessories

- **Protective working cover** standard. Can be re-ordered, scope of delivery: 5 items, KERN ACS-A02S05, € 60,-
- **3** **Data interface RS-232** interface cable included, KERN ACS-A01, € 75,-
- **5** **Set for density determination** of liquids and solids with density $\leq/\geq 1$, for details see page 182, KERN YDB-03, € 520,-
- **7** **Ioniser** to neutralise electrostatic charge, see page 184, KERN YBI-01, € 1350,-
- **4** **Weighing table** to absorb vibrations and oscillations, which would otherwise distort the weighing result, see page 184, KERN YPS-03, € 900,-
- **Suitable printers** see page 177 ff.

STANDARD

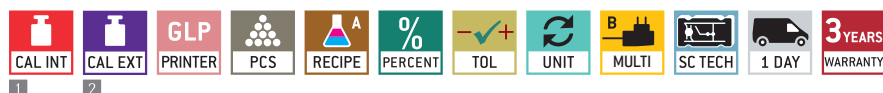

OPTION

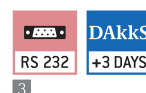

FACTORY



Model	Weighing range [Max] g	Readout [d] mg	Verification value [e] mg	Minimum load [Min] mg	Reproducibility mg	Linearity mg	Price excl. of VAT ex works €	Options			
								Verification		DAkkS Calibr. Certificate	
								M D KERN	€	DKD KERN	€
ABS 80-4N	82	0,1	-	-	0,2	± 0,3	970,-	-	-	963-101	138,-
ABS 120-4N	120	0,1	-	-	0,2	± 0,3	1030,-	-	-	963-101	138,-
ABS 220-4N	220	0,1	-	-	0,2	± 0,3	1070,-	-	-	963-101	138,-
ABS 320-4N	320	0,1	-	-	0,2	± 0,3	1240,-	-	-	963-101	138,-
Note: For applications that require verification, please order verification at the same time, initial verification at a later date is not possible. Verification at the factory, we need to know the full address of the location of use.											
ABJ 80-4NM	82	0,1	1	10	0,2	± 0,3	1050,-	965-201	110,-	963-101	138,-
ABJ 120-4NM	120	0,1	1	10	0,2	± 0,3	1080,-	965-201	110,-	963-101	138,-
ABJ 220-4NM	220	0,1	1	10	0,2	± 0,3	1170,-	965-201	110,-	963-101	138,-
ABJ 320-4NM	320	0,1	1	10	0,2	± 0,3	1340,-	965-201	110,-	963-101	138,-

Price reduction

For more information, please visit kern-sohn.com/en/ABS-N_ABJ-NM · Order hotline +49 [0] 7433 9933-0

Analytical balances

03



Compact high-end analytical balance with useful pipette calibration program and alibi memory

Features

- 1 only AEJ-CM: **Automatic internal adjustment** in the case of a change in temperature > 0,8 °C and time-controlled every 3 hours
- 2 **Intuitive pipette calibration function** to ensure data integrity and to minimise the risks in the daily work with your pipettes
- Higher weighing speed by switching off the last digit
- Modern all glass draught wind shield** for ideal visibility of the weighing object
- Dispensing mode:** By pressing one key you can set all relevant parameters for dispensing
- Alibi memory:** Paperless archiving of up to 100,000 weighing results. Additional information on page 11.

- Note:** For weighings where verification is mandatory, and which are to be analysed and processed by a PC, the legislative body requires electronic archiving using a verifiable, non-manipulatable data memory
- Internal memory** for up to 999 weighing results, 1000 items or recipe ingredients, 100 container weights, 100 users

Technical data

- Large backlit LCD display, digit height 17 mm
- Weighing plate dimensions, stainless steel, Ø 85 mm
- Overall dimensions WxDxH 206x335x335 mm
- Weighing space WxDxH 168x160x225 mm
- Net weight approx. 5 kg
- Permissible ambient temperature 18 °C / 30 °C

Accessories

- Protective working cover**, standard. Can be re-ordered, scope of delivery: 5 items, KERN ALS-A02S05, € 35,-
- Set for density determination** of liquids and solids with density ≤ 1 , Step-by-step user guidance and calculated density shown immediately on the display. For interesting facts about density determination see page 214, KERN YDB-03, € 520,-
- only AEJ-CM: **Alibi memory software** for viewing and saving data from the alibi memory onto a PC connected to the system, KERN PET-A16, € 300,-
- WLAN interface** for wireless connection to networks and WLAN capable devices, such as tablets, laptops or smartphones, must be ordered at purchase, please ask for delivery time, KERN PLJ-A06, € 135,-
- Suitable printers** see page 177 ff.

STANDARD

																	OPTION	FACTORY	
																	+3 DAYS		+3 DAYS

1 only AEJ-CM

Model	Weighing range [Max] g	Readout [d] mg	Verification value [e] mg	Minimum load [Min] mg	Reproducibility mg	Linearity mg	Price excl. of VAT ex works €	Options										
								Verification		DAkKS Calibr. Certificate								
								MT KERN	€	DKD KERN	€							
KERN																		
AES 100-4C	160	0,1	-	-	0,2	± 0,2	1070,-	-	-	963-101	138,-							
AES 200-4C	220	0,1	-	-	0,2	± 0,2	1120,-	-	-	963-101	138,-							
Note: For applications that require verification, please order verification at the same time, initial verification at a later date is not possible. Verification at the factory, we need to know the full address of the location of use.																		
AEJ 200-5CM	82 220	0,01 0,1	1 1	1	0,04 0,1	± 0,1 0,2	2050,-	965-201	110,-	963-101	138,-							
AEJ 100-4CM	160	0,1	1	10	0,2	± 0,3	1150,-	965-201	110,-	963-101	138,-							
AEJ 200-4CM	220	0,1	1	10	0,2	± 0,3	1200,-	965-201	110,-	963-101	138,-							

Analytical balance KERN ABT



03

Single-cell advanced technology:

- Fully automatic manufacture weighing cell from one piece of material
- Stable temperature behaviour
- Short stabilisation time
- Shock proof construction
- High corner load performance

The premium model with single-cell weighing system

Features

- **Automatic internal adjustment** in the case of a change in temperature > 0,5 °C and time-controlled every 4 hours
- **Dosage aid:** High-stability mode and other filter settings can be selected
- **Simple recipe weighing and documenting** with a combined tare/print function. In addition, the ingredients for the recipe are numbered automatically and printed out with their corresponding number and nominal weight
- **Identification number:** 4 digits, printed on calibration protocol freely programmable
- **Automatic data output to the PC/printer** each time the balance is steady

- **Large glass draught shield** with 3 sliding doors for easy access to the items being weighed

Technical data

- Large LCD display, digit height 14 mm
- Weighing plate dimensions Ø 80 mm
- Overall dimensions WxDxH 217x356x338 mm
- Weighing space WxDxH 168x172x223 mm
- Net weight approx. 7 kg
- Permissible ambient temperature 10 °C / 30 °C

Accessories

- **Protective working cover**, standard. Can be re-ordered, scope of delivery: 5 items, KERN ABT-A02S05, € 50,-
- **1 Set for density determination** of liquids and solids with density $\leq/ \geq 1$. The density is indicated directly on the display, for details see page 182, KERN YDB-03, € 520,-
- **2 Ioniser** to neutralise electrostatic charge, see page 184, KERN YBI-01, € 1350,-
- **3 Weighing table** to absorb vibrations and oscillations, which would otherwise distort the weighing result, see page 184, KERN YPS-03, € 900,-
- **Suitable printers** see page 177 ff.

STANDARD



OPTION



FACTORY



Model	Weighing range [Max] g	Readout [d] mg	Verification value [e] mg	Minimum load [Min] mg	Reproducibility mg	Linearity mg	Price excl. of VAT ex works €	Options			
								Verification		DAkkS Calibr. Certificate	
								MT KERN	€	DKD KERN	€
ABT 120-4M	120	0,1	1	10	0,1	± 0,2	1490,-	965-201	110,-	963-101	138,-
ABT 220-4M	220	0,1	1	10	0,1	± 0,2	1770,-	965-201	110,-	963-101	138,-
ABT 320-4M	320	0,1	1	10	0,1	± 0,3	1980,-	965-201	110,-	963-101	138,-
ABT 100-5M	101	0,01	1	1	0,05	± 0,15	1980,-	965-201	110,-	963-101	138,-
Note: For applications that require verification, please order verification at the same time, initial verification at a later date is not possible. Verification at the factory, we need to know the full address of the location of use.											
Dual-range balance switches automatically to the next largest weighing range [Max] and readout [d].											
ABT 120-5DM	42 120	0,01 0,1	1 1	1	0,02 0,1	± 0,05 0,2	2170,-	965-201	110,-	963-101	138,-
ABT 220-5DM	82 220	0,01 0,1	1 1	1	0,05 0,1	± 0,1 0,2	2370,-	965-201	110,-	963-101	138,-

PREMIUM



KERN AET [d] = 0,1 mg

Note for information on further useful functions for this range, please see pages 6 and 7

KERN AET [d] = 0,01 mg

Premium touchscreen analytical balance with the complete range of functions for demanding processes



Software supported pipette calibration in accordance with ISO 8655: The user is guided through the pipette calibration procedure step by step, in accordance with the requirements of the norm. This helps to ensure that the pipetting volumes are correct and minimises the risks in daily pipetting work



Convenient recipe-weighing: complete recipes with all recipe ingredients and associated target values, names, tolerances, tare weights etc. can be stored. If there is an excess amount of one recipe ingredient the practical back calculation function automatically calculates the new target weights of the other ingredients

Modes

- ① Weighing
- ② Piece counting
- ③ Checkweighing
- ④ Dispensing
- ⑤ Percentage determination
- ⑥ Density determination
- ⑦ Animal weighing
- ⑧ Recipe weighing
- ⑨ Statistical function
- ⑩ Pipette calibration
- ⑪ Differential weighing
- ⑫ Statistical Quality Control (SQC)

Functions

- Capacity display, with ① - ⑫
- Dispensing aid, with ④, ⑤
- Net/gross display, permanent, with ① - ⑫
- Variable reference quantity, with ②
- Automatic reference optimisation, with ②
- PRE-TARE numerical or from the memory unit, with ① - ⑫
- Input of item or batch description, operator etc., with ① - ⑫
- Freely programmable weighing unit, e.g. display direct in special units such as length of thread g/m, grammage g/m², or similar, with ① - ⑫
- Date/time, with ① - ⑫
- Statistical function, as stand-alone application
- GLP printout, with ① - ⑫
- Individual printout configuration, with ① - ⑫

Analytical balance KERN AET

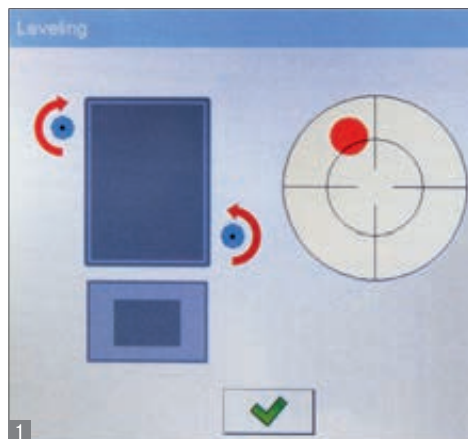

Features

- **Intuitive operation, increases efficiency and saves costs:** Easy entering of item data at the PC, call up of items on the balance using the connected barcode or RFID scanner, output of weighing data using the large or second display or control outputs, data transfer to the PC, printer or alibi memory.
- **Individual user settings can be stored**
 - User name and number
 - Password
 - Menu language
 - User profile
 - Additional guest mode for users without log-in
 - Authorisations, e.g. capture or modification of a recipe only by those with authorisation, recipe weighing can be carried out by the user
- **Best-before dates** can be stored and printed for each item
- **Difference determination:** Weighing a sample before and after a machining process and automatic output of the difference value
- **Multiplier function:** recipes and their ingredients can be multiplied at will at the press of a button, which is ideal for the production of larger containers, bulk packs etc.
- **Enormous database (1 GB)** for thousands of weighing results, items, recipes, recipe ingredients, container weights, user data etc.
- **Alibi memory:** paperless archive of weighing results, see page 214
- **Electronic level indicator** continuously checks the position of the balance, sounds an alarm when the device is out of balance and gives visual instructions on how to correct the situation

- **High level of process reliability:** you can define limit values for selected parameters, such as, for example, temperature, levelling, minimum load, adjustment, etc. When the value falls outside these limits, a warning message will be issued and this can be stored with the measuring result
- **only AET 200-5DM: Grid weighing pan, metal draught shield and hook for suspended weighing** as standard
- **only AET-NM/DAM:**
 - WLAN data interface to transfer data from the balance to a printer, PC or other peripheral devices
 - Enormous database (8 GB)
 - Faster Dual-Core Processor (2 x 1 GB)

Technical data

- Backlit and touch-sensitive LCD display with digit height 21mm, screen diagonal 5,7" (approx. 145 mm), WxH 115x86 mm. Dimensions of display device WxDxH 215x156x71 mm
- Weighing plate dimensions, stainless steel, Ø 85 mm
- Dimensions housing WxDxH on all models with [d] = 0,01 mg: 348x540x217 mm [d] = 0,1 mg: 160x168x225 mm
- Weighing space WxDxH 168x160x225 mm
- Permissible ambient temperature 18 °C / 30 °C

Accessories

- **Protective working cover** over the display device, standard. Can be re-ordered, suitable for the series AET, PET, ILT, scope of delivery: 5 items, KERN ILT-A02S05, € 19,-
- **Protective dust cover**, for models AET 500-4 and AET 200-4NM, KERN ABS-A08, € 30,-
- **RS-232 barcode scanner**, hand-held version, dimensions WxDxH 152x84x63 mm, for details see page 184, KERN PET-A05, € 350,-
- **USB barcode scanner**, hand-held version, dimensions WxDxH 152x84x63 mm, for details see page 184, KERN PET-A09, € 350,-
- **USB keyboard** for easy capture of items, descriptions etc., dimensions WxDxH 440x128x24 mm, for details see page 187, KERN PET-A06, € 45,-
- **Second display**, dimensions WxDxH 150x33x80 mm, for details see page 184, KERN PET-A03, € 210,-
- **Direct thermal label printer**, software for easy editing of (adhesive) labels included, for details see page 184, KERN PET-A13, € 980,-
- **Thermal transfer and direct thermal label printer**, software for easy editing of (adhesive) labels included, for details see page 184, KERN PET-A14, € 1000,-
- **Software for database management**, for convenient maintenance of item data at the PC. Data transfer to the balance using the interface cable (see page 180), for details see page 184, KERN PET-A01, € 300,-
- **Set for density determination** of liquids and solids $\leq/\geq 1$. The internal density determination software in the balance takes you through the process, step by step, and shows the density on the display. For details see page 183, KERN YDB-03, € 520,-

STANDARD



OPTION

Model	Weighing range [Max] g	Readout [d] mg	Verification value [e] mg	Minimum load [Min] mg	Reproducibility mg	Linearity mg	Price excl. of VAT ex works €	Options			
								Verification		DAkkS Calibr. Certificate	
KERN								MT KERN	€	DKD KERN	€
AET 500-4	510	0,1	-	-	0,2	± 0,5	6100,-	-	-	963-101	138,-
Note: For applications that require verification, please order verification at the same time, initial verification at a later date is not possible. Verification at the factory, we need to know the full address of the location of use.											
Dual-range balance switches automatically to the next largest weighing range [Max] and readout [d].											
AET 200-5DAM	82 220	0,01 0,1	-	-	0,04 0,1	± 0,1 0,2	7400,-	-	-	963-101	138,-
AET 100-5AM	100	0,01	-	-	0,05	± 0,1	6500,-	-	-	963-101	138,-
AET 200-4NM	220	0,1	1	10	0,2	± 0,3	2800,-	965-201	110,-	963-101	138,-

Often it is the small things which make daily laboratory life easier.

On this page we have put together a small selection of practical accessories for your demanding weighing processes.

For additional details and further accessories, please see page 176



Weighing table

Accurate measuring results require stable working conditions! The KERN YPS-03 weighing table has been constructed to absorb vibrations and oscillations, which would otherwise distort the weighing result. Suitable for all KERN analytical balances with total dimensions \leq WxD 270x410 mm.

KERN YPS-03, € 900,-

Ioniser to neutralise electrostatic charge

Goods to be weighed which are non-conductive, such as plastic, china, glass, etc often carry electrostatic charge. The electromagnetic field which then occurs between the goods to be weighed and the balance can cause the weighing result to be distorted by up to a gramme. Suitable for all KERN analytical balances.

KERN YBI-01, € 1350,-



Protective dust cover

For protection from dust and light. Suitable for all KERN analytical balances, except KERN ADB, AET 100-5AM, AET 200-5DAM.

KERN ABS-A08, € 30,-



Thermal statistics printer

For printing weights, recipes etc. or for GLP record keeping of weighing data with date and time print. With extensive statistical functions for the analysis of measurements series. Suitable for all KERN analytical balances (except AET).

KERN YKS-01, € 390,-

Universal density set

Universal density set for precise and convenient density determination of liquids and solids \leq/\geq 1. Suitable for all KERN analytical balances.

KERN YDB-03, € 520,-



Moisture analysers

Moisture analysing is an integral part of production and processing of many raw and finished products and has a crucial impact on the quality of the product.

Moisture analysers are used particularly in the food industry, water resource management (sewage plants, etc.), plastics industry, agriculture and the energy industry (bio-energy plants, etc.).

Determining moisture requires a great deal of experience. Depending on the type of sample and the task involved, various drying processes are used.

KERN has concentrated on the most widely-used drying method: halogen drying, which brings many advantages:

- Sample is evenly warmed from above, without risk of burning the sample surface
- Affordable purchase costs ensure rapid amortisation of the device
- Most common temperature ranges from 35 – 200 °C

- High measuring precision, up to 0.01 %
- Sufficient buffer capacity, weighing range up to 160 g
- Various drying programs (soft drying, standard drying, drying in levels, rapid drying (Boost))





The numerous memories of the KERN moisture analyser are particularly useful, as they hold information on the complete drying processes with drying parameters such as drying time, drying period, drying temperature, display settings, switch off criteria, etc. This saves an enormous amount of time and helps to achieve repeatable results.

On the internet, you will find a practical application hand-book containing many examples, field reports, settings and tips for each KERN moisture analyser.

Note: We would be pleased to carry out individual analyses on the sample you submit, which will help you when setting the parameters of your moisture analyser and will lead to results which can be reproduced.

KERN 965-243, € 95,-/hour

Quick-Finder Moisture analysers

Read-out	Weighing range	Model	Price excl. of VAT ex works €	Page	 DAYS ready for shipping	 CAL EXT	 MEMORY	 RS 232
[d]	[Max]	KERN				For an explanation on the pictos, see the front flap		
0,001 g	50 g	MLS 50-3D	1450,-	57	1	●	○	○
0,001 g	60 g	DBS 60-3	1270,-	55	1	●	○	○
0,001 g	110 g	DAB 100-3	1130,-	54	1	●	○	○
0,001 g	160 g	DLB 160-3A	1170,-	56	1	●	○	○
0,001 g	160 g	DLT 100-3N	1870,-	58	1	●	○	○

■ = News 2016

● = Standard

○ = Option

Your product specialist's recommendation:



Optimum ease of operation



High level of process reliability thanks to drying programs which can be stored



Graphics display aids when setting and monitoring the drying process



Jesús Martínez

Product specialist Moisture analysers

Tel. +49 [0] 7433 9933-209

Fax +49 [0] 7433 9933-29209

jesus.martinez@kern-sohn.com



only €
1130,-
▶ page 54

KERN DAB

NEW

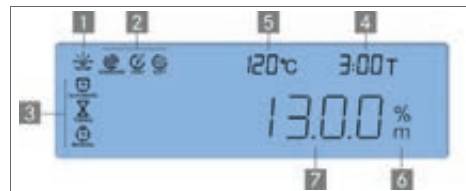

04

Moisture analyser with user-friendly graphics display and 15 memories for drying programs

Features

- Backlit LCD display, digit height 14 mm
- 1 Drying process active
- 2 Active heating profile
- 3 Active switch-off criteria
- 4 Previous drying time
- 5 Current temperature
- 6 Moisture display in %
- 7 Interim result in moisture-%
- Halogen quartz glass heater 400 W
- Observation window above the sample, useful during initial setting
- Internal memory for automatic sequence of 15 complete drying processes and 5 drying processes carried out
- The last value measured remains on the display until it is replaced by a new measurement
- 50 sample plates included
- Application handbook: On the internet, you will find a practical application handbook containing many examples, field reports, settings and tips for each KERN moisture analyser

STANDARD



OPTION



KERN	DAB 100-3
Readout [d]	0,001 g 0,01 %
Weighing range [Max]	110 g
Reproducibility, weight of sample 10 g	0,02 %
Display after drying (Display can be switched over at any time)	
Moisture [%] = Moisture content (M) from wet weight (W)	0-100 %
Dry content [%] = Dry weight (D) from W	100-0 %
Moisture content (M)	Absolute value in [g]
Temperature range	35 °C - 160 °C in steps up to 1 °C
Drying modes	<input type="checkbox"/> Standard drying <input checked="" type="checkbox"/> Gentle drying <input checked="" type="checkbox"/> Rapid drying
Switch off criteria	<ul style="list-style-type: none"> • Automatic switch off (2 mg loss in weight in 45 s) • Time controlled switch off (3 min - 99 h 59 min, 10 s increments) • Manual switch off at the press of a button
Recall of measurement	<ul style="list-style-type: none"> • At the end of the drying process, manual or automatic (Only in connection with KERN YKC-01)
Overall dimensions WxDxH	240x365x180 mm
Net weight	4,82 kg
Price €, excl. of VAT, ex works	1130,-
Option DAKKS Calibr. Certificate	963-127, € 72,-

Accessories

- Sample plates aluminium, Ø 90 mm. Unit of 80 pieces, KERN MLB-A01A, € 45,-
- Round fiberglass filter e.g. for samples that splash or become encrusted. Box with 100 pieces, KERN RH-A02, € 80,-
- 8 Temperature calibration set consists of measuring sensor and display device, KERN DAB-A01, € 190,-
- RS-232/Ethernet adapter for connection to an IP-based Ethernet network, KERN YKI-01, € 390,-
- RS-232/Bluetooth adapter to connect to Bluetooth capable devices, such as Bluetooth printers, tablets, laptops, smartphones, etc., KERN YKI-02, € 260,-
- RS-232/WiFi adapter for wireless connection to networks and WLAN capable devices, such as tablets, laptops or smartphones, KERN YKI-03, € 780,-
- Thermal printer, KERN YKB-01N, € 325,-

Moisture analyser KERN DBS

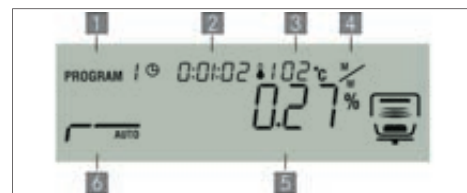

04

Moisture analyser with graphics display and 10 memories for drying programs

STANDARD



OPTION

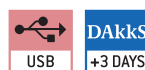

KERN	DBS 60-3
Readout [d]	0,001 g / 0,01 %
Weighing range [Max]	60 g
Reproducibility weight of sample 2 g	0,15 %
Reproducibility, weight of sample 10 g	0,02 %
Display after drying (Display can be switched over at any time)	
Moisture [%] = Moisture content (M) from wet weight (W)	0 - 100 %
Dry content [%] = Dry weight (D) from (W)	100 - 0 %
ATRO [%] [(W-D) : D] · 100%	0 - 999 %
Moisture content [g] (M)	Absolute value in [g]
Temperature range	50 - 200 °C in steps up to 1 °C
Drying modes	<ul style="list-style-type: none"> <input type="checkbox"/> Standard drying <input type="checkbox"/> Drying in levels <input type="checkbox"/> Gentle drying <input type="checkbox"/> Rapid drying
Switch off criteria	<ul style="list-style-type: none"> • Automatic unrestricted switch off (Selectable loss in weight 0,01%-0,1% in 30 s) <ul style="list-style-type: none"> • Time controlled switch off (1 min - 12 h) • Manual switch off at the press of a button
Recall of measurement	Interval can be set from 1 sec - 10 min (Only when used with printer KERN YKB-01 or PC)
Overall dimensions WxDxH	202x336x157 mm
Net weight	approx. 4,2 kg
Price €, excl. of VAT, ex works	1270,-
Option DAkKS Calibr. Certificate	963-127, € 72,-

Features

- Backlit LCD display, digit height 15 mm
- 1 Drying program
- 2 Previous drying time
- 3 Current temperature
- 4 Unit of the shown result, e.g. moisture
- 5 Current moisture content in %
- 6 Drying mode/Status display drying
- **Halogen quartz glass heater** 400 W
- **Observation window above the sample**, useful during initial setting
- **Internal memory** for automatic run of 10 drying programs and 100 drying processes already executed
- The last value measured remains on the display until it is replaced by a new measurement
- **Sample description** for up to 99 samples, 2 digits, freely programmable, and is printed in the measuring protocol
- **Date and time display** as standard
- **10 sample plates included**
- **Application handbook:** On the internet, you will find a practical application handbook containing many examples, field reports, settings and tips for each KERN moisture analyser

Accessories

- **Sample plates aluminium**, Ø 90 mm. Unit of 80 pieces, KERN MLB-A01A, € 45,-
- **Round fiberglass filter** e.g. for samples that splash or become encrusted. Box with 100 pieces, KERN RH-A02, € 80,-
- **Temperature calibration set** consists of measuring sensor and display device, KERN DBS-A01, € 480,-
- **USB interface kit** for bi-directional data exchange between moisture analyser and computer. Scope of delivery: USB cable, driver, Software Balance Connection, KERN DBS-A02, € 290,-
- **Protective working cover** standard. Can be re-ordered, scope of delivery: 5 items, KERN DBS-A03S05, € 65,-
- **Thermal printer**, KERN YKB-01N, € 325,-



04

The moisture analyser for heavy, high-volume samples

STANDARD



OPTION



KERN	DLB 160-3A
Readout [d]	0,001 g / 0,01 %
Weighing range [Max]	160 g
Reproducibility, weight of sample 10 g	0,05 %
Display after drying (Display can be switched over at any time)	
Moisture [%] = Moisture content (M) from wet weight (W)	0 - 100 %
Dry content [%] = Dry weight (D) from (W)	100 - 0 %
ATRO [%] [(W-D) : D] · 100%	0 - 999 %
Moisture content (M)	Absolute value in [g]
Temperature range	35 °C - 160 °C in steps up to 1 °C
Drying modes	<input type="checkbox"/> Standard drying <input checked="" type="checkbox"/> Rapid drying, Pre-heat level, can be switched on
Switch off criteria	<ul style="list-style-type: none"> • Automatic unrestricted switch off (Selectable loss in weight 0,1%-9,9% in 60 s) <ul style="list-style-type: none"> • Time controlled switch off (1 min - 99 min) • Manual switch off at the press of a button
Recall of measurement	<ul style="list-style-type: none"> • Continuous output (residual weight) • At the end of the drying process, manual or automatic (Only in connection with KERN YKB-01N printer or PC)
Overall dimensions WxDxH	210x340x225 mm
Netweight	approx. 4,2 kg
Price €, excl. of VAT, ex works	1200,-
Option DAKKS Calibr. Certificate	963-127, € 72,-

Features

- Backlit LCD display, digit height 17 mm
 - 1 Current moisture content in %
 - 2 Unit of the shown result, e.g. % moisture
 - 3 Drying process active
- **Halogen quartz glass heater** 400 W
- **Internal memory** for automatic sequence of 5 complete drying processes
- The last value measured remains on the display until it is replaced by a new measurement
- **10 sample plates included**
- **Application handbook:** On the internet, you will find a practical application handbook containing many examples, field reports, settings and tips for each KERN moisture analyser

Accessories

- **Sample plates aluminium**, Ø 90 mm. Box with 80 pieces, KERN MLB-A01A, € 45,-
- **Round fibreglass filter** e.g. for samples that splash or become encrusted. Box with 100 pieces, KERN RH-A02, € 80,-
- **5 Temperature calibration set** consists of measuring sensor and display device, KERN DLB-A01, € 290,-
- **Protective working cover** standard. Can be re-ordered, scope of delivery: 5 items, KERN ALJ-A01S05, € 40,-
- **Suitable printers** see page 177 ff.

NEW

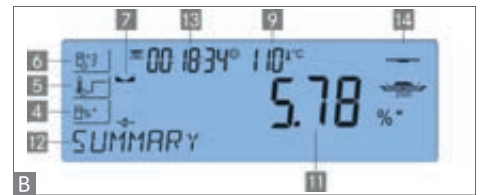
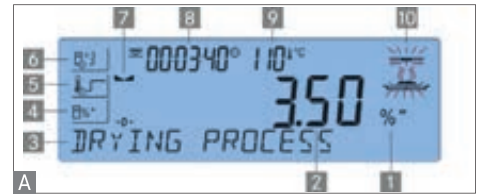

04

Infrared moisture analyzer with graphics display and a vast database

STANDARD

- CAL EXT
- MEMORY
- RS 232
- GLP
- INTERN
- UNIT
- 230 V
- FORCE
- 1 DAY
- 3 YEARS WARRANTY

OPTION

- DAkKS
- +3 DAYS

KERN	MLS 50-3D
Readout [d]	0,001 g / 0,01 %
Weighing range [Max]	50 g
Reproducibility, weight of sample 2 g	0,1 %
Reproducibility, weight of sample 10 g	0,02 %
Display after drying (Display can be switched over at any time)	
Moisture [%] = Moisture content (M) from wet weight (W)	0 - 100 %
Dry content [%] = Dry weight (D) from (W)	100 - 0 %
ATRO [%] [(W-D):D] · 100%	0 - 999 %
Moisture content (M)	Absolute value in [g]
Temperature range	40 °C - 160 °C in steps up to 1 °C
Drying modes	<input type="checkbox"/> Standard drying <input type="checkbox"/> Drying in levels <input type="checkbox"/> Gentle drying <input type="checkbox"/> Rapid drying
Switch off criteria	<ul style="list-style-type: none"> • Automatic switch off (AUTO 1 - 5) • Automatic unrestricted switch off (selectable 1-10 mg / 10-120 s) • Time controlled switch off (1 min - 99 h 59 min) • Manual switch off at the press of a button
Recall of measurement	Interval can be set from 1 sec - 10 min (Only when used with printer KERN YKB-01N or PC)
Overall dimensions WxDxH	206x333x192 mm
Net weight	approx. 4,9 kg
Price €, excl. of VAT, ex works	1450,-
Option DAkKS Calibr. Certificate	963-127, € 72,-

Features

- Backlit graphic display, digit height 14mm
- A Display during the drying process:**
 - 1 Moisture display in %
 - 2 Interim result in moisture-%
 - 3 Drying process active
 - 4 Active result display
 - 5 Active heating profile
 - 6 Active switch-off criteria
 - 7 Stability display
 - 8 Previous drying time
 - 9 Current temperature
 - 10 Drying process active
- B Display after the drying process:**
 - 11 End result in moisture-%
 - 13 Active result display
 - 14 Drying process has finished
- **Infrared heater** 400 W
- **Observation window above the sample**, useful during initial setting
- **Balance contains memory** for automatic sequence of 100 complete drying programs (92 drying programs with optimised drying characteristics for rapid sample warming and therefore shorter drying times, pre-installed at the factory), 100 users with related authorisations, 1000 drying processes performed and 1000 weighing results (alibi memory)
- The last value measured remains on the display until it is replaced by a new measurement
- The large ventilation slots in the heating cover combined with the sample viewing window in the form of a metal grid, ensure that moisture exhausts quickly which leads to shorter drying times
- **10 sample plates included**
- **Application handbook:** There are many practical examples in the user manual

Accessories

- **Sample plates aluminium**, Ø 90 mm. Unit of 80 pieces, KERN MLB-A01A, € 45,-
- **Round fiberglass filter** e.g. for samples that splash or become encrusted. Box with 100 pieces, KERN RH-A02, € 80,-
- **Temperature calibration set** consists of measuring sensor and display device, KERN MLB-A12, € 590,-
- **Protective working cover** standard. Can be re-ordered, scope of delivery: 5 items, KERN ALS-A02S05, € 35,-
- **Thermal printer**, KERN YKB-01N, € 325,-



04



High-end moisture analyser with touch-sensitive tablet and innovative Android® operating system



Particularly in the pharmaceutical, food, chemical and construction industries, being able to analyse the moisture content of materials at Goods Inwards and production is an important tool to ensure product quality and robust production processes.



In biogas plants, sewage treatment plants or landfill sites, the drying of biomass has always been extremely important. Controlling the moisture content precisely helps, for example, to reduce transport weights or increase heating values



In the timber industry, statements which can be validated relating to the moisture content and the resulting mechanical and technological characteristics of the wood or the fuel and heating values of wood chips, pellets, etc. are of economic importance

Moisture analyser KERN DLT-N



Features

Innovative touchscreen:

Large touch-sensitive, backlit screen with very good contrast for easy operation and convenient reading

Clear menu structure with plain text labels on the display. The menu and processes are self-explanatory. This reduces the training times, avoids operating errors and in this way, ensures more efficient functionality

Tablet: Colour LCD Display, digit height 12 mm, screen diagonal 7" (approx. 178 mm), WxH 118x88 mm, table stand standard, all information at a glance:

- 1 Drying process active
- 2 Status information, available for display
- 3 Current moisture content in %
- 4 Current temperature
- 5 Android®-specific navigation elements
- 6 Drying rate
- 7 Switch off mode
- 8 Drying type *Standard*
- 9 Target temperature
- 10 Current display and print-out of moisture-%

12 Practical net weighing assistance to a defined target value [g] with adjustable tolerance range 1 – 25 % of the target value

11 Graphic display of the drying curve shows the progress of the drying process in real time and can be used by the operator to check and evaluate the result

- **High mobility thanks to tablet operation**, data is available any time, anywhere
- **High-performance Android® operating system**
- **Lots of memory** for your applications
- **Halogen quartz glass heater** 400 W
- **10 sample plates included**
- **WLAN and Bluetooth interfaces as standard** to transfer data to a PC (e.g. to KERN Balance-Connection 4.0 software, see page 179) or to print out the weighing data, drying curves etc. for archiving purposes using a Bluetooth thermal printer KERN YKC-01, see page 178

13 Balance contains memories for 100 memories for drying processes (drying protocols) which have been carried out and which can be recalled individually



Balance contains memories for automatic sequence of 300 drying programs (12 free characters for each memory). Many useful programs are already preinstalled

STANDARD



OPTION

KERN	DLT 100-3N
Readout [d]	0,001 g 0,01 %
Weighing range [Max]	160 g
Reproducibility, weight of sample 10 g	0,001 g
Display after drying (Display switchable at all times)	
Moisture [%] = Moisture content (M) from wet weight	0–100 %
Dry content [%] = Dry weight (D) from (W)	100–0 %
ATRO [%] [(W-D):D] · 100%	0–999 %
Residual weight (M)	Absolute value in [g]
Temperature range	35 °C–160 °C in steps of 1 °C
Drying modes	<input type="checkbox"/> Standard drying <input type="checkbox"/> Gradual drying <input type="checkbox"/> Gentle drying <input type="checkbox"/> Rapid drying
Switch off criteria	<ul style="list-style-type: none"> • Automatic unrestricted switch off (selectable loss in weight 0,1–10 % or 1–60 mg, selectable time 1–99 s) <ul style="list-style-type: none"> • Time controlled switch off (1 min–99 min) • Manual switch off at the press of a button
Log output	<ul style="list-style-type: none"> • At the end of the drying process, manual or automatic (only in connection with printer KERN YKC-01)
Dimensions Moisture analyser WxDxH	210x340x225 mm
Dimensions Tablet WxDxH	195x120x10 mm
Net weight	5,2 kg
Price €, excl. of VAT ex works	1870,-
Option DAKKS Calibration Certificate	963-127, € 72,-

Price reduction

For more information, please visit kern-sohn.com/en/DLT-N · Order hotline +49 [0] 7433 9933-0

Accessories

- **Sample plates aluminium**, Ø 90 mm. Unit of 80 pieces, KERN MLB-A01A, € 45,-
- **Round fiberglass filter** e.g. for samples that splash or become encrusted. Unit of 100 pieces, KERN RH-A02, € 80,-
- **Temperature calibration set**, KERN DLB-A01N, € 460,-
- **Protective working cover** standard, can be reordered, scope of delivery: 5 items, KERN ALJ-A01S05, € 40,-
- **Bluetooth thermal printer**, suitable for wireless connection to compatible, Bluetooth-enabled moisture analysers, balances, dynamometers etc., KERN YKC-01, € 690,-



Compact industrial weighing technology

Thanks to their compact dimensions, low weight, robust internal mechanism and the fact that they can be operated independent of mains power, bench scales can be used not only in a stationary situation, but also as mobile scales.

With weighing ranges between 3 kg and 65 kg, bench scales can cover a wide range of applications. Whether as a commissioning scale in the warehouse, for inventory purposes, on a production work station, in quality control, in small workshops, in service cars or in sales offices, bench scales are the first choice.

Durable stainless steel weighing plates, easy to read backlit displays, useful functions such as piece counting, PRE-TARE – subtraction of a known container weight, or → **interfaces** to PC and printer, all these support the user in their daily work

→ **Dual range** scales cover a particularly wide range of applications. With these scales, the total weighing range is divided into 2 subranges and begins with a high resolution read-out in the fine weighing range. If this range is exceeded the balance automatically switches to the higher weighing range with the lower resolution read-out.

All KERN bench scales have an adjustment program (CAL) to adjust the accuracy. In this way, the high level of accuracy is guaranteed at all times, even during harsh everyday use. Find the right test weights for you, see page 188.

Touchscreen balances

The newest development for an even greater level of user-friendliness is the intuitive touchscreen operation, which is being integrated into new KERN models, see page 34/35 (PKT), 41–43 (PET), 50/51 (AET), 70/71 (FKT), 170/171 (FKTF), 96 (FKA), 97 (FKC), 118/119 (IKT), 120/121 (ILT)

→ See the glossary on page 214 – 216

Your product specialist's recommendation:

With type approval – which makes it suitable for a wide variety of uses, e.g. retail, catering trade, supermarkets, cafeterias, etc.



Designed for mobile use



Rapid and steady weighing results



Edeltraud Semma-Hauser
Product specialist Bench scales

Tel. +49 [0] 7433 9933-140
Fax +49 [0] 7433 9933-29140
semma-hauser@kern-sohn.com













KERN GAB-N

from €

230,-

▶ page 67

Quick-Finder Bench scales

Read-out [d]	Weighing range [Max]	Model KERN	Price excl. of VAT ex works €	Page	 DAYS ready for shipping	         For an explanation on the pictos, see the front flap									
						●	●	●	●	●	●	●	●	●	●
0,05 g	6 kg	GAB 6K0.05N	300,-	67	1		●			●	●				○
0,02 g	6 kg	FKB 6K0.02	510,-	69	1		●			●	●			○	●
0,05 g	6 kg	GAB 6K-5P	600,-	68	1		●			●	●				●
0,02 g	6 kg	FKT 6K0.02L	890,-	70	1		●	●	●	●	●			○	○
0,05 g	8 kg	FKB 8K0.05	460,-	69	1		●			●	●			○	○
0,05 g	16 kg	FKB 16K0.05	560,-	69	1		●			●	●			○	○
0,05 g	16 kg	FKT 16K0.05L	890,-	70	1		●	●	●	●	●			○	○
0,1 g	3 kg	FCB 3K0.1	220,-	65	1		●			●	●			○	○
0,1 g	6 kg	FKT 6K0.1	790,-	70	1		●	●	●	●	●			○	○
0,1 g	8 kg	FCB 8K0.1	240,-	65	1		●			●	●			○	○
0,1 g	8 kg	FKB 8K0.1A	300,-	66	1		●			●	●			○	○
0,1 g	8 kg	FKB 8K0.1M	540,-	69	1	○	●			●	●			○	○
0,1 g	12 kg	GAB 12K0.1N	300,-	67	1		●			●	●				○
0,1 g	12 kg	GAB 10K-4P	590,-	68	1		●			●	●				●
0,1 g	16 kg	FKB 16K0.1	460,-	69	1		●			●	●			○	○
0,1 g	36 kg	FKB 36K0.1	520,-	69	1		●			●	●			○	○
0,1 g	36 kg	FKT 36K0.1L	890,-	70	1		●	●	●	●	●			○	○
0,2 g	12 kg	FKT 12K0.2	790,-	70	1		●	●	●	●	●			○	○
0,2 g	30 kg	GAB 30K0.2N	300,-	67	1		●			●	●				○
0,2 g	30 kg	GAB 30K-4P	590,-	68	1		●			●	●				●
0,2 g	36 kg	FKB 36K0.2	480,-	69	1		●			●	●			○	○
0,2 g	65 kg	FKB 65K0.2	520,-	69	1		●			●	●			○	○
0,2 g	65 kg	FKT 65K0.2L	890,-	70	1		●	●	●	●	●			○	○
0,5 g	6 kg	FCB 6K0.5	195,-	65	1		●			●	●			○	○
0,5 g	15 kg	FKB 15K0.5A	290,-	66	1		●			●	●			○	○
0,5 g	30 kg	FKT 30K0.5L	790,-	70	1		●	●	●	●	●			○	○
0,5 g	65 kg	FKB 65K0.5	480,-	69	1		●			●	●			○	○
1 g	3 kg	FCE 3K1N	110,-	64	1		●			●	●			○	○
1 g	6 kg	FKT 6K1LM	890,-	70	1	○	●	●	●	●	●			○	○
1 g	12 kg	FCB 12K1	185,-	65	1		●			●	●			○	○
1 g	15 kg	FKB 15K1A	260,-	66	1		●			●	●			○	○
1 g	30 kg	FCB 30K1	220,-	65	1		●			●	●			○	○
1 g	30 kg	FKB 30K1A	290,-	66	1		●			●	●			○	○
1 g	60 kg	FKT 60K1L	790,-	70	1		●	●	●	●	●			○	○
1 g	65 kg	FKB 65K1A	300,-	66	1		●			●	●			○	○
1 g	65 kg	FKB 65K1M	550,-	69	1	○	●			●	●			○	○
1 2 g	3 6 kg	GAB 6K1DNM	230,-	67	1	○	●			●	●				○
1 2 g	3 6 kg	GAB 6K-3PM	510,-	68	1	○	●			●	●				●
2 g	6 kg	FCE 6K2N	110,-	64	1		●			●	●			○	○
2 g	12 kg	FKT 12K2LM	890,-	70	1	○	●	●	●	●	●			○	○
2 g	24 kg	FCB 24K2	185,-	65	1		●			●	●			○	○
2 5 g	6 15 kg	GAB 15K2DNM	230,-	67	1	○	●			●	●				○
2 5 g	6 15 kg	GAB 10K-3PM	510,-	68	1	○	●			●	●				●
5 g	10 kg	ECE 10K-3N	99,-	62	1		●			●	●			○	○
5 g	10 kg	ECB 10K-3N	120,-	62	1		●			●	●			○	○
5 g	15 kg	FCE 15K5N	110,-	64	1		●			●	●			○	○
5 g	30 kg	FKT 30K5LM	890,-	70	1	○	●	●	●	●	●			○	○
5 10 g	15 30 kg	GAB 30K5DNM	230,-	67	1	○	●			●	●				○
5 10 g	15 30 kg	GAB 30K-3PM	510,-	68	1	○	●			●	●				●
10 g	20 kg	ECE 20K-2N	99,-	62	1		●			●	●			○	○
10 g	20 kg	ECB 20K-2N	120,-	62	1		●			●	●			○	○
10 g	30 kg	FCE 30K10N	110,-	64	1		●			●	●			○	○
10 g	60 kg	FKT 60K10LM	890,-	70	1	○	●	●	●	●	●			○	○
20 g	50 kg	ECE 50K-2N	99,-	62	1		●			●	●			○	○
20 g	50 kg	ECB 50K-2N	120,-	62	1		●			●	●			○	○

■ = News 2016

● = Standard

○ = Option

NEW



Plain, mobile, uncomplicated

Features

- **High mobility:** Battery operation, compact, flat construction, recessed grips on the underside and low weight make this balance ideal for use in several locations
- **Particularly large weighing plate**
- **Very fast display:** steady weight values within 2 sec
- **Simple and convenient 2-key operation**

Technical data

- Large backlit LCD display, digit height 21 mm
- Weighing plate dimensions (1 ECE: plastic, ECB: stainless steel) WxD 318x258 mm
- Overall dimensions WxDxH 320x300x60 mm
- Optional battery operation, 6 x 1.5 V AA not included, operating time up to 100 h. AUTO-OFF function to preserve the batteries
- Permissible ambient temperature 5 °C / 35 °C

Accessories

- **External universal mains adapter**, with universal input and optional input socket adapters for CH, EU, GB, USA, not included, can be retrofitted, KERN YKA-03, € 40,-
- **Rechargeable battery pack internal**, operating time up to 30 h, charging time approx. 10 h. AUTO-OFF function to preserve the battery, can be retrofitted, KERN PCB-A01, € 70,-
- **Rechargeable battery pack external**, operating time up to 270 h, charging time approx. 10 h, can be retrofitted, KERN KS-A01, € 180,-
- **Tare pan made of stainless steel**, ideal for weighing loose small parts, fruit, vegetables etc., WxDxH 370x240x20 mm, for details see page 182, KERN RFS-A02, € 55,-
- **Suitable test weights**, also with calibration certificate see page 188

STANDARD



OPTION



Model	Weighing range [Max] kg	Readout [d] g	Reproducibility g	Linearity g	Net weight approx. kg	Price excl. of VAT ex works €	Option DAkkS Calibr. Certificate	
							DKD KERN	€
KERN								
ECE 10K-3N	10	5	5	± 20	1,5	99,-	963-128	88,-
ECE 20K-2N	20	10	10	± 40	1,5	99,-	963-128	88,-
ECE 50K-2N	50	20	20	± 80	1,5	99,-	963-128	88,-
ECB								
ECB 10K-3N	10	5	5	± 20	2,5	120,-	963-128	88,-
ECB 20K-2N	20	10	10	± 40	2,5	120,-	963-128	88,-
ECB 50K-2N	50	20	20	± 80	2,5	120,-	963-128	88,-



“ Here at KERN we know the high demands you make on your bench scales in the various fields of trade, commerce and production. We have therefore developed multi-talented products which will help to make your tasks easier to handle each day and meet your requirements for accuracy and quality.

”

*Martin Goltz and Michael Stark,
KERN Product management*



Entry-level bench scale – mobile, practical, lightweight

Features

- **Simple and convenient 2-key operation**
- **Very fast display:** steady weight values within 2 sec
- **1** Ideal as a compact letter and parcel scale, especially where space is limited
- **2** Ideal as a grading, commissioning or simple checkweighing scale in production or dispatch

Technical data

- Large LCD display, digit height 25 mm
- Weighing plate dimensions, plastic, WxD 252x228 mm
- Overall dimensions WxDxH 270x345x106 mm
- Optional battery operation, 9 V block not included, operating time up to 12 h. AUTO-OFF function to preserve the battery.
- Net weight approx. 2,5 kg
- Permissible ambient temperature 5 °C / 35 °C

Accessories

- **Protective working cover** over keyboard and housing, standard. Can be re-ordered, scope of delivery: 5 items, KERN FCB-A02S05, **€ 35,-**
- **B** **Stainless steel weighing plate**, robust, removable, for easy cleaning, KERN FCE-A01, **€ 35,-**
- **Rechargeable battery pack internal**, AUTO-OFF function to preserve the battery, can be switched off, operating time up to 20 h, charging time approx. 10 h, can be retrofitted, KERN FCB-A01, **€ 50,-**
- **Suitable test weights**, also with calibration certificate see page 188

STANDARD



OPTION



Model	Weighing range [Max] kg	Readout [d] g	Reproducibility g	Linearity g	Price excl. of VAT ex works €	Option DAkkS Calibr. Certificate	
						DKD KERN	€
FCE 3K1N	3	1	2	± 3	110,-	963-127	72,-
FCE 6K2N	6	2	2	± 4	110,-	963-128	88,-
FCE 15K5N	15	5	10	± 15	110,-	963-128	88,-
FCE 30K10N	30	10	10	± 30	110,-	963-128	88,-



Bench scale with second display on the backside of the scale

Features

- **Second display** on the rear of the balance
- **PRE-TARE function** for manual subtraction of a known container weight, useful for checking fill-levels
- **High mobility:** Battery operation/ rechargeable battery pack (optional), compact construction and low weight make this balance ideal for use in several locations (production, warehouse, dispatch department etc.)

Technical data

- Backlit LCD display, digit height 25 mm
- Weighing plate dimensions, stainless steel, WxD 252x228 mm
- Overall dimensions WxDxH 270x345x106 mm
- Optional battery operation, battery 9 V block not standard, operating time up to 12 h
- Net weight approx. 3 kg
- Permissible ambient temperature 5 °C / 35 °C

Accessories

- **Protective working cover** over keyboard and housing, standard. Can be re-ordered, scope of delivery: 5 items, KERN FCB-A02S05, **€ 30,-**
- **Rechargeable battery pack internal**, operating time up to 10 h without backlight, charging time approx. 10 h, can be retrofitted, KERN FCB-A01, **€ 50,-**
- **Suitable test weights**, also with calibration certificate see page 188
- **Suitable printers** see page 177 ff.

STANDARD



OPTION



Model	Weighing range [Max] kg	Readout [d] g	Reproducibility g	Linearity g	Min. piece weight [Counting] g/piece	Price excl. of VAT ex works €	Option DAkkS Calibr. Certificate	
							DKD KERN	€
FCB 3K0.1	3	0,1	0,1	± 0,3	0,2	220,-	963-127	72,-
FCB 8K0.1	8	0,1	0,1	± 0,3	0,2	240,-	963-128	88,-
FCB 6K0.5	6	0,5	0,5	± 1,5	1	195,-	963-128	88,-
FCB 12K1	12	1	1	± 3	2	185,-	963-128	88,-
FCB 30K1	30	1	1	± 3	2	220,-	963-128	88,-
FCB 24K2	24	2	2	± 6	4	185,-	963-128	88,-



Bench scale up to 65 kg with large weighing plate

Features

- **PRE-TARE function** for manual subtraction of a known container weight, useful for checking fill-levels
- **Particularly practical:** thanks to the large weighing ranges and compact dimensions, you can accurately weigh heavy loads in the most restricted of spaces. Useful for determining very small weight differences, such as, for example, gas wastage, abrasion of mechanical parts etc.
- **Freely programmable weighing unit**, e.g. display direct in special units such as length of wire g/m, surface weight g/m², or else

Technical data

- Large backlit LCD display, digit height 25 mm
- Weighing plate dimensions, stainless steel, WxD 340x240 mm
- Overall dimensions WxDxH 350x390x120 mm
- Optional battery operation, 9 V block not included, operating time up to 12 h
- Net weight approx. 6,5 kg
- Permissible ambient temperature 5 °C / 35 °C

Accessories

- **Protective working cover** over keyboard and housing standard. Can be re-ordered, scope of delivery: 5 items, KERN FKB-A02S05, € 30,-
- **Rechargeable battery pack internal**, operating time up to 8 h, charging time approx. 10 h can be retrofitted, KERN PCB-A01, € 70,-
- **Suitable test weights**, also with calibration certificate see page 188
- **Suitable printers** and further, extensive accessories from page 177 ff.

STANDARD



OPTION



Model	Weighing range [Max] kg	Readout [d] g	Reproducibility g	Linearity g	Min. piece weight [Counting] g/piece	Price excl. of VAT ex works €	Option DAkKS Calibr. Certificate	
							DKD KERN	€
FKB 8K0.1A	8	0,1	0,1	± 0,3	0,2	300,-	963-128	88,-
FKB 15K0.5A	15	0,5	0,5	± 1,5	1	290,-	963-128	88,-
FKB 15K1A	15	1	1	± 2	2	260,-	963-128	88,-
FKB 30K1A	30	1	1	± 3	2	290,-	963-128	88,-
FKB 65K1A	65	1	1	± 3	2	300,-	963-129	105,-

Bench scale KERN GAB-N



Application examples:

- Small industrial scale for pharmacies
- Hand mixtures of tea, coffee, chocolates
- Portioning of dough, meat, fish, poultry, mixed salads in cafeterias etc.
- Mobile weighing of freshly picked fruit on site
- High-precision industrial applications

Note: Official verification duty for commercial trade

Checkweighing and portioning scale, also with EC type approval [M]

Features

- **Compact size**, practical for small spaces
- **High mobility:** thanks to battery operation (optional)
- **Weighing with tolerance range (checkweighing):** Input of an upper/lower limit value. A visual and audible signal assists with portioning, dispensing or grading
- **Totalising** of weights

Technical data

- Large backlit LCD display, digit height 24 mm
- Weighing plate dimensions, stainless steel, WxD 294x225 mm
- Overall dimensions WxDxH 320x330x125 mm
- Net weight approx. 3 kg
- Permissible ambient temperature 0 °C / 40 °C

Accessories

- **Protective working cover**, scope of delivery: 5 items, KERN CFS-A02S05, € 40,-
- **Signal lamp** for visual support of weighing with tolerance range, for details see page 181, KERN CFS-A03, € 250,-

- **Rechargeable battery pack internal**, operating time up to 90 h without backlight, charging time approx. 12 h, can be retrofitted, KERN GAB-A04, € 40,-
- **Y-cable** for parallel connection of two terminal devices to the RS-232 interface on the scale, e.g. signal lamp and printer, KERN CFS-A04, € 35,-
- **Suitable test weights**, also with calibration certificate see page 188
- **Suitable printers** and further, extensive accessories from page 177 ff.

STANDARD



OPTION



FACTORY



Model	Weighing range [Max] kg	Readout [d] g	Verification value [e] g	Minimum load [Min] g	Min. piece weight [Counting] g/piece	Price excl. of VAT ex works €	Options			
							Verification		DAkkS Calibr. Certificate	
							M KERN	€	DKD KERN	€
GAB 6K0.05N	6	0,05	-	-	0,05	300,-	-	-	963-128	88,-
GAB 12K0.1N	12	0,1	-	-	0,1	300,-	-	-	963-128	88,-
GAB 30K0.2N	30	0,2	-	-	0,2	300,-	-	-	963-128	88,-
Note: For applications that require verification, please order verification at the same time, initial verification at a later date is not possible. Verification at the factory, we need to know the full address of the location of use.										
Dual-range balance switches automatically to the next largest weighing range [Max] and readout [d].										
GAB 6K1DNM	3 6	1 2	1 2	20	0,2	230,-	965-228	55,-	963-128	88,-
GAB 15K2DNM	6 15	2 5	2 5	40	0,5	230,-	965-228	55,-	963-128	88,-
GAB 30K5DNM	15 30	5 10	5 10	100	1	230,-	965-228	55,-	963-128	88,-



Application examples:

- Small industrial scale for pharmacies
- Hand mixtures of tea, coffee, chocolates
- Portioning of dough, meat, fish, poultry, mixed salads in cafeterias etc.
- pick your own fruit and vegetable sales
- High-precision industrial applications, piece counting or stock-taking

Note: Official verification duty for commercial trade

Checkweighing and portioning scale with integrated printer and EC type approval [M]

Features

- Precise bench scale for applications (which require verification), where the weight values must be documented and archived through print outs or data transfer, such as, e.g. quantities obtained in stocktaking
- The determined weight, quantity, totals, percentage etc. can be printed out with clearly date and time
- **Internal printer:** Robust high-speed thermal printer. Fast and easy change of paper rolls thanks to innovative paper compartment construction
- **High mobility:** thanks to battery operation, compact construction and low weight,

it is suitable for use in several locations (production, warehouse, dispatch department etc.)

- **Compact size,** practical for small spaces
- **Weighing with tolerance range (checkweighing):** Input of an upper/lower limit value. A visual and audible signal assists with portioning, dispensing or grading

Technical data

- Large backlit LCD display, digit height 20 mm
- Weighing plate dimensions, stainless steel, WxD 365x235 mm
- Overall dimensions WxDxH 371x366x131 mm
- Net weight approx. 4,4 kg
- Permissible ambient temperature -10 °C / 40 °C

Accessories

- **Thermal receipt rolls** (10 pieces), width 56 mm, Ø 51 mm, KERN RFS-A10, € 40,-
- **Signal lamp,** for details see page 181, KERN CFS-A03, € 250,-
- **Rechargeable battery pack internal,** standard, operating time up to 150 hours without backlight and use of printer, charging time approx. 12 h, can be retrofitted, KERN HFM-A01, € 50,-
- **Suitable printers** and further, extensive accessories from page 177 ff.

STANDARD



OPTION



FACTORY



Model	Weighing range [Max] kg	Readout [d] g	Verification value [e] g	Minimum load [Min] g	Min. piece weight [Counting] g/piece	Price excl. of VAT ex works €	Options			
							Verification		DAkkS Calibr. Certificate	
							M KERN	€	DKD KERN	€
GAB 6K-5P	6	0,05	-	-	0,05	600,-	-	-	963-128	88,-
GAB 10K-4P	12	0,1	-	-	0,1	590,-	-	-	963-128	88,-
GAB 30K-4P	30	0,2	-	-	0,2	590,-	-	-	963-128	88,-
Note: For applications that require verification, please order verification at the same time, initial verification at a later date is not possible. Verification at the factory, we need to know the full address of the location of use.										
Dual-range balance switches automatically to the next largest weighing range [Max] and readout [d].										
GAB 6K-3PM	3 6	1 2	1 2	20	20	510,-	965-228	55,-	963-128	88,-
GAB 10K-3PM	6 15	2 5	2 5	40	40	510,-	965-228	55,-	963-128	88,-
GAB 30K-3PM	15 30	5 10	5 10	100	100	510,-	965-228	55,-	963-128	88,-

ONLY WHILE STOCKS LAST



Large, high resolution bench scale, also with EC type approval [M]

Features

- Thanks to the high resolution of up to 360,000 points it is ideal for high-precision weighing in the industrial field. It is also available in a version with EC type approval class II for applications which require verification (FKB-M)
- **PRE-TARE function** for manual subtraction of a known container weight, useful for checking fill-levels
- only FKB: **Freely programmable weighing unit**, e.g. display direct in special units such as length of wire g/m, surface weight g/m², or else
- **Particularly practical:** thanks to the large weighing ranges and compact dimensions, you can accurately weigh heavy loads in

the most restricted of spaces. Useful for determining very small weight differences, such as, e.g. gas wastage, abrasion of mechanical parts, rock samples, minerals, druses, silver etc.

Technical data

- Backlit LCD display, digit height 18 mm
- Weighing plate dimensions, stainless steel, WxD 340x240 mm
- Dimensions housing WxDxH 350x390x120 mm
- Optional battery operation, batteries 6 x 1.5 V Size C not standard, operating time up to 40 h
- Net weight approx. 6,5 kg
- Permissible ambient temperature
KERN FKB: 10 °C / 40 °C
KERN FKB-M: 10 °C / 30 °C

Accessories

- **Protective working cover** over keyboard and housing, standard. Can be re-ordered, scope of delivery: 5 items, KERN FKB-A02S05, **€ 30,-**
- only FKB: **Rechargeable battery pack external**, operating time up to 25 hours with backlight, charging time approx. 10 h, KERN KS-A01, **€ 180,-**
- **Tare pan made of stainless steel**, ideal for weighing loose small parts, WxDxH 370x240x20 mm, for details see page 182, KERN RFS-A02, **€ 55,-**
- **Suitable printers** and further, extensive accessories from page 177 ff.

STANDARD



OPTION



FACTORY



Model	Weighing range [Max] kg	Readout [d] g	Verification value [e] g	Reproducibility g	Linearity g	Min. piece weight [Counting] g/piece	Price excl. of VAT ex works €	Options			
								Verification		DAkkS Calibr. Certificate	
								MII KERN	€	DKD KERN	€
KERN FKB 6K0.02	6	0,02	-	0,04	± 0,1	0,02	510,-	-	-	963-128	88,-
FKB 8K0.05	8	0,05	-	0,05	± 0,15	0,05	460,-	-	-	963-128	88,-
FKB 16K0.05	16	0,05	-	0,1	± 0,25	0,05	560,-	-	-	963-128	88,-
FKB 16K0.1	16	0,1	-	0,1	± 0,3	0,1	460,-	-	-	963-128	88,-
FKB 36K0.1	36	0,1	-	0,2	± 0,5	0,1	520,-	-	-	963-128	88,-
FKB 36K0.2	36	0,2	-	0,2	± 0,6	0,2	480,-	-	-	963-128	88,-
FKB 65K0.2	65	0,2	-	0,4	± 1	0,2	520,-	-	-	963-129	105,-
FKB 65K0.5	65	0,5	-	0,5	± 1,5	0,5	480,-	-	-	963-129	105,-

Note: For applications that require verification, please order verification at the same time, initial verification at a later date is not possible. Verification at the factory, we need to know the full address of the location of use.

FKB 8K0.1M	8	0,1	1	0,1	± 0,3	0,1	540,-	965-217	77,-	963-128	88,-
FKB 65K1M	65	1	10	1	± 2	1	550,-	965-218	110,-	963-129	105,-



Alibi memory

- Ring memory for up to 49,152 measuring results (744 measuring results per day!)
- Saved measuring results cannot be changed or cleared. If the maximum memory capacity is reached, then the oldest value will be overwritten
- In addition to the measuring result, the date, time, tare value, a sequential number and the serial number of the balance are also saved.
- Saved measuring results can be searched and recalled easily
- The alibi memory can also be used for applications which do not require verification
- Complies with WELMEC 2.5



Touchscreen industrial scale with enormous range of functions, also with EC type approval [M]

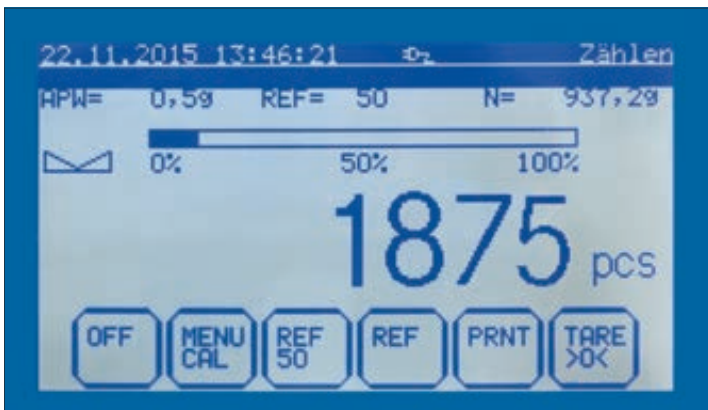

Display at full size, operating mode counting

Innovative touchscreen: Large touch-sensitive, backlit screen with very good contrast for easy operation and convenient reading

Advantages:

- The menu and processes are self-explanatory
- No more errors or lost time through keys which have several functions assigned to them or unclear markings
- Large keys, which can also be operated when wearing gloves
- More efficient, faster and safer working

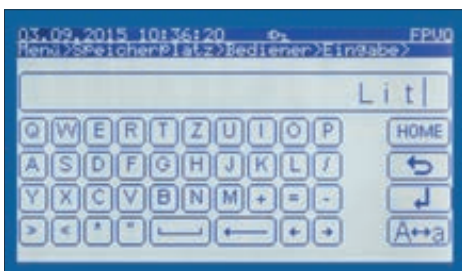

Easy entering of text and values

e.g. item descriptions, user name, weights of tare containers, etc. using the large keypad

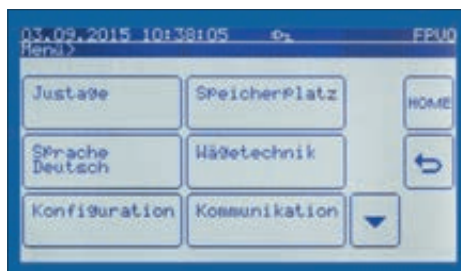

80 memories for each mode (FKT-M: 40)

e.g. for checkweighing, PRE-TARE, reference weight, target weight for dispensing etc.

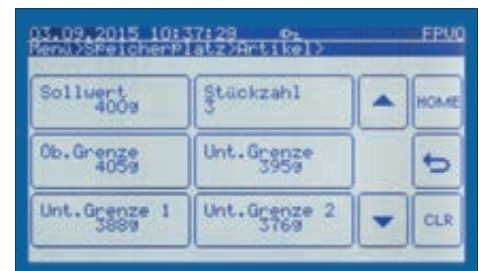

Weighing with tolerance range

(checkweighing): a visual and audible signal helps with portioning, dispensing or grading

Bench scale KERN FKT

Features

- **Convenient recipe weighing:** 99 recipes each with 10 components each can be stored in plain text. If one recipe ingredient is overweight, then the practical recipe adjustment function for when dosages are exceeded automatically calculates the new target weights of the other ingredients. The actual and target values and the proportionate percentage can then be printed. The recipes can be generated easily in an Excel list at the PC and transferred to the balance using the RS-232 interface. Alternatively, the recipes can also be entered directly using the keypad
- **Multiplier function:** recipes with the ingredient weights recorded as percentage values can easily be replicated by entering a new target weight. The ideal solution for the preparation of larger containers, bulk packs etc.
- **Rapid function** for shortened stabilisation time with reduced readout
- **16 print forms** which can store up to 20 different information, such as, e.g., date, time, operator, item, net, tare, gross, PCs, target weight, PRE-TARE etc. The print forms can be generated easily in an Excel list in the PC and transferred to the balance using the RS-232 interface
- **Control outputs (optocoupler, digital I/O)** to connect relays, signal lamps, valves etc. (35 V / 80 mA)
- **Hook for underfloor weighing** of hanging loads standard for models with weighing plate size **B**

Technical data

- Backlit LCD graphic display with digit height 18 mm, screen diagonal 5.8" (approx. 147 mm)
- Weighing plate dimensions (stainless steel) WxD
 - A** 253x228 mm
 - B** 340x240 mm, see enlarged picture
- Overall dimensions WxDxH
 - A** 270x345x106 mm
 - B** 350x390x120 mm
- Optional battery operation, only for models with weighing plate size **B**, 6 x 1.5 V Size C not included, operating time up to 20 h
- Permissible ambient temperature 10 °C / 40 °C

Accessories

- **Protective working cover** over keyboard and housing, standard. Can be re-ordered, scope of delivery: 5 items, for models with weighing plate size
 - A** KERN FCB-A02S05, € 30,-
 - B** KERN FKB-A02S05, € 30,-
- **Rechargeable battery pack external**, operating time up to 10 h, charging time approx. 10 h, not for FKT-M, KERN KS-A01, € 180,-
- **Signal lamp** for visual support of weighing with tolerance range, KERN IKT-A04, € 250,-
- **RS-232/Ethernet adapter**, for connection to an IP-based Ethernet network, for details see page 180, KERN YKI-01, € 390,-
- **RS-232/USB adapter** to connect peripheral devices with USB connection, for details, see page 181, KERN AFH 12, € 85,-
- **Suitable printers** and further, extensive accessories from page 177 ff.

Modes

- ① Weighing
- ② Counting
- ③ Dispensing
- ④ Recipe weighing
- ⑤ Checkweighing
- ⑥ Totalising with daily total
- ⑦ Percentage determination
- ⑧ Animal weighing
- ⑨ Surface weight
- ⑩ Density determination, only with **B**, not for **M**
- ⑪ Rapid function, not for **M**

Functions

- Capacity display, with ① - ②, ⑤ - ⑦, ⑨ - ⑪
- Dispensing aid (subtractive/additive), with ③, ④
- Net/gross display, permanent, with ①, ③ - ⑤, ⑧ - ⑩
- Variable reference quantity, with ②
- Automatic reference optimisation, with ②
- PRE-TARE numerical or from the memory unit, with ① - ⑦, ⑩
- Input of item or batch description, operator etc., with ① - ⑦, ⑩
- Freely programmable weighing unit, e.g. display direct in special units such as length of thread g/m, grammage g/m², or similar, with ⑨
- Date/time, with ① - ⑩
- Statistical function, with ①
- GLP printout, with ① - ⑩
- Individual formatting of up to 16 printer forms, recipes, operating mode master data in MS Excel, import via RS-232, for examples, see the internet, with ① - ⑩

05

STANDARD



OPTION

FACTORY



Model	Weighing range [Max] kg	Readout [d] g	Verific. value [e] g	Minimum load [Min] g	Reproducibility g	Linearity g	Min. piece weight [Counting] g/piece	Weighing plate	Price excl. of VAT ex works €	Options			
										Verification		DAKKS Calibr. Certificate	
										M KERN	€	DKD KERN	€
FKT 6K0.1	6	0,1	-	-	0,1	± 0,2	0,1	A	790,-	-	-	963-128	88,-
FKT 12K0.2	12	0,2	-	-	0,2	± 0,4	0,2	A	790,-	-	-	963-128	88,-
FKT 30K0.5L	30	0,5	-	-	0,5	± 1	0,5	B	790,-	-	-	963-128	88,-
FKT 60K1L	60	1	-	-	1	± 2	1	B	790,-	-	-	963-129	105,-
High-resolution display													
FKT 6K0.02L	6	0,02	-	-	0,04	± 0,1	0,02	B	890,-	-	-	963-128	88,-
FKT 16K0.05L	16	0,05	-	-	0,1	± 0,25	0,05	B	890,-	-	-	963-128	88,-
FKT 36K0.1L	36	0,1	-	-	0,2	± 0,5	0,1	B	890,-	-	-	963-128	88,-
FKT 65K0.2L	65	0,2	-	-	0,4	± 1	0,2	B	890,-	-	-	963-129	105,-
Note: For applications that require verification, please order verification at the same time, initial verification at a later date is not possible. Verification at the factory, we need to know the full address of the location of use.													
FKT 6K1LM	6	1	1	20	0,5	± 0,5	1	B	890,-	950-128	55,-	963-128	88,-
FKT 12K2LM	12	2	2	40	1	± 1	1	B	890,-	950-128	55,-	963-128	88,-
FKT 30K5LM	30	5	5	100	2,5	± 2,5	5	B	890,-	950-128	55,-	963-128	88,-
FKT 60K10LM	60	10	10	200	5	± 5	10	B	890,-	950-129	93,-	963-129	105,-

KERN scales – not scared of water at all!

Scales used in industrial situations or the food industry are often exposed to extreme stresses and strains. Water, oils, fats, varnish, dust, dirt, flour, small parts, etc. are all natural enemies of a scale. In industries such as the chemical, pharmaceutical, food, manufacturing industries, etc. scales must be able to cope with these stresses without this affecting their performance.





For use in such harsh environmental conditions, levels of protection are defined, which specify which environmental stresses a system can be exposed to with respect to the level of contact, foreign object and moisture protection, without damage being caused to the unit. These levels of protection are described in the following standard: "DIN EN 60529: protection types through housing"

The IP code usually consists of a two-digit combination, which gives the relevant level of protection, e.g. IP68. The first digit specifies the protection level for contact protection and protection against foreign bodies (dust protection), the second digit is for the water and moisture protection (protection against splashes of water).

All stainless steel components of the IP65...68 protected KERN stainless steel scales are made of corrosion-resistant steel of quality class 1.4301 (DIN X5CrNi18-10). The material properties support you in your → **HACCP**-compliant quality system.

→ See the glossary on page 214 – 216

Extract from the standard: "DIN EN 60529: protection types through housing":

KERN-Pictogram	1. digit	Specification	2. digit	Specification
	6	Dustproof	5	Designed for temporary contact with liquids. Use a damp cloth for cleaning.
	6	Dustproof	6	Protection against water jets.
	6	Dustproof	7	Designed for temporary use in wet areas. Temporary submersion is possible.
	6	Dustproof	8	Designed for continuous use in wet areas. Submersion is possible.





HIGH-LIGHT



from €
690,-
▶ page 82

KERN SXS

Your product specialist's recommendation:

-  **Scale entirely out of stainless steel**
-  **Protection against dust and water splashes IP67/68**
-  **A vast number of platform sizes available**
-  **Superior display size for the very best readout**



Lisa Mayer
Product specialist Stainless steel

Tel. +49 [0] 7433 9933-219
Fax +49 [0] 7433 9933-29219
lisa.mayer@kern-sohn.com

Quick-Finder Stainless steel/Protection against dust and water splashes IP65...68

Read-out	Weighing range	Model	Price excl. of VAT ex works €	Page	DAYS ready for shipping							
[d]	[Max]	KERN				For an explanation on the pictos, see the front flap						
0,1 g	0,5 kg	FOB 500-1S	79,-	74	1		●				●	
0,1 g	0,5 kg	FOB 0.5K-4NS	110,-	76	1		●			●	●	
0,2 g	1,5 kg	WTB 1K-4N	240,-	78	1		●		●	●		○
0,2 g	1,5 kg	FFN 1K-4N	275,-	79	1		●			●	●	●
0,5 g	1,5 kg	FOB 1.5K0.5	175,-	75	1		●			●		○
0,5 g	1,5 kg	WTB 1K-4NM	260,-	78	1	○	●		●	●		○
0,5 g	1,5 kg	FFN 1K-4NM	295,-	79	1	○	●			●	●	●
0,5 g	3 kg	WTB 3K-4N	240,-	78	1		●		●	●		○
0,5 g	3 kg	FFN 3K0.5IPN	275,-	79	1		●			●	●	●
0,5 g	3 kg	FXN 3K-4N	335,-	80	1		●		●	●		○
0,5 1 g	5 7,5 kg	FOB 7K-4NL	245,-	77	1		●			●	●	
1 g	1 kg	FOB 1K1M	195,-	75	1	○	●			●		○
1 g	3 kg	FOB 3K1	183,-	75	1		●			●		○
1 g	3 kg	WTB 3K-3NM	260,-	78	1	○	●		●	●		○
1 g	3 kg	FFN 3K1IPM	295,-	79	1	○	●			●	●	●
1 g	5 kg	FOB 5K1S	79,-	74	1		●			●	●	
1 g	5 kg	FOB 5K-3NS	105,-	76	1		●			●	●	
1 g	6 kg	WTB 6K-3N	240,-	78	1		●		●	●		○
1 g	6 kg	FFN 6K1IPN	275,-	79	1		●			●	●	●
1 g	6 kg	FXN 6K-3N	335,-	80	1		●		●	●		○
1 g	10 kg	SFB 10K1HIP	720,-	81	1		●	○	●	●	●	●
1 g	15 kg	FOB 15K1L	320,-	75	1		●			●	●	○
1 2 g	3 6 kg	SXS 6K-3M	690,-	82	1	○	●	○	●	●	●	●
1 2 g	8 15 kg	FOB 10K-3NL	245,-	77	1		●			●	●	
2 g	6 kg	FOB 6K2	180,-	75	1		●			●	●	○
2 g	6 kg	WTB 6K-3NM	260,-	78	1	○	●		●	●		○
2 g	6 kg	FFN 6K2IPM	295,-	79	1	○	●			●	●	●
2 g	15 kg	WTB 10K-3N	240,-	78	1		●		●	●		○
2 g	15 kg	FFN 15K2IPN	275,-	79	1		●			●	●	●
2 g	15 kg	FXN 10K-3N	335,-	80	1		●		●	●		○
2 g	20 kg	SFB 20K2HIP	720,-	81	1		●	○	●	●	●	●
2 g	30 kg	FOB 30K2L	320,-	75	1		●			●	●	○
2 5 g	6 15 kg	SXS 10K-3M	690,-	82	1	○	●	○	●	●	●	●
2 5 g	6 15 kg	SXS 10K-3LM	850,-	82	1	○	●	○	●	●	●	●
2 5 g	16 30 kg	FOB 30K-3NL	245,-	77	1		●			●	●	
5 g	15 kg	WTB 10K-3NM	260,-	78	1	○	●		●	●		○
5 g	15 kg	FFN 15K5IPM	295,-	79	1	○	●			●	●	●
5 g	15 kg	SFB 15K5HIPM	740,-	81	1		●	○	●	●	●	●
5 g	25 kg	FFN 25K5IPN	275,-	79	1		●			●	●	●
5 g	30 kg	WTB 30K-3N	240,-	78	1		●		●	●		○
5 g	30 kg	FXN 30K-3N	335,-	80	1		●		●	●		○
5 g	50 kg	SFB 50K5HIP	720,-	81	1		●	○	●	●	●	●
5 g	50 kg	SFB 50K5LHIP	770,-	81	1		●	○	●	●	●	●
5 g	50 kg	SFB 50K-3XL	890,-	81	1		●	○	●	●	●	●
5 10 g	15 30 kg	SXS 30K-2M	840,-	82	1	○	●	○	●	●	●	●
5 10 g	15 30 kg	SXS 30K-2LM	1160,-	82	1	○	●	○	●	●	●	●
10 g	25 kg	FFN 25K10IPM	295,-	79	1		●			●	●	●
10 g	30 kg	WTB 30K-2NM	260,-	78	1	○	●		●	●		○
10 g	30 kg	SFB 30K10HIPM	740,-	81	1	○	●	○	●	●	●	●
10 g	100 kg	SFB 100K10HIP	770,-	81	1		●	○	●	●	●	●
10 g	100 kg	SFB 100K-2L	890,-	81	1		●	○	●	●	●	●
10 g	100 kg	SFB 100K-2XL	1210,-	81	1		●	○	●	●	●	●
10 20 g	30 60 kg	SXS 60K-2M	850,-	82	1	○	●	○	●	●	●	●
10 20 g	30 60 kg	SXS 60K-2LM	1160,-	82	1	○	●	○	●	●	●	●
20 g	60 kg	SFB 60K20HIPM	740,-	81	1	○	●	○	●	●	●	●
20 g	60 kg	SFB 60K20LHIPM	810,-	81	1		●	○	●	●	●	●
20 g	60 kg	SFB 60K-2XLM	980,-	81	1	○	●	○	●	●	●	●
20 g	200 kg	SFB 200K-2XL	1210,-	81	1		●	○	●	●	●	●
20 50 g	60 150 kg	SXS 100K-2M	1150,-	82	1	○	●	○	●	●	●	●
20 50 g	60 150 kg	SXS 100K-2LM	1380,-	82	1	○	●	○	●	●	●	●
50 g	150 kg	SFB 100K-2HM	810,-	81	1		●	○	●	●	●	●
50 g	150 kg	SFB 100K-2LM	980,-	81	1	○	●	○	●	●	●	●
50 g	150 kg	SFB 100K-2XLM	1220,-	81	1	○	●	○	●	●	●	●
50 100 g	150 300 kg	SXS 300K-2M	1380,-	82	1	○	●	○	●	●	●	●
100 g	300 kg	SFB 300K-1LM	1220,-	81	1	○	●	○	●	●	●	●

● = Standard ○ = Option

Stainless steel bench scale KERN FOB-S



06

Economical stainless steel balance in a compact design

Features

- **Stainless steel design** of the housing and weighing plate. Its smooth surfaces make it simple to clean
- Your support in an **HACCP**-compliant quality system
- **High mobility:** thanks to compact, flat construction, it is suitable for use in several locations (kitchen, sales office, cafeteria, Food industry-Laboratory etc.)
- Secure and non-slip positioning through rubber feet
- **Ready for use:** battery 9 V Block standard, operating time up to 20 h

Technical data

- Large LCD display, digit height 20 mm
- Weighing plate dimensions, stainless steel WxD 120x150 mm
- Overall dimensions WxDxH 170x150x40 mm
- Permissible ambient temperature 10° C / 40° C

Accessories

- **Protective working cover** over keyboard and housing, not standard, can be reordered, scope of delivery: 5 items, KERN FOB-A11S05, **€ 50,-**
- **Mains adapter external**, not included, can be reordered, KERN FOB-A09, **€ 30,-**

STANDARD

CAL EXT
 INOX
 BATT
 DMS
 1 DAY
 2 YEARS WARRANTY

OPTION

230 V
 DAkkS +3 DAYS

Model	Weighing range [Max] kg	Readout [d] g	Net weight approx. kg	Weighing plate	Price excl. of VAT ex works €	Option	
						DAkkS Calibr. Certificate	
KERN						DKD KERN	€
FOB 500-1S	0,5	0,1	0,65	A	79,-	963-127	72,-
FOB 5K1S	5	1	0,65	A	79,-	963-127	72,-

Stainless steel bench scale KERN FOB



Stainless steel balance with special protection against humidity, also with EC-Type Approval [M]

Features

- **Stainless steel design** of the housing and weighing plate. Its smooth surfaces make it simple to clean
- **High mobility:** thanks to compact, flat construction, it is suitable for use in several locations (kitchen, sales office, market stall etc.)
- Secure and non-slip positioning through rubber feet
- Your support in an **HACCP**-compliant quality system
- **Increased protection against humidity** through waterproof silicone sealing of the load cell, electronics and soldering joints
- only FOB, FOB-L: **Net/Gross weight:** to control the consumed weighing range at the touch of a key

Technical data

- Large LCD display, digit height 25 mm
- Weighing plate dimensions, stainless steel WxD
 - A** 175x160 mm,
 - B** 215x215 mm
- Overall dimensions WxDxH
 - A** 175x235x60 mm,
 - B** 220x305x80 mm
- Net weight
 - A** approx. 1,95 kg,
 - B** approx. 3,3 kg,
- Permissible ambient temperature
KERN FOB: -10° C / 40° C
KERN FOB-M: 0° C / 40° C

Accessories

- **Protective working cover** over keyboard and housing, standard, can be reordered, scope of delivery: 5 items, for weighing plate size
 - A** KERN FOB-A05S05, **€ 35,-**
 - B** KERN FOB-A06S06, **€ 40,-**
- **Rechargeable battery pack internal**, for weighing plate size
 - A** operating time approx. 24 h without backlight, charging time approx. 8 h, KERN FOB-A07, **€ 45,-**
 - B** operating time approx. 30 h without backlight, charging time approx. 14 h, KERN FOB-A08, **€ 55,-**

STANDARD



OPTION



FACTORY



only FOB-M

Model	Weighing range [Max] kg	Readout [d] g	Verific. value [e] g	Minimum load [Min] g	Weighing plate	Price excl. of VAT ex works €	Options			
							Verification		DAkkS Calibr. Certificate	
							M III KERN	€	DKD KERN	€
FOB 1.5K0.5	1,5	0,5	-	-	A	175,-	-	-	963-127	72,-
FOB 3K1	3	1	-	-	A	183,-	-	-	963-127	72,-
FOB 6K2	6	2	-	-	A	180,-	-	-	963-128	88,-
FOB 15K1L	15	1	-	-	B	320,-	-	-	963-128	88,-
FOB 30K2L	30	2	-	-	B	320,-	-	-	963-128	88,-
Note: For applications that require verification, please order verification at the same time, initial verification at a later date is not possible. Verification at the factory, we need to know the full address of the location of use.										
FOB 1K1M	1	1	1	20	A	195,-	965-227	55,-	963-127	72,-



06

Particularly handy stainless steel balance with IP65 protection against dust and water splashes

Features

- **Stainless steel design** of the housing and weighing plate. Its smooth surfaces make it simple to clean
- **Particularly flat design**
- Your support in a **HACCP**-compliant quality system
- **High mobility:** thanks to compact, flat construction, it is suitable for use in several locations (kitchen, sales office, market stall etc.)
- Secure and non-slip positioning with rubber feet
- **IP65:** Protected against dust and water splashes (only when using battery)
- **Ready for use:** battery 9 V block standard, operating time up to 24 h

Technical data

- Large LCD display, digit height 20 mm
- Overall dimensions WxDxH 170x150x40 mm
- Permissible ambient temperature 10 °C / 35 °C

Accessories

- **Protective working cover** over keyboard and housing standard. Can be re-ordered, scope of delivery: 5 items KERN FOB-A12S05, **€ 30,-**
- **Mains adapter external**, not included, can be retrofitted, KERN FOB-A09, **€ 30,-**

STANDARD



OPTION



Model	Weighing range [Max] kg	Readout [d] g	Net weight approx. kg	Weighing plate mm	Price excl. of VAT ex works €	Option DAkkS Calibr. Certificate	
						DKD KERN	€
FOB 0.5K-4NS	0,5	0,1	0,7	150x120	110,-	963-127	72,-
FOB 5K-3NS	5	1	0,7	150x120	110,-	963-127	72,-

Stainless steel scale KERN FOB-N



06

Stainless steel bench scale with large weighing range and IP67 protection against dust and water splashes

Features

- **Stainless steel design** of the housing and weighing plate. Its smooth surfaces make it simple to clean
- Your support in a **HACCP**-compliant quality system
- **High mobility:** thanks to compact, flat construction, it is suitable for use in several locations (kitchen, sales office, market stall etc.)
- Secure and non-slip positioning with rubber feet
- **IP67:** Protected against dust and water splashes (only when using battery)
- **Ready for use:** batteries 4 x 1.5 V AA standard, operating time up to 66 h without backlight

Technical data

- Large backlit LCD display, digit height 25 mm
- Overall dimensions WxDxH 285x255x90 mm
- Permissible ambient temperature 5 °C / 35 °C

Accessories

- **Protective working cover** over keyboard and housing standard. Can be re-ordered, KERN FOB-A13S05, € 50,-
- **Mains adapter external**, not included, can be retrofitted, KERN FOB-A09, € 30,-

STANDARD



OPTION



Model	Weighing range [Max] kg	Readout [d] g	Net weight approx. kg	Weighing plate mm	Price excl. of VAT ex works €	Option DAkkS Calibr. Certificate	
						DKD KERN	€
KERN FOB 7K-4NL	5 7,5	0,5 1	3,75	252x200x14	245,-	963-128	88,-
KERN FOB 10K-3NL	8 15	1 2	3,75	252x200x14	245,-	963-128	88,-
KERN FOB 30K-3NL	16 30	2 5	3,75	252x200x14	245,-	963-128	88,-

IP protected bench scale KERN WTB-N



06

Ideal for food industry, thanks to its IP65 protection and special checkweighing display, now also with EC type approval [M]

Features

- **Suitable for the ever-increasing hygienic requirements in the food industry**
- **1 IP65:** Dust and spray protected (only when using rechargeable battery pack)
- Weighing plate stainless steel, removable, for easy cleaning
- **2 Second display** on the rear of the balance
- **Compact size**, practical for small spaces
- **3 Innovative weighing with tolerance range (Checkweighing):** The colour of the display changes depending on the weight (too light/ok/too heavy) and is an aid to help with portioning dosing and grading
- **High mobility** thanks to its rechargeable batteries (optional) and low weight

- **Recessed grips on the underside** of the scale for easy transportation
- Your support in a **HACCP-compliant** quality system

Technical data

- Large backlit LCD display, digit height 25 mm
- Weighing plate dimensions, stainless steel, WxD 260x200 mm
- Overall dimensions WxDxH 280x320x125 mm
- Net weight approx. 3,115 kg
- Permissible ambient temperature -10 °C / 40 °C

Accessories

- **Protective working cover** over keyboard and housing. Can be re-ordered, scope of delivery: 5 items, KERN RFB-A01S05, **€ 30,-**
- **Rechargeable battery pack internal**, operating time up to 50 h, charging time approx. 12 h, can be retrofitted, KERN WTB-A01N, **€ 35,-**
- **4 Tare pan made of stainless steel**, ideal for weighing loose fruit and vegetables, WxDxH 370x240x20 mm, for details see page 182, KERN RFS-A02, **€ 55,-**
- **Sturdy transport case** to protect and store the scale, dimensions WxDxH 510x360x220 mm, for details see page 182, KERN RFB-A02, **€ 95,-**

STANDARD



OPTION



FACTORY



Model	Weighing range [Max] kg	Readout [d] g	Verification value [e] g	Minimum load [Min] g	Price excl. of VAT ex works €	Options			
						Verification		DAkkS Calibr. Certificate	
						MID KERN	€	DKD KERN	€
WTB 1K-4N	1,5	0,2	-	-	240,-	-	-	963-127	72,-
WTB 3K-4N	3	0,5	-	-	240,-	-	-	963-127	72,-
WTB 6K-3N	6	1	-	-	240,-	-	-	963-128	88,-
WTB 10K-3N	15	2	-	-	240,-	-	-	963-128	88,-
WTB 30K-3N	30	5	-	-	240,-	-	-	963-128	88,-

Note: For applications that require verification, please order verification at the same time, initial verification at a later date is not possible. Verification at the factory, we need to know the full address of the location of use.

WTB 1K-4NM	1,5	0,5	0,5	10	260,-	965-227	55,-	963-127	72,-
WTB 3K-3NM	3	1	1	20	260,-	965-227	55,-	963-127	72,-
WTB 6K-3NM	6	2	2	40	260,-	965-228	55,-	963-128	88,-
WTB 10K-3NM	15	5	5	100	260,-	965-228	55,-	963-128	88,-
WTB 30K-2NM	30	10	10	200	260,-	965-228	55,-	963-128	88,-

IP protected bench scale KERN FFN-N



All-round bench scale, protected by stainless steel and IP65 rating, now also with EC type approval [M]

Features

- **1 Ideal for the food industry**
- **2 Ideal for the robust industrial applications**
- Your support in a **HACCP**-compliant quality system
- **High mobility:** thanks to battery operation, compact construction and low weight, it is suitable for use in several locations such as production, kitchen, sales office etc.
- **Stainless steel housing**, rust-proof and easy to clean
- **Recessed grips on the underside** of the scale for easy transportation
- **IP65:** Dust and spray protected (only when using rechargeable battery pack)

Technical data

- Large backlit LCD display, digit height 25 mm
- Weighing plate dimensions, stainless steel, WxD 230x190 mm
- Overall dimensions 230x298x125 mm
- **Rechargeable battery pack internal**, standard, operating time up to 50 h without backlight, charging time approx. 12 h. Can be re-ordered, KERN WTb-A01N, **€ 35,-**
- Net weight approx. 3,8 kg
- Permissible ambient temperature 0 °C / 40 °C

Accessories

- **Tare pan made of stainless steel**, ideal for weighing loose small parts, fruit, vegetables etc., WxDxH 370x240x20 mm, for details see page 182, KERN RFS-A02, **€ 55,-**

STANDARD



OPTION



FACTORY



Model	Weighing range [Max] kg	Readout [d] g	Verification value [e] g	Minimum load [Min] g	Price excl. of VAT ex works €	Options			
						Verification		DAkkS Calibr. Certificate	
						MDD KERN	€	DKD KERN	€
KERN FFN 1K-4N	1,5	0,2	-	-	275,-	-	-	963-127	72,-
FFN 3K0.5IPN	3	0,5	-	-	275,-	-	-	963-127	72,-
FFN 6K11PN	6	1	-	-	275,-	-	-	963-128	88,-
FFN 15K2IPN	15	2	-	-	275,-	-	-	963-128	88,-
FFN 25K5IPN	25	5	-	-	275,-	-	-	963-128	88,-

Note: For applications that require verification, please order verification at the same time, initial verification at a later date is not possible. Verification at the factory, we need to know the full address of the location of use.

FFN 1K-4NM	1,5	0,5	0,5	10	295,-	965-227	55,-	963-127	72,-
FFN 3K11PM	3	1	1	20	295,-	965-227	55,-	963-127	72,-
FFN 6K2IPM	6	2	2	40	295,-	965-228	55,-	963-128	88,-
FFN 15K5IPM	15	5	5	100	295,-	965-228	55,-	963-128	88,-
FFN 25K10IPM	25	10	10	200	295,-	965-228	55,-	963-128	88,-

IP protected bench scale KERN FXN



Robust, space-saving bench scale, protected by stainless steel and IP68 rating – now high resolution and with EC type approval [M]

Features

- Suitable for the ever-increasing hygienic requirements in the food industry
- Tough industry standard suitable for use in harsh industrial applications
- Your support in a HACCP-compliant quality system
- **IP68 protection:** very high class of protection against dust and water. Making it very robust and durable. Ideal for harsh ambient conditions. Submersion in water actually possible
- **Stainless steel housing,** rust-proof and easy to clean
- **Very fast display:** steady weight values within 2 sec
- **High mobility:** Battery operation, compact construction and low weight make this balance ideal for use in several locations (production, kitchen, sales office etc.)

- **1 Recessed grips on the underside** of the scale for easy transportation
- **Weighing with tolerance range (checkweighing):** Input of an upper/lower limit value. A visual and audible signal assists with portioning, dispensing or grading

Technical data

- Large backlit LCD display, digit height 25 mm
- Weighing plate dimensions, stainless steel, WxD 236x195 mm
- Overall dimensions WxDxH 240x280x120 mm
- Ready for use: Batteries included, 4 x 1.5 V Size D, operating time up to 200 h, AUTO-OFF function to preserve the batteries, can be switched off
- Net weight approx. 3,2 kg
- Permissible ambient temperature 0 °C / 40 °C

Accessories

- **2 Tare pan made of stainless steel,** ideal for weighing loose small parts, fruit, vegetables etc., WxDxH 370x240x20 mm, for details see page 182, KERN RFS-A02, € 55,-

STANDARD



OPTION



Model	Weighing range [Max] kg	Readout [d] g	Min. piece weight [Counting] g/piece	Price excl. of VAT ex works €	Option	
					DAkkS Calibr. Certificate	
					DKD KERN	€
FXN 3K-4N	3	0,5	0,5	335,-	963-127	72,-
FXN 6K-3N	6	1	1	335,-	963-128	88,-
FXN 10K-3N	15	2	2	335,-	963-128	88,-
FXN 30K-3N	30	5	5	335,-	963-128	88,-

Stainless steel platform scales KERN SFB · SFB-H



KERN SFB



3 KERN SFB-H



4 KERN BFS-A07

Stainless steel platform scales with IP65/67 protection, also with XL platform or EC type approval [M]

Features

- **Ideal for the robust industrial applications**
- Your support in a **HACCP**-compliant quality system
- **1 Platform: IP67**, made entirely of stainless steel, silicone-coated stainless load cell
- **2 Display device: IP65** (only when using rechargeable battery pack), stainless steel
- **3** only SFB-H: **column**, standard, for models with weighing plate size 300x240 mm: height of stand approx. 200 mm 400x300 mm: height of stand approx. 400 mm

Technical data

- Large backlit LCD display, digit height 52 mm
- Dimensions of display device WxDxH 266x165x96 mm
- Cable length of display device approx. 2 m
- **Rechargeable battery pack internal**, standard, operating time up to 35 h without backlight, charging time approx. 12 h. Can be re-ordered, KERN GAB-A04, € 40,-
- Permissible ambient temperature -10 °C / 40 °C

Accessories

- **Data interface RS-232**, interface cable included approx. 1.5 m, must be ordered at purchase, KERN KFN-A01, € 95,-
- **Stand** to be screwed onto the platform, height of stand approx. 600 mm, KERN SFB-A01, € 75,-
- **4 Stand**, height of stand 750-1000 mm, must be ordered at purchase, KERN BFS-A07, € 120,-
- **Suitable printers**, see page 177

STANDARD

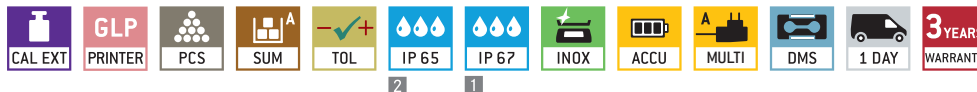

OPTION



FACTORY

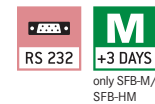

Model	Weighing range [Max] kg	Readout [d] g	Verification value [e] g	Minimum load [Min] g	Net weight approx. kg	Weighing plate WxD mm	Price excl. of VAT ex works €	Options			
								Verification		DAkkS Calibr. Certificate	
								M III KERN	€	DKD KERN	€
SFB 50K-3XL	50	5	-	-	15	500x400	890,-	-	-	963-128	88,-
SFB 100K-2L	100	10	-	-	15	500x400	890,-	-	-	963-129	105,-
SFB 100K-2XL	100	10	-	-	24,5	650x500	1210,-	-	-	963-129	105,-
SFB 200K-2XL	200	20	-	-	24,5	650x500	1210,-	-	-	963-129	105,-
with elevated display											
SFB 10K1HIP	10	1	-	-	9	300x240	720,-	-	-	963-128	88,-
SFB 20K2HIP	20	2	-	-	9	300x240	720,-	-	-	963-128	88,-
SFB 50K5HIP	50	5	-	-	9	300x240	720,-	-	-	963-128	88,-
SFB 50K5LHIP	50	5	-	-	14	400x300	770,-	-	-	963-128	88,-
SFB 100K10HIP	100	10	-	-	14	400x300	770,-	-	-	963-129	105,-
Note: For applications that require verification, please order verification at the same time, initial verification at a later date is not possible. Verification at the factory, we need to know the full address of the location of use.											
SFB 60K-2XLM	60	20	20	400	15	500x400	980,-	965-229	93,-	963-129	105,-
SFB 100K-2LM	150	50	50	1000	15	500x400	980,-	965-229	93,-	963-129	105,-
SFB 100K-2XLM	150	50	50	1000	24,5	650x500	1220,-	965-229	93,-	963-129	105,-
SFB 300K-1LM	300	100	100	2000	24,5	650x500	1220,-	965-229	93,-	963-129	105,-
with elevated display											
SFB 15K5HIPM	15	5	5	100	9	300x240	740,-	965-228	55,-	963-128	88,-
SFB 30K10HIPM	30	10	10	200	9	300x240	740,-	965-228	55,-	963-128	88,-
SFB 60K20HIPM	60	20	20	400	9	300x240	740,-	965-229	93,-	963-129	105,-
SFB 60K20LHIPM	60	20	20	400	14	400x300	810,-	965-229	93,-	963-129	105,-
SFB 100K-2HM	150	50	50	1000	14	400x300	810,-	965-229	93,-	963-129	105,-



- **Rechargeable battery pack internal**, standard, operating time up to 80 h without backlight, charging time approx. 12 h. Can be re-ordered, KERN GAB-A04, € 40,-
- Cable length of display device approx. 2,5 m

Accessories

- **Stand** to elevate display device, must be ordered at purchase, for models with weighing plate size
 - A - D:** height of stand approx. 200 mm, KERN IXS-A02, € 70,-
 - B - D:** height of stand approx. 400 mm, KERN IXS-A03, € 75,-
 - C - D:** height of stand approx. 600 mm, KERN IXS-A04, € 85,-
- **Data interface RS-232**, interface cable included approx. 1.5 m, must be ordered at purchase, KERN KXS-A04, € 40,-
- **Data interface RS-485**, must be ordered at purchase, KERN KXS-A01, € 85,-
- **Bluetooth data interface** for wireless data transfer to PC, must be ordered at purchase, KERN KXS-A02, € 110,-
- **Foot switch**, must be ordered at purchase, for details see page 181, KERN KXS-A03, € 70,-
- **Suitable printers** see page 177.

Stainless steel platform scale with stainless steel IP68 display and EC type approval [M]

Features

- **Ideal for the robust industrial applications**
- **1 Platform: IP67**, made entirely of stainless steel, silicone-coated stainless load cell. Substruction in wing design, extremely resistant to bending
- **2 Display device: IP68**, very high class of protection against dust and water. Integrated power supply. For further details on the KERN KXS-TM display device, see page 148
- **Suitable for the ever-increasing hygienic requirements in the food industry**
- **Wall mount standard**
- **Superior display size:** digit height 55 mm. Bright backlight for easy reading of weighing results, even in poor lighting conditions

- Thanks to the RS-232, RS-485 and Bluetooth (optional) **interfaces**, the scale can easily be connected to existing networks. Data exchange between the scale, PC or printer
- **ESD drain to protect against electrostatic discharge** e.g. for electrostatically-charged weighing objects or people who work with the scale

Technical data

- Large backlit LCD display, digit height 55 mm
- Weighing plate dimensions, stainless steel, WxDxH
 - A** 300x240x86 mm, **B** 400x300x89 mm
 - C** 500x400x123 mm, **D** 650x500x133.5 mm
- Dimensions of display device WxDxH 232x170x80 mm

STANDARD



OPTION



FACTORY

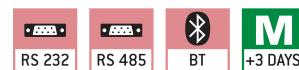

Model	Weighing range [Max] kg	Readout [d] g	Verification value [e] g	Minimum load [Min] g	Net weight approx. kg	Weighing plate	Price excl. of VAT ex works €	Options			
								Verification		DAkkS Calibr. Certificate	
								M III KERN	€	DKD KERN	€
SXS 6K-3M	3 6	1 2	1 2	20 40	5,1	A	690,-	965-228	55,-	963-128	88,-
SXS 10K-3M	6 15	2 5	2 5	40 100	5,1	A	690,-	965-228	55,-	963-128	88,-
SXS 10K-3LM	6 15	2 5	2 5	40 100	11,8	B	850,-	965-228	55,-	963-128	88,-
SXS 30K-2M	15 30	5 10	5 10	100 200	11,8	B	850,-	965-228	55,-	963-128	88,-
SXS 30K-2LM	15 30	5 10	5 10	100 200	20,8	C	1160,-	965-228	55,-	963-128	88,-
SXS 60K-2M	30 60	10 20	10 20	200 400	11,8	B	850,-	965-229	93,-	963-129	105,-
SXS 60K-2LM	30 60	10 20	10 20	200 400	20,8	C	1160,-	965-229	93,-	963-129	105,-
SXS 100K-2M	60 150	20 50	20 50	400 1000	20,8	C	1150,-	965-229	93,-	963-129	105,-
SXS 100K-2LM	60 150	20 50	20 50	400 1000	36,5	D	1380,-	965-229	93,-	963-129	105,-
SXS 300K-2M	150 300	50 100	50 100	1000 2000	36,5	D	1380,-	965-229	93,-	963-129	105,-

Dual-range balance switches automatically to the next largest weighing range [Max] and readout [d].

Note: For applications that require verification, please order verification at the same time, initial verification at a later date is not possible. Verification at the factory, we need to know the full address of the location of use.

Price computing scales

Price computing scales are used wherever the price of goods is calculated dependent on the weight of the goods. These scales are subject to obligatory verification (→ **Verification**) in accordance with European Directive 2009/23/EC. Usually, are verification class **MIII** scales.

KERN mobile retail scales are compact in size and therefore save space on the sales counter. Thanks to the simple menu structure they are easy to use – saving time and money.

Fitted with mains or rechargeable batteries as standard, price computing scales can be used in retail shops as well as on mobile sales stalls.

All price computing scales from KERN have three displays showing you all important information at a glance:

- Weight display in kg (verifiable)
- Unit price in €/kg or €/100 g
- Total price in €

Even the KERN entry level retail scales have direct access keys for memories (→ **PLU**). The sales item with the relevant price can be stored against these PLU. In this way, frequently used sales items can be called up at lightning speed. This accelerates customer service and reduces waiting times.

→ See the glossary on page 214 – 216

Quick-Finder Price computing scales

Read-out	Weighing range	Model	Price excl. of VAT ex works €	Page	DAYS ready for shipping	M	CAL EXT	MEMORY	RS 232	ACCU
[d]	[Max]	KERN				For an explanation on the pictos, see the front flap				
1 2 g	3 6 kg	RPB 6K1DM	225,-	84	1	○	●	●	●	○
1 2 g	3 6 kg	RPB 6K1DHM	250,-	84	1	○	●	●	●	○
2 5 g	6 15 kg	RPB 15K2DM	225,-	84	1	○	●	●	●	○
2 5 g	6 15 kg	RPB 15K2DHM	250,-	84	1	○	●	●	●	○
5 10 g	15 30 kg	RPB 30K5DM	225,-	84	1	○	●	●	●	○
5 10 g	15 30 kg	RPB 30K5DHM	250,-	84	1	○	●	●	●	○

● = Standard ○ = Option

Your product specialist's recommendation:

- Intuitive operation**
- Large number of item memories**
- Robust construction**



Lisa Mayer
Product specialist
Price computing scales

Tel. +49 [0] 7433 9933-219
Fax +49 [0] 7433 9933-29219
lisa.mayer@kern-sohn.com



from €
225,-
▶ page 84

KERN RPB



Application examples:

- retail shops
- market places
- farm shops
- pick your own fruit and vegetable sales

Note: Official verification duty for commercial trade

Retail scale with memories for item prices

Features

- **Elevated display** backlit, revolving on column, height of stand approx. 530 mm, only RPB-HM, must be ordered at purchase
- **Second display** on the rear of the balance, standard (only with models without the elevated indicator)
- **Three displays** for: weight (verifiable), unit price, total price
- **Unit price can be switched** from €/kg to €/100 g
- **Memory (PLU) for 10 article prices**
- **Auto-clear-key:** Unit price entry is automatically set to zero when scale is unloaded

- **High mobility** thanks to its rechargeable batteries (optional) and low weight

Technical data

- Large backlit LCD displays, digit height 20 mm
- Weighing plate dimensions, stainless steel, WxD 294x225 mm
- Overall dimensions WxDxH 320x350x125 mm
- Net weight
RPB: approx. 3,5 kg,
RPB-H: approx. 4,7 kg
- Permissible ambient temperature
-10 °C / 40 °C

Accessories

- **Protective working cover** standard. Can be re-ordered, scope of delivery: 5 items, KERN CFS-A02S05, **€ 40,-**
- **Rechargeable battery pack internal**, operating time up to 80 h without backlight, charging time approx. 14 h (internal charging via mains adapter). AUTO-OFF function to preserve the battery, can be switched off, KERN GAB-A04, **€ 40,-**
- **Tare pan made of stainless steel**, ideal for weighing loose fruit and vegetables, WxDxH 370x240x20 mm, for details see page 182, KERN RFS-A02, **€ 55,-**
- **Suitable printers** see page 177 ff.

STANDARD



OPTION



FACTORY



Model	Weighing range [Max] kg	Readout [d] g	Verification value [e] g	Minimum load [Min] g	Price excl. of VAT ex works €	Options			
						Verification		DAkkS Calibr. Certificate	
KERN							€		€
Dual-range balance switches automatically to the next largest weighing range [Max] and readout [d].									
RPB 6K1DM	3 6	1 2	1 2	20	225,-	965-228	55,-	963-128	88,-
RPB 15K2DM	6 15	2 5	2 5	40	225,-	965-228	55,-	963-128	88,-
RPB 30K5DM	15 30	5 10	5 10	100	225,-	965-228	55,-	963-128	88,-
with elevated display									
RPB 6K1DHM	3 6	1 2	1 2	20	250,-	965-228	55,-	963-128	88,-
RPB 15K2DHM	6 15	2 5	2 5	40	250,-	965-228	55,-	963-128	88,-
RPB 30K5DHM	15 30	5 10	5 10	100	250,-	965-228	55,-	963-128	88,-

Note: For applications that require verification, please order verification at the same time, initial verification at a later date is not possible. Verification at the factory, we need to know the full address of the location of use.



“Are you recording quantities manually in Goods Inwards? That’s old hat. The intelligent KERN PC balance systems are state-of-the-art, and make Goods Inwards and stocktaking simple and uncomplicated. They give precise values, quickly and flexibly and therefore save a lot of time and money.”

Dieter OBwald, KERN Goods Inwards

Interesting facts about density determination**Minimum piece weight**

Smallest piece the scale will accept for piece counting and piece count display. In practice, depending on the required accuracy, we recommend to choose a counting scale with a minimum piece weight smaller than the weight of the item to be counted.

→ Counting resolution

Describes the maximum quantity which can be counted with a counting accuracy of 1 %, with a minimum variation of item weights and a sufficiently large → **reference quantity** (20 pieces with counting resolution ≤ 60,000 points, 50 pieces from 60,000 – 150,000 points, 100 pieces ≥ 150,000 points). This therefore is an indication of the quality of the counting scale.

Recommended → reference quantity

Weight tolerances of pieces to be counted are the the most significant sources of error when counting. Therefore, at the start of every counting procedure, establish an average weight, the so-called → **reference weight**, by placing several pieces on the scale, the so-called reference quantity. Usually this would be:

- 5 pieces >> often sufficient
- 10 pieces >> common practise
- 20 – 100 pieces >> for large deviations among piece weights

The “automatic → **reference optimisation**“ function increases the reference quantity gradually, whereby the average piece weight is optimised step by step. This contributes considerably to the accuracy of the subsequent counting processes.

Which counting scale for which application?**Simple counting scale**

with self-explanatory user guidance on the keyboard. The graphic control panel enables you to start working immediately, without having to consult the user manual. Easy handling, value for money.

Professional counting scale

with 3 separate displays for reference weight (average weight of the pieces), total weight of all pieces and total quantity of all pieces. Very useful integrated memories, e.g. for container weight, item number, reference weight as well as audible and visual counting aids and an alphanumeric key pad for easy data entry.

Special tip for counting large quantities:**Counting systems**

The weighing ranges of bench counting scales are often not sufficient to count large quantities, units, palletized items, etc. Here high-performance counting systems come into operation, as these combine a high-precision reference scale with a high-capacity bulk scale.

Special stocktaking scales SMT, FKA and FKC

For demanding quantity measurement, e.g. as part of a stocktake. With its easy-to-use touch screen, special stocktaking software and PC connection this makes it quicker to collect and analyse stock levels

→ See the glossary on page 214 – 216



only €

950,-

▶ page 96

KERN FKA

Your product specialist's recommendation:

Intelligent, rapid inventory system



Enormous item memory



Intuitive touchscreen operation



Tanja Jetter









Product specialist Counting scales

Tel. +49 [0] 7433 9933 - 168

Fax +49 [0] 7433 9933 - 29168

tanja.jetter@kern-sohn.com

Quick-Finder Counting scales/Counting systems/Special stocktaking scales

Read-out [d]	Weighing range [Max]	Model KERN	Price excl. of VAT ex works €	Page	 DAYS ready for shipping							
For an explanation on the pictos, see the front flap												
1 2 g	3 6 kg	IFS 6K-3M	410,-	93	1	○	●		●		●	○
1 2 g	3 6 kg	IFS 100K-3L	750,-	93	1	○	●		●		●	○
1 2 g	75 150 kg	IFS 100K-3	610,-	93	1		●		●		●	○
1 2 g	600 kg	CCP 600K-3	3800,-	100	2		●	●	●		●	
2 g	6 kg	CXB 6K2NM	245,-	89	1	○	●				●	●
2 g	30 kg	CXB 30K2	230,-	89	1		●				●	●
2 5 g	6 15 kg	CPB 15K2DM	235,-	90	1	○	●		●		●	○
2 5 g	6 15 kg	IFS 10K-3M	410,-	93	1	○	●		●		●	○
2 5 g	6 15 kg	IFS 10K-3LM	460,-	93	1	○	●		●		●	○
2 5 g	150 kg	CCP 100K-3	2600,-	100	2		●	●	●		●	
2 5 g	150 300 kg	IFS 300K-3	750,-	93	1		●		●		●	○
5 g	15 kg	CXB 15K5NM	245,-	89	1	○	●				●	●
5 10 g	15 30 kg	CPB 30K5DM	235,-	90	1	○	●		●		●	○
5 10 g	15 30 kg	IFS 30K-3M	460,-	93	1	○	●		●		●	○
10 g	30 kg	CXB 30K10NM	245,-	89	1	○	●				●	●
10 20 g	30 60 kg	IFS 60K-2M	460,-	93	1	○	●		●		●	○
10 20 g	30 60 kg	IFS 60K-2LM	550,-	93	1	○	●		●		●	○
20 50 g	60 150 kg	IFS 100K-2M	550,-	93	1	○	●		●		●	○
20 50 g	60 150 kg	IFS 100K-2LM	690,-	93	1	○	●		●		●	○
50 100 g	150 300 kg	IFS 300K-2M	690,-	93	1	○	●		●		●	○

■ = News 2016

4* = Delivery by truck, please ask for prices

● = Standard

○ = Option

Are you looking for higher capacity counting scales?

We have just the right product for you!

All floor scales, pallet scales and drive-through scales from product group 10 (pages 123-139) can be put together to create a high-capacity counting system using the built-in RS-232 or DUAL interface.

Your KERN product specialist for counting scales and counting systems, Mrs Tanja Jetter will be pleased to advise you.



Tanja Jetter

Product specialist Counting scales

Tel. +49 [0] 7433 9933-168
Fax +49 [0] 7433 9933-29168
tanja.jetter@kern-sohn.com



Counting scale KERN CXB



Note: Official verification duty for commercial trade. The verification only refers to the weight of the counted parts

Entry level model into professional counting, also with EC type approval [M], counting resolution of 30,000 points

Features

- **Precise counting:** The automatic reference weight optimisation of reference weight gradually improves the average piece weight value
- **Programmable using numerical key pad:**
 - required reference quantity
 - known reference weight
- **Three displays for**
 - Total weight (verifiable)
 - Piece weight
 - Total count
- **Audible Fill-to-target:** target quantity or target weight can be programmed. When the target value is reached, a signal will sound
- **Counting results memory:** adds up all individual piece counts, result is shown in total weight and total pieces

- **Energy management:** Backlight turns off after 5 sec
- **Two balances in one:** Changes from counting mode to weighing mode at the touch of a key
- **PRE-TARE function** for manual subtraction of a known container weight, value can be saved

Technical data

- Large backlit LCD displays, digit height 18 mm
- Weighing plate dimensions, stainless steel, WxD 300x225 mm
- Dimensions housing WxDxH 300x330x110 mm
- **Rechargeable battery pack internal,** standard, operating time up to 200 h without backlight, charging time approx. 8 h

- Net weight approx. 4 kg
- Permissible ambient temperature -10 °C / 40 °C

Accessories

- **Protective working cover** over keyboard and housing, standard. Can be re-ordered, scope of delivery: 5 items, KERN CXB-A01S05, € 36,-
- **Rechargeable battery pack internal,** operating time up to 70 h without backlight, charging time approx. 14 h, KERN GAB-A04, € 40,-

STANDARD



OPTION



FACTORY



Model	Weighing range [Max] kg	Readout [d] g	Verification value [e] g	Minimum load [Min] g	Min. piece weight [Counting] g/piece	Counting resolution Points	Price excl. of VAT ex works €	Options			
								Verification		DAkkS Calibr. Certificate	
								KERN	€	DKD KERN	€
KERN CXB 3K0.2	3	0,2	-	-	0,1	30.000	230,-	-	-	963-127	72,-
KERN CXB 6K0.5	6	0,5	-	-	0,2	30.000	230,-	-	-	963-128	88,-
KERN CXB 15K1	15	1	-	-	0,5	30.000	230,-	-	-	963-128	88,-
KERN CXB 30K2	30	2	-	-	1	30.000	230,-	-	-	963-128	88,-
Note: For applications that require verification, please order verification at the same time, initial verification at a later date is not possible. Verification at the factory, we need to know the full address of the location of use.											
KERN CXB 3K1NM	3	1	1	20	0,1	30.000	245,-	965-227	55,-	963-127	72,-
KERN CXB 6K2NM	6	2	2	40	0,2	30.000	245,-	965-228	55,-	963-128	88,-
KERN CXB 15K5NM	15	5	5	100	0,5	30.000	245,-	965-228	55,-	963-128	88,-
KERN CXB 30K10NM	30	10	10	200	1	30.000	245,-	965-228	55,-	963-128	88,-

Counting scale KERN CPB

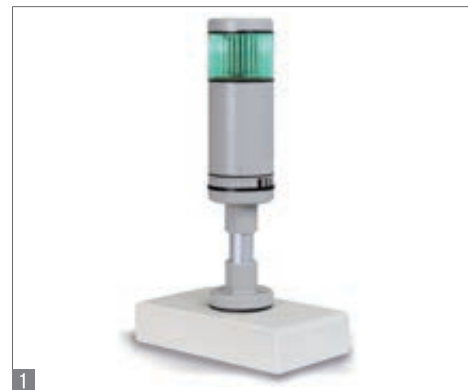

Note:

Official verification duty for commercial trade. The verification only refers to the weight of the counted parts

Professional model, also with EC type approval [M], counting resolution up to 60,000 points

Features

- **Precise counting:** The automatic reference weight optimisation of reference weight gradually improves the average piece weight value
- **Programmable using numerical key pad:**
 - required reference quantity
 - known reference weight
- **Three displays for**
 - Total weight (verifiable)
 - Piece weight
 - Total count
- **Audible Fill-to-target:** target quantity or target weight can be programmed. When the target value is reached, a signal will sound
- **Counting results memory:** adds up all individual piece counts, result is shown in total weight and total pieces

- **PRE-TARE function** for manual subtraction of a known container weight, value can be saved
- **Energy management:** Backlight turns off after 5 sec
- **Two balances in one:** Changes from counting mode to weighing mode at the touch of a key

Technical data

- Large backlit LCD displays, digit height 20 mm
- Weighing plate dimensions, stainless steel, WxD 295x225 mm
- Overall dimensions WxDxH 320x350x125 mm
- Net weight approx. 3,2 kg
- Permissible ambient temperature 0 °C / 40 °C

Accessories

- **Protective working cover**, can be retrofitted, scope of delivery: 5 items, KERN CFS-A02S05, € 40,-
- **Rechargeable battery pack internal**, operating time up to 90 h without backlight, charging time approx. 12 h, can be retrofitted, KERN GAB-A04, € 40,-
- **Signal lamp** for visual support of weighing with tolerance range, for details see page 181, KERN CFS-A03, € 250,-
- **Y-cable** for parallel connection of two terminal devices to the RS-232 interface on the scale, e.g. signal lamp and printer, for details see page 181, KERN CFS-A04, € 35,-
- **Suitable printers** and further, extensive accessories from page 177 ff.

STANDARD



OPTION



FACTORY



Model	Weighing range [Max] kg	Readout [d] g	Verification value [e] g	Minimum load [Min] g	Min. piece weight [Counting] g/piece	Price excl. of VAT ex works €	Options			
							Verification		DAkkS Calibr. Certificate	
							MID KERN	€	DKD KERN	€
KERN CPB 6K0.1N	6	0,1	-	-	0,1	235,-	-	-	963-128	88,-
KERN CPB 15K0.2N	15	0,2	-	-	0,25	235,-	-	-	963-128	88,-
KERN CPB 30K0.5N	30	0,5	-	-	0,5	235,-	-	-	963-128	88,-
Note: For applications that require verification, please order verification at the same time, initial verification at a later date is not possible. Verification at the factory, we need to know the full address of the location of use.										
Dual-range balance switches automatically to the next largest weighing range [Max] and readout [d].										
KERN CPB 6K1DM	3 6	1 2	1 2	20	0,1	235,-	965-228	55,-	963-128	88,-
KERN CPB 15K2DM	6 15	2 5	2 5	40	0,25	235,-	965-228	55,-	963-128	88,-
KERN CPB 30K5DM	15 30	5 10	5 10	100	0,5	235,-	965-228	55,-	963-128	88,-

Counting scale KERN CFS



Professional, high-resolution counting scale with 100 item memories and second balance interface, counting resolution up to 75,000 points

Features

- **Memory (PLU) for 100 items** with additional text, reference weight and tare weight, e.g. of a container
- **Precise counting:** The automatic reference weight optimisation of reference weight gradually improves the average piece weight value
- **Programmable using numerical key pad:**
 - required reference quantity
 - known reference weight
- **Weighing with tolerance range (checkweighing)**, ideal for portioning, dispensing, grading, only in weighing and counting mode
- **Fill-to-target function:** Programmable target quantity or target weight. An acoustic and visual signal will be displayed when the target value is reached
- **PRE-TARE function** for manual subtraction of a known container weight, value can be saved

- **Second balance interface** to construct a high-resolution counting system, standard, e.g. with weighing bridges KERN KFP V20 (see page 150)

Technical data

- Large backlit LCD displays, digit height 20 mm
- Weighing plate dimensions, stainless steel,
 - A** Ø 80 mm
 - B** WxD 300x225 mm, see enlarged picture
 - C** WxD 370x240 mm
- Overall dimensions WxDxH
 - A** 320x350x180 mm (incl. draught shield),
 - B** 320x340x130 mm
 - C** 370x375x130 mm
- Permissible ambient temperature 0 °C / 40 °C

Accessories

- **Protective working cover** over keyboard and housing standard, only for models with weighing plate size **B**. Can be re-ordered, scope of delivery: 5 items, KERN CFS-A02S05, **€ 40,-**
- **Rechargeable battery pack internal**, operating time up to 70 h without backlight, charging time approx. 14 h, can be retrofitted, KERN GAB-A04, **€ 40,-**
- **Signal lamp** for visual support of weighing with tolerance range, WxDxH 100x180x300 mm, KERN CFS-A03, **€ 250,-**
- **Y-cable** for parallel connection of two terminal devices to the RS-232 interface on the scale, e.g. signal lamp and printer, KERN CFS-A04, **€ 35,-**
- **Suitable printers** and further, extensive accessories from page 177 ff.

STANDARD

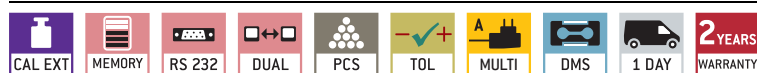

OPTION



Model	Weighing range [Max] kg	Readout [d] g	Min. piece weight [Counting] g/piece	Net weight approx. kg	Weighing plate	Price excl. of VAT ex works €	Option DAkKS Calibr. Certificate	
							DKD KERN	€
CFS 300-3	0,3	0,001	0,005	2,5	A	350,-	963-127	72,-
CFS 3K-5	3	0,01	0,05	3,3	B	300,-	963-127	72,-
CFS 6K0.1	6	0,1	0,1	3,3	B	270,-	963-128	88,-
CFS 15K0.2	15	0,2	0,2	3,3	B	270,-	963-128	88,-
CFS 30K0.5	30	0,5	0,5	3,3	B	270,-	963-128	88,-
CFS 50K-3	50	1	1	4,4	C	300,-	963-128	88,-

Counting scale KERN CKE

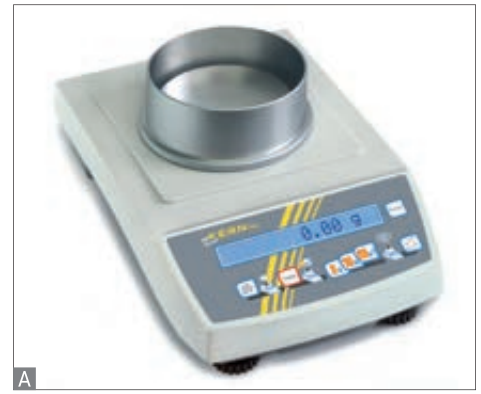

Easy to use, self-explanatory counting scale with laboratory accuracy, counting resolution up to 360,000 points

Features

- **Self-explanatory graphic control panel**, counting process can be understood immediately, even without operating instructions.
 - no learning time = reduces costs
 - ideal for untrained users
 - visualised process avoids operating errors
- The 4 steps are carried out from left to right:
 - 1 Place the empty container onto the weighing plate and tare by pressing the TARE key
 - 2 Place the reference quantity for the goods to be counted into the container (5, 10 or 20 pieces)
 - 3 Confirm the selected reference quantity by pressing the key (5, 10 or 20)
 - 4 Pour in the goods to be counted. The number of pieces will immediately be shown in the display
- **Precise counting:** The automatic reference weight optimisation of reference weight

gradually improves the average piece weight value

- **Two scales in one:** Switching from counting mode to weighing mode at the touch of a key

Technical data

- Large backlit LCD display
 - A, B digit height 9 mm, C digit height 18 mm
- Weighing plate dimensions, stainless steel*
 - A Ø 81 mm, B WxD 150x170 mm*
 - C WxD 340x240 mm*, see enlarged picture
- Overall dimensions WxDxH
 - A, B 167x250x85 mm, C 350x390x120 mm
- Optional battery operation for models with weighing plate size C, batteries 6 x 1.5 V Size C not standard, operating time up to 40 h
- Net weight for models with weighing plate size
 - A approx. 1 kg
 - B approx. 1,8 kg
 - C approx. 6,5 kg

- Permissible ambient temperature 10 °C / 40 °C

Accessories

- **Protective working cover** over keyboard and housing standard. Can be re-ordered, scope of delivery: 5 items, for models with weighing plate size
 - A KERN PCB-A02S05, € 30,-
 - B KERN PCB-A05S05, € 30,-
 - C KERN FKB-A02S05, € 30,-
- **Rechargeable battery pack external**, operating time up to 25 hours with backlight, charging time approx. 10 h, KERN KS-A01, € 180,-
- **Rechargeable battery pack internal** only for models with weighing plate size A and B, operating time up to 25 hours with backlight, charging time approx. 10 h, can be retrofitted, KERN KB-A01N, € 50,-
- **Suitable printers** and further, extensive accessories from page 177 ff.

STANDARD



OPTION



Model	Weighing range [Max] kg	Readout [d] g	Min. piece weight [Counting] g/piece	Counting resolution Points	Weighing plate	Price excl. of VAT ex works €	Option DAkkS Calibr. Certificate	
							DKD KERN	€
KERN CKE 360-3	0,36	0,001	0,001	360000	A	310,-	963-127	72,-
KERN CKE 2000-2	2	0,01	0,01	200000	B	350,-	963-127	72,-
KERN CKE 3600-2	3,6	0,01	0,01	360000	B	370,-	963-127	72,-
KERN CKE 6K0.02	6	0,02	0,02	300000	C	500,-	963-128	88,-
KERN CKE 8K0.05	8	0,05	0,05	160000	C	460,-	963-128	88,-
KERN CKE 16K0.05	16	0,05	0,05	320000	C	560,-	963-128	88,-
KERN CKE 16K0.1	16	0,1	0,1	160000	C	460,-	963-128	88,-
KERN CKE 36K0.1	36	0,1	0,1	360000	C	520,-	963-128	88,-
KERN CKE 65K0.2	65	0,2	0,2	325000	C	520,-	963-129	105,-
KERN CKE 65K0.5	65	0,5	0,5	130000	C	480,-	963-129	105,-

Counting scale KERN IFS



Note:

Official verification duty for commercial trade. The verification only refers to the weight of the counted parts

Industrial counting scale with convenient decimal keypad for easy data entry - now also with EC type approval [M], counting resolution up to 75000 points

Features

- **Industrial quality:** heavy version for tough usage in industrial applications
- **Ergonomic display device** with large keypad and high-contrast LCD display for easy entry and reading of, e.g., tare weights, reference weights, limit values etc., for details see page 147, KERN KFS-TM
- **99 item memories** for master data such as reference weight, reference quantity, container weight (PRE-TARE) etc.

- **Precise counting:** The manual reference weight optimisation gradually improves the average value of the piece weight
- **Totalising** of pieces when counting

Technical data

- Large backlit LCD displays, digit height 16 mm
- Dimensions of display device WxDxH 260x150x65 mm
- Cable length of display device approx. 3 m
- Permissible ambient temperature 0 °C / 40 °C

Accessories

- **Protective working cover** standard. Can be re-ordered, scope of delivery: 5 items, KERN KFB-A02S05, **€ 35,-**
- **Stand** to elevate display device, height of stand approx. 330 mm, KERN IFB-A01, **€ 50,-**
height of stand approx. 600 mm, for models with weighing plate size $\geq 500 \times 400 \times 137$ mm, KERN IFB-A02, **€ 60,-**
- **Rechargeable battery pack internal**, operating time up to 40 h, charging time approx. 12 h, must be ordered at purchase, KERN KFS-A01, **€ 35,-**
- **Suitable printers** see page 177 ff.

STANDARD



OPTION



FACTORY



Model	Weighing range [Max] kg	Readout [d] g	Verific. value [e] g	Min. piece weight [Counting] g/piece	Counting resolution Points	Net weight approx. kg	Weighing plate WxDxH mm	Price excl. of VAT ex works €	Options			
									Verification		DAkkS Calibr. Certificate	
KERN								M KERN	€	DKD KERN	€	
Dual-range balance switches automatically to the next largest weighing range [Max] and readout [d].												
IFS 10K-4	6 15	0,1 0,2		0,2	75.000	6,5	300x240x110	400,-	-	-	963-128	88,-
IFS 30K0.2DL	12 30	0,2 0,5		0,5	60.000	10	400x300x128	430,-	-	-	963-128	88,-
IFS 60K0.5D	30 60	0,5 1		1	60.000	10	400x300x128	430,-	-	-	963-129	105,-
IFS 60K0.5DL	30 60	0,5 1		1	60.000	16	500x400x137	520,-	-	-	963-129	105,-
IFS 100K-3	75 150	1 2		2,5	60.000	16	500x400x137	610,-	-	-	963-129	105,-
IFS 100K-3L	75 150	1 2		2,5	60.000	24	650x500x142	750,-	-	-	963-129	105,-
IFS 300K-3	150 300	2 5		5	60.000	24	650x500x142	750,-	-	-	963-129	105,-
Note: For applications that require verification, please order verification at the same time, initial verification at a later date is not possible. Verification at the factory, we need to know the full address of the location of use.												
IFS 6K-3M	3 6	1 2	1 2	0,1	60.000	6,5	300x240x110	410,-	965-228	55,-	963-128	88,-
IFS 10K-3M	6 15	2 5	2 5	0,2	75.000	6,5	300x240x110	410,-	965-228	55,-	963-128	88,-
IFS 10K-3LM	6 15	2 5	2 5	0,2	75.000	10	400x300x128	460,-	965-228	55,-	963-128	88,-
IFS 30K-3M	15 30	5 10	5 10	0,5	60.000	10	400x300x128	460,-	965-228	55,-	963-128	88,-
IFS 60K-2M	30 60	10 20	10 20	1	60.000	10	400x300x128	460,-	965-229	93,-	963-129	105,-
IFS 60K-2LM	30 60	10 20	10 20	1	60.000	16	500x400x137	550,-	965-229	93,-	963-129	105,-
IFS 100K-2M	60 150	20 50	20 50	2,5	60.000	16	500x400x137	550,-	965-229	93,-	963-129	105,-
IFS 100K-2LM	60 150	20 50	20 50	2,5	60.000	24	650x500x142	690,-	965-229	93,-	963-129	105,-
IFS 300K-2M	150 300	50 100	50 100	5	60.000	24	650x500x142	690,-	965-229	93,-	963-129	105,-



08

Easy to use industrial counting scale for heavy loads, counting resolution up to 300,000 points

Features

• Self-explanatory graphic control panel.

The counting process can be understood immediately even without operating instructions

- No learning time = reduces costs
- Ideal for untrained users
- Visualised process avoids operating errors
- The 4 steps are carried out from left to right:
 - 1 Place the empty container onto the weighing plate and tare by pressing the TARE key
 - 2 Place the reference quantity for the goods to be counted into the container (5, 10 or 20 pieces)
 - 3 Confirm the selected reference quantity by pressing the key (5, 10 or 20)
 - 4 Pour in the goods to be counted.

The number of pieces will immediately be shown in the display

- **Precise counting:** The automatic reference weight optimisation of reference weight gradually improves the average piece weight value

Technical data

- Backlit LCD display, digit height 18 mm
- Weighing plate dimensions, stainless steel, WxDxH
 - A 228x228x90 mm
 - B 308x318x75 mm
 - C 450x350x115 mm
- Dimensions of display device WxDxH 225x115x60 mm
- Permissible ambient temperature 10 °C / 40 °C

Accessories

- **Protective working cover** over the display device, standard. Can be re-ordered, scope of delivery: 5 items, KERN DE-A12S05, € 30,-
- **Wall mount** for display device, KERN DS-A02, € 30,-
- **Mount** to fasten the display device to the platform, KERN DE-A11N, € 35,-
- **5 Stand** to elevate display device, height of stand approx. 480 mm, KERN DE-A10, € 95,-
- **Rechargeable battery pack external**, operating time up to 15 hours with backlight, charging time approx. 10 h, KERN KS-A01, € 180,-
- **Rechargeable battery pack internal**, operating time up to 15 hours with backlight, charging time approx. 10 h, can be retrofitted, KERN KB-A01N, € 50,-
- **Set for suspended weighing**, consists of platform, bow, hook, only for models with weighing plate B, KERN DS-A01, € 200,-
- **Suitable printers** and further, extensive accessories from page 177 ff.

STANDARD



OPTION



only B

Model	Weighing range [Max] kg	Readout [d] g	Min. piece weight [Counting] g/piece	Counting resolution Points	Net weight approx. kg	Cable length approx. m	Weighing plate	Price excl. of VAT ex works €	Option DAKkS Calibr. Certificate	
									DKD KERN	€
CDS 4K0.02	4	0,02	0,02	200.000	5,1	2	A	560,-	963-127	72,-
CDS 15K0.05	15	0,05	0,05	300.000	7,5	2	B	490,-	963-128	88,-
CDS 16K0.1	16	0,1	0,1	160.000	7,5	2	B	460,-	963-128	88,-
CDS 30K0.1	30	0,1	0,1	300.000	7,5	2	B	560,-	963-128	88,-
CDS 30K0.1L	30	0,1	0,1	300.000	9,5	0,6	C	690,-	963-128	88,-
CDS 36K0.2L	36	0,2	0,2	180.000	9,5	0,6	C	690,-	963-128	88,-
CDS 60K0.2	60	0,2	0,2	300.000	9,5	0,6	C	690,-	963-129	105,-
CDS 100K0.5	100	0,5	0,5	200.000	9,5	0,6	C	710,-	963-129	105,-

KERN

Stocktaking scales



Stocktaking in an instant

Save valuable time and money with application oriented balance-PC systems for rapid and reliable recording of stock levels. From the simple determination of weights in day-to-day operations, through its beneficial use as a checkweigher in Goods Inwards or picking small parts, to professional recording of your entire stock levels within the scope of a regular inventory – with the **KERN inventory system** you are always in safe hands.

KERN FKA and FKC – 2 trusty helpers

- » Barcode scanner can be connected for rapid item recognition
- » Easy selection of archived items using the practical search function
- » Rapid data transfer, e.g. excel stock lists from PC to the balance or recorded stock levels from the balance to the PC
- » It is possible to print out individual item stocks immediately using a printer
- » Up to 16 individual receipt print outs (also with company address) can be easily designed on the PC or the balance and archived in the balance
- » Used as a counting system the KERN FKC can achieve counting resolutions of up to 5 million parts with a high degree of accuracy
- » An inventory system which can be used in any location, and is easy to transport thanks to its compact dimensions and operation on battery or rechargeable battery

Your benefit

- Thanks to the stored item data, such as item name, piece weight, reference quantity, tare values of the packaging or storage boxes etc. this information does not to be recorded during the stocktake. That is a huge time saver
- There is no need for a separate stock list in paper form – which prevents information being entered wro
- When using a barcode scanner, the sources of error in confusion of items is practically eliminated – which ensures process reliability and accurate inventory data
- The recorded item stock can be printed out immediately and then put in the storage box or stuck on using the label printer – item specific with user, item description, date, time and quantity
- Items which are not in the database can easily be recorded on the balance and be transferred onto the stock list – which means the maximum flexibility when stocktaking
- For archived items, daily totals can be determined and transferred to the PC – in this way you are kept informed of the progress of the inventory at all times
- When using the KERN FKC counting system you can achieve extremely high counting resolutions of up to 5 million parts with a high degree of accuracy – which means that inventory data is accurate in just one work process and therefore save a lot of time

Stocktake scale KERN FKA



See for yourself just how easy **Goods Inwards** can be, with KERN ...



Stocktake scale with touchscreen to quickly measure the quantity of stock items and transfer the information to the PC

Features

- Application-orientated balance-PC system for rapid and reliable recording of stock levels, e.g. as part of a stocktake or goods inwards control
- **Using the software included as standard**, an excel list produced by a PC with stocktake items can be transferred to the balance. In the warehouse, stocktake items can then be weighed, counted and stored by the balance, while still in their containers. In doing this, the stored container weight will be subtracted automatically. After the stocktake, the stock level will then be transferred back to the PC and can then be processed further as an excel table. In this way the amount of work and input at the balance is kept to a minimum and time efficiency is maximised = saves costs
- **High Flexibility:** During stocktaking, stored PRE-TARE can be corrected immediately on the scale. Items which have not yet been recorded can easily entered using the scale and then transferred in the stock level list

- **1000 item memories** for master data, such as item number, PRE-TARE (container weight), reference quantity, refere, weight etc.
- During stocktaking it is possible to print individual items recorded
- Barcode scanner can be connected for rapid item recognition, with no confusion

Technical data

- Backlit and touch-sensitive LCD display with digit height 18 mm, screen diagonal 5.8" (approx. 147 mm)
- Dimensions housing WxDxH 350x390x120 mm
- Optional battery operation, 6 x 1.5 V Size C not included, operating time up to 15 h
- Net weight approx. 6,5 kg
- Permissible ambient temperature 10 °C / 40 °C

Accessories

- **Protective working cover** over keyboard and housing, standard. Can be re-ordered, scope of delivery: 5 items, KERN FKB-A02S05, **€ 30,-**
- **Rechargeable battery pack external**, operating time up to 20 h without backlight, charging time approx. 10 h, KERN KS-A01, **€ 180,-**
- **Barcode scanner**, table-top version, dimensions WxDxH 230x150x135 mm, KERN SMT-A02, **€ 685,-**
- **Barcode scanner**, hand-held version, dimensions WxDxH 235x210x115 mm, KERN SMT-A03, **€ 445,-**
- **Radio barcode scanner**, hand-held version, dimensions WxDxH 225x220x110 mm, KERN SMT-A04, **€ 495,-**
- **Converter cable (RS-232 to USB)**, KERN AFH 12, **€ 85,-**
- **Y-cable**, KERN FKA-A01, **€ 46,-**
- **Suitable printers** and further, extensive accessories from page 177 ff.

STANDARD



OPTION



Model	Weighing range [Max] kg	Readout [d] g	Min. piece weight [Counting] g/piece	Weighing plate WxD mm	Price excl. of VAT ex works €	Option DAkks Calibr. Certificate	
						DKD KERN	€
FKA 30K-4	36	0,1	0,1	340x240	950,-	963-128	88,-
FKA 60K-4	65	0,2	0,2	340x240	950,-	963-129	105,-

Price reduction



You will be impressed with how easy stocktaking is now, with KERN ...



Quantity scale KERN FKA

Reference scale KERN KB-N

Stocktaking scale with touchscreen to quickly measure the quantity of stock items and information to the PC

Features

- **Counting with a reference balance for high counting accuracy:** the highly accurate KERN FKC counting system can replace a whole range of individual balances, efficiently and at a reasonable price.
- The counting system consists of an FKA bulk scale FKA (see p. 96 for details) and a KB-N reference balance KB-N (details see page 25) as well as an interface cable
- Application-orientated balance-PC system for rapid and reliable recording of stock levels, e.g. as part of a stocktake or goods inwards control
- **Item recognition using the optional barcode scanner is possible**, see accessories
- **Individual printout templates** can be stored for Weighing Mode and Counting Mode. Can be edited directly at the balance or at the PC
- **Note:** As well as stocktaking, the balance can be used in many other applications, e.g. as a weighing scale, commissioning balance or as a professional counting scale with item

memory for up to 500 items and associated daily totals memory for each item.

Technical data

Reference scale KB:

- Backlit LCD display, digit height 9 mm
- Weighing plate dimensions, stainless steel, Ø/WxD
KB 120-3N: Ø 81 mm
KB 1200-2N: 130x130 mm
- Dimensions housing WxDxH 167x250x85 mm
- Permissible ambient temperature 10 °C / 40 °C

Quantity scale FKA:

- Backlit and touch-sensitive LCD display with digit height 18 mm, screen diagonal 5.8" (approx. 147 mm)
- Dimensions housing WxDxH 350x390x120 mm
- Optional battery operation, 6 x 1.5 V Size C not included, operating time up to 15 h
- Permissible ambient temperature 10 °C / 40 °C

Accessories

Reference scale KB-N:

- **Protective working cover** over keyboard and housing, standard. Can be re-ordered, scope of delivery: 5 items, **€ 30,-**
KB 120-3N: KERN PCB-A02S05
KB 1200-2N: KERN PCB-A04S05
- **Rechargeable battery pack external**, operating time up to 15 hours with backlight, charging time approx. 10 h, KERN KB-A01N, **€ 50,-**

Reference scale FKA:

- **Barcode scanner**, table-top version, dimensions WxDxH 230x150x135 mm, KERN SMT-A02, **€ 685,-**
- **Barcode scanner**, hand-held version, dimensions WxDxH 235x210x115 mm, KERN SMT-A03, **€ 445,-**
- **Radio barcode scanner**, hand-held version, dimensions WxDxH 225x220x110 mm, KERN SMT-A04, **€ 495,-**
- Further accessory see page 96

STANDARD

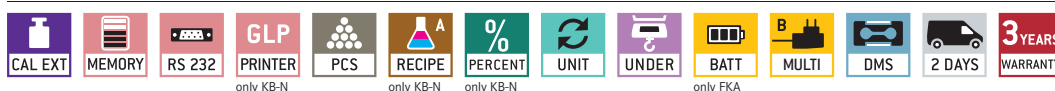

OPTION

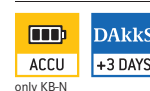

Model	Quantity scale	Weighing range [Max] kg	Readout [d] g	Weighing plate WxD mm	Reference scale	Weighing range [Max] g	Readout [d] g	Min. piece weight [Counting] g/piece	Price excl. of VAT ex works €	Option DAKKS Calibr. Certificate	
										DKD KERN	€
FKC 30K-6	FKA 30K-4	36	0,1	340 x 240	KB 120-3N	120	0,001	0,001	1280,-	962-128-127	145,-
FKC 30K-5	FKA 30K-4	36	0,1	340 x 240	KB 1200-2N	1200	0,01	0,01	1260,-	962-128-127	145,-
FKC 60K-6	FKA 60K-4	65	0,2	340 x 240	KB 120-3N	120	0,001	0,001	1280,-	962-129-127	160,-
FKC 60K-5	FKA 60K-4	65	0,2	340 x 240	KB 1200-2N	1200	0,01	0,01	1260,-	962-129-127	160,-



Quantity scale KERN KFP

Reference scale KERN CFS

Counting system to count the smallest parts in the largest quantities, counting resolution up to 999,999 points

Features

• This highly accurate counting system

KERN CCS can replace a whole range of individual counting scales, efficiently and at a reasonable price

Reference scale KERN CFS:

- This professional KERN CFS counting scale, which can also be used as a stand-alone scale, meets the highest demands for accuracy, weighing range and volume of items, by being connected to a high-capacity weighing bridge

• Programmable using numerical key pad:

- required reference quantity
- known reference weight
- **Memory (→PLU) for 100 items** with additional text
- **Fill-to-target function:** Programmable target weight. An acoustic and visual signal will be displayed when the target value is reached
- **Precise counting:** The automatic reference weight optimisation of reference weight gradually improves the average piece weight value
- For additional details on the KERN CFS reference scale, see page 91

Quantity scale KERN KFP:

- The high-accuracy quantity counting takes place on the weighing platform (= weighing bridge) KERN KFP
- **Stainless steel weighing plate**, painted steel base with **▲ - ■**
- **Aluminium singlepoint load cell** (1 x 3000 e), protection against dust and water splashes IP65
- For additional details on the KERN KFP quantity scale, see page 150

Counting system KERN CCS



Technical data

CFS:

- Large backlit LCD displays, digit height 20 mm
- Overall dimensions WxDxH 320x350x125 mm
- Weighing plate dimensions, stainless steel
 - CFS 300-3 Ø 80 mm
 - CFS 3K-5, CFS 6K0.1 WxD 294x225 mm
- Net weight approx. 3,3 kg

KFP/KFU:

- Weighing plate dimensions, stainless steel, WxDxH
 - A 230x230x110 mm
 - B 300x240x110 mm
 - C 400x300x128 mm
 - D 500x400x137 mm
 - E 650x500x142 mm
 - F 1000x1000x80 mm
 - G 1500x1250x80 mm
 - H 1500x1500x80 mm
 - 842x1300x90 mm

- Connection cable
 - A - E approx. 2,5 m
 - F - H approx. 5 m

Accessories

- **Reference scale** also available separately, for details, see page 91, KERN CFS 300-3, **€ 350,-**, KERN CFS 3K-5, **€ 300,-**, KERN CFS 6K0.1, **€ 270,-**
- **Protective working cover** over keyboard and housing standard. Can be re-ordered, scope of delivery: 5 items, for models with weighing plate size WxD 300x225 mm, KERN CFS-A02S05, **€ 40,-**
- **Rechargeable battery pack internal**, operating time up to 70 h without backlight, charging time approx. 14 h, not for models CFS 300-3, KERN GAB-A04, **€ 40,-**

Information on other high-capacity bulk balances, such as, for example, pallet scales, drive-through scales or floor scales is available on request, for information on other counting systems with the KERN CFS reference balance (d = 0.1 g), please refer to the website

- **Signal lamp** for visual support of weighing with tolerance range. Three-colour LED (yellow, green, red). Overall dimensions WxDxH 100x180x300 mm, for details, see page 181, KERN CFS-A03, **€ 250,-**
- **Y-cable** for parallel connection of two terminal devices to the RS-232 interface on the scale, e.g. signal lamp and printer, for details, see page 181, KERN CFS-A04, **€ 35,-**
- **Suitable printers** and further, extensive accessories from page 177

08

STANDARD



OPTION



Model	Quantity scale	Weighing range [Max] kg	Readout [d] g	Weighing plate	Reference scale	Weighing range [Max] g	Readout [d] g	Min. piece weight [Counting] g/piece	Price excl. of VAT ex works €	Option	
										DAKKS Calibr.	Certificate
KERN	KFP				CFS					DKD KERN	€
CCS 6K-6	KFP 6V20M	6	2	A	CFS 300-3	300	0,001	0,005	670,-	962-128-127	145,-
CCS 10K-6	KFP 15V20M	15	5	B	CFS 300-3	300	0,001	0,005	710,-	962-128-127	145,-
CCS 30K0.01.	KFP 30V20M	30	10	C	CFS 3K-5	3000	0,01	0,05	580,-	962-128-127	145,-
CCS 30K0.1.	KFP 30V20M	30	10	C	CFS 6K0.1	6000	0,1	0,1	570,-	962-128-128	175,-
CCS 60K0.01.	KFP 60V20M	60	20	C	CFS 3K-5	3000	0,01	0,05	580,-	962-129-127	160,-
CCS 60K0.01L.	KFP 60V20LM	60	20	D	CFS 3K-5	3000	0,01	0,05	660,-	962-129-127	160,-
CCS 60K0.1.	KFP 60V20M	60	20	C	CFS 6K0.1	6000	0,1	0,1	550,-	962-129-128	175,-
CCS 60K0.1L.	KFP 60V20LM	60	20	D	CFS 6K0.1	6000	0,1	0,1	610,-	962-129-128	175,-
CCS 150K0.01	KFP 150V20M	150	50	D	CFS 3K-5	3000	0,01	0,05	660,-	962-129-127	160,-
CCS 150K0.01L	KFP 150V20LM	150	50	E	CFS 3K-5	3000	0,01	0,05	890,-	962-129-127	160,-
CCS 150K0.1.	KFP 150V20M	150	50	D	CFS 6K0.1	6000	0,1	0,1	610,-	962-129-128	175,-
CCS 150K0.1L	KFP 150V20LM	150	50	E	CFS 6K0.1	6000	0,1	0,1	850,-	962-129-128	175,-
CCS 300K0.1	KFP 300V20M	300	100	E	CFS 6K0.1	6000	0,1	0,1	850,-	962-129-128	175,-
CCS 300K0.01	KFP 300V20M	300	100	E	CFS 3K-5	3000	0,01	0,05	890,-	962-129-127	160,-
CCS 600K-2	KFP 600V20SM	600	200	F	CFS 3K-5	3000	0,01	0,05	1450,-	962-130-127	237,-
CCS 600K-2L	KFP 600V20M	600	200	G	CFS 3K-5	3000	0,01	0,05	1850,-	962-130-127	237,-
CCS 600K-2U	KFP 600V20M	600	200	I	CFS 3K-5	3000	0,01	0,05	1350,-	962-130-127	237,-
CCS 1T-1	KFP 1500V20SM	1500	500	F	CFS 6K0.1	6000	0,1	0,1	1390,-	962-130-128	253,-
CCS 1T-1L	KFP 1500V20M	1500	500	G	CFS 6K0.1	6000	0,1	0,1	1890,-	962-130-128	253,-
CCS 1T-1U	KFU 1500V20M	1500	500	I	CFS 6K0.1	6000	0,1	0,1	1290,-	962-130-128	253,-
CCS 3T-1	KFP 3000V20M	3000	1000	G	CFS 6K0.1	6000	0,1	0,1	1950,-	962-132-128	528,-
CCS 3T-1L	KFP 3000V20LM	3000	1000	H	CFS 6K0.1	3000	0,01	0,1	2050,-	962-132-128	528,-



Quantity scale KERN KXP



Reference scale KERN ILT

08

Premium counting system for high-capacity counting applications with the highest level of accuracy, counting resolution up to 6 million points



Easy entering of item data using the connected barcode or RFID scanner



High level of connectivity

- 1 x Ethernet
- 2 x RS-232
- 2 x USB e.g. for data exchange or connecting barcode or RFID scanners
- 1 x WLAN
- Digital I/O (4 in/4 out) e.g. to control machines and plants
- 1 x Interface for additional display

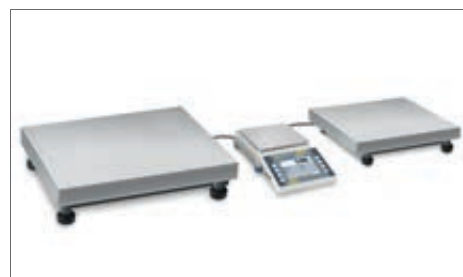

On the basis of the KERN ILT reference balance, you can put together a wide range of high-performance counting systems, for example, with an additional bulk balance, to cover more weighing ranges - your KERN product specialist will be pleased to advise you

Premium counting system KERN CCP

Features

- **This highly accurate counting system**
KERN CCP can replace a whole range of individual counting scales, efficiently and at a reasonable price
- **High level of connectivity:** Thanks to a range of integrated interfaces
- **Alibi memory:** Electronic archiving of weighing results, see also page 214
- **Data interface USB** for transferring weighing data to the PC, printer, USB sticks etc.
- **User-friendly batch management**
- **Individual print formats**

Reference scale KERN ILT:

- The counting system is operated using the KERN ILT touchscreen reference balance and offers the full range of functions for demanding counting applications
- This professional touchscreen platform scale KERN ILT which can also be used as a stand-alone scale, meets even the highest demands for accuracy, weighing range and volume of items (up to 6 millions items)
- **Intuitive operation using the touch display** increases efficiency and saves costs
- **Creation and recall items to be counted from the database (8 GB)** with all relevant additional data such as piece weight, name, price (for internal valuation), reference quantity, tare container weight, barcode, item image etc.
- **Fill-to-target function:** Programmable target weight. A visual signal will be displayed when the target value is reached
- **Precise counting:** The automatic reference weight optimisation gradually improves the average value of the piece weight
- For additional details on the KERN ILT reference scale, see page 120/121

Quantity scale KERN KXP/KFP:

- The high-accuracy quantity counting takes place on the weighing platform (= weighing bridge) KERN KXP/KFP. In this way even the smallest of parts can be counted in large volumes
- **Stainless steel weighing plate**, painted steel base, extremely resistant to bending, wing design, aluminium singlepoint load cell, 3000 e, protection against dust and water splashes IP65
- **KFP only:** Weighing bridge painted steel, extremely resistant to bending due to material thickness, four load cells, steel, 3000 e, dust and spray protection IP67
- For additional details on the KERN KXP quantity scale, see page 150, KERN KFP, see page 151

Technical data

ILT:

- **Backlit and touch-sensitive LCD display** with digit height 21 mm, screen diagonal 5,7" (approx. 145 mm)
- Weighing plate dimensions, stainless steel, WxDxH
ILT 6K-4BAM: 195x195 mm
ILT 6K-3GAM: 230x230 mm
ILT 10K-3GAM: 300x240 mm
- Connection cable approx. 3 m
- Permissible ambient temperature 15 °C / 35 °C

KXP V20 IP65/KFP V20 IP65:

- Weighing plate dimensions, WxDxH
A 300x240 mm, stainless steel
B 400x3000 mm, stainless steel
C 500x400 mm, stainless steel
D 1500x1250 mm, steel, lacquered
E 1500x1500 mm, steel, lacquered
- Permissible ambient temperature -10 °C / 40 °C

Accessoires

ILT:

- **Transponder card reader**, for additional details, see page 186, KERN KET-A05, € 450,-
- **Transponder card**, for additional details, see page 186, KERN KET-A08, € 65,-
- **RS-232 barcode scanner**, for additional details, see page 184, KERN PET-A05, € 350,-
- **USB barcode scanner**, for additional details, see page 184, KERN PET-A09, € 350,-
- **Wall mount** for display device, for additional details, see page 186, KERN KET-A02, € 190,-
- **Second display**, for additional details, see page 185, KERN KET-A03, € 210,-
- **Large display**, for additional details, see page 185, KERN KET-A06, € 1450,-
- **Direct thermal label printer**, for additional details, see page 184, KERN PET-A13, € 980,-
- **Thermal transfer and direct thermal label printer**, for additional details, see page 184, KERN PET-A14, € 1000,-
- **Software for database management**, for additional details, see page 184, KERN KET-A04, € 300,-
- **Suitable printers** and further, extensive accessories from page 177

STANDARD



STANDARD



OPTION

Model	Quantity scale	Weighing range [Max] kg	Weighing plate	Reference scale	Weighing range [Max] kg	Readout [d] g	Min. piece weight [Counting] g/piece	Price excl. of VAT ex works €	Option	
									DAKKS Calibr. Certificate	€
KERN CCP 10K-4	KXP 15V20M	15	A	ILT 6K-4BAM	6	0,1	0,1	2900,-	962-128-128	175,-
KERN CCP 30K-4	KXP 30V20M	30	B	ILT 6K-4BAM	6	0,1	0,1	3000,-	962-128-128	175,-
KERN CCP 60K-4	KXP 60V20M	60	B	ILT 6K-4BAM	6	0,1	0,1	2900,-	962-129-128	175,-
KERN CCP 60K-4L	KXP 60V20LM	60	C	ILT 6K-4BAM	6	0,1	0,1	3000,-	962-129-128	175,-
KERN CCP 100K-3	KXP 150V20M	150	C	ILT 10K-3GAM	6 15	2 5	0,1	2600,-	962-129-128	175,-
KERN CCP 600K-4	KXP 600V20M	600	D	ILT 6K-4BAM	6	0,1	0,1	4200,-	962-130-128	253,-
KERN CCP 600K-3	KXP 600V20M	600	D	ILT 6K-3GAM	3 6	1 2	0,1	3800,-	962-130-128	253,-
KERN CCP 3T-7	KXP 3000V20M	3000	D	ILT 6K-4BAM	6	0,1	1	3300,-	962-132-128	528,-
KERN CCP 3T-7L	KFP 3000V20LM	3000	E	ILT 6K-4BAM	6	0,1	2	3300,-	962-132-128	528,-



Reference scale KERN PLJ-C

Quantity scale KERN ILT

Premium counting system with EC type approval [M], for complex counting applications with the highest level of accuracy, counting resolution up to 6 million points

Features

- **This highly accurate counting system**
KERN CCT can replace a whole range of individual counting scales, efficiently and at a reasonable price
- Thanks to **EC type approval [M]** this counting system can also be used in verified applications, e.g. for order picking packaged items, etc.
- **Alibi Memory:** Paperless archiving of up to 100,000 weighing results For weighings where verification is mandatory, and which are to be analysed and processed by a PC, the legislative body requires electronic archiving using a verifiable, non-manipulatable data memory

- **High level of connectivity:** Thanks to a range of integrated interfaces
- **Data interface USB:** for transferring weighing data to the PC, printer, USB sticks etc.
- **Individual print formats:** Printouts can be individually adjusted depending on operating mode, application or your own requirements, directly at the balance or the PC

Reference scale KERN PLJ-C/AEJ-C:

- The highly accurate reference balances KERN PLJ-C and AEJ-C determine the piece weight of items to be counted with the highest level of precision

- These precision balances, which can also be used as individual balances, can fulfil even the highest level of requirements for accuracy, weighing range and volume of items (up to 6 million items) through connection to a high-capacity platform scale
- **Automatic internal adjustment** in the case of a change in temperature $\geq 3\text{ }^{\circ}\text{C}$ or time-controlled every 3 hours, guarantees high degree of accuracy
- **Internal memory** for up to 999 weighing results, 1000 items, 100 container weights, 100 users
- For additional details on the KERN PLJ-C reference scale, see page 33, KERN AEJ-CM, see page 48

Premium counting system KERN CCT

Quantity scale KERN ILT:

- The high-accuracy quantity counting takes place on the platform scale KERN ILT
- The counting system is operated using the premium display device of the KERN ILT bulk balance and offers the full range of functions for demanding counting applications
- **Intuitive operation using the touch display** increases efficiency and saves costs
- **Creation and recall items to be counted from the database (8 GB)** with all relevant additional data such as piece weight, name, price (for internal valuation), reference quantity, tare container weight, barcode, item image etc.
- **User-friendly batch management**
- **Fill-to-target function:** Programmable target weight. An acoustic and visual signal will be displayed when the target value is reached
- **Precise counting:** The automatic reference weight optimisation gradually improves the average value of the piece weight
- Thanks to its wide range of functions and large database, this touchscreen platform scale, which can also be used as individual scale, is particularly suitable for complex recipe or checkweighing applications, as well as classic counting and weighing applications
- For additional details on the KERN ILT quantity scale, see page 120/121

Technical data

PLJ-C:

- Backlit LCD display, digit height, 17 mm
- Weighing plate dimensions, stainless steel, WxD
PLJ 300-3CM, PLJ 600-3CM: 128x128 mm
PLJ 3000-2CM: 195x195 mm
- Connection cable approx. 15 m
- Total dimensions, WxDxH without draft shield 206x332x88 mm, draft shield incl. 206x332x170 mm
- Net weight approx. 3,6 kg (draft shield incl. approx. 4,7 kg)
- Permissible ambient temperature 15 °C/30 °C

AEJ-C:

- Backlit LCD display, digit height, 17 mm
- Weighing plate dimensions Ø 85 mm
- Total dimensions, WxDxH 206x335x335 mm
- Net weight approx. 5 kg
- Permissible ambient temperature 18 °C / 30 °C

ILT:

- Weighing plate dimensions, stainless steel, WxD
A 195x195 mm
B 300x240 mm
C 400x300 mm
D 500x400 mm
- Connection cable approx. 1,5 m
- Permissible ambient temperature 15 °C / 35 °C

Accessoires

PLJ-C:

- **WLAN interface** for wireless connection of the balance to networks and WLAN capable devices, such as tablets, laptops or Smartphones, can not be reordered, please ask for delivery time, KERN PLJ-A06, **€ 135,-**

ILT:

- **Transponder card reader**, for additional details, see page 186, KERN KET-A05, **€ 450,-**
- **Transponder card**, for additional details, see page 186, KERN KET-A08, **€ 65,-**
- **RS-232 barcode scanner**, for additional details, see page 184, KERN PET-A05, **€ 350,-**
- **USB barcode scanner**, for additional details, see page 184, KERN PET-A09, **€ 350,-**
- **USB keyboard**, for additional details, see page 185, KERN PET-A06, **€ 45,-**
- **Wall mount** for display device, for additional details, see page 186, KERN KET-A02, **€ 190,-**
- **Second display**, for additional details, see page 185, KERN KET-A03, **€ 210,-**
- **Large display**, for additional details, see page 185, KERN KET-A06, **€ 1450,-**
- **Analogue/Digital converter**, for additional details, see page 186, KERN KET-A01, **€ 350,-**
- **Direct thermal label printer**, for additional details, see page 184, KERN PET-A13, **€ 980,-**
- **Thermal transfer and direct thermal label printer**, for additional details, see page 184, KERN PET-A14, **€ 1000,-**
- **Software for database management**, for additional details, see page 184, KERN KET-A04, **€ 300,-**
- **PLJ-C only: Software for reading from the alibi memory in KERN balances**, for additional details, see page 179, KERN PET-A16, **€ 300,-**
- **Suitable printers** and further, extensive accessories from page 177

STANDARD

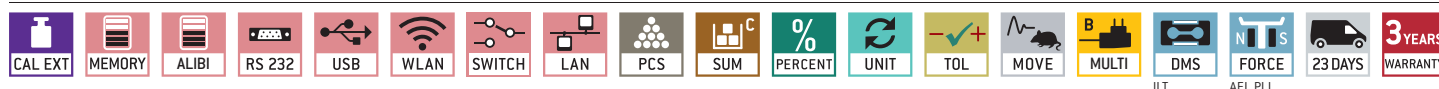

Model	Quantity scale	Weighing range [Max] kg	Weighing plate	Reference scale	Weighing range [Max] g	Readout [d] g	Min. piece weight [Counting] g/piece	Price excl. of VAT ex works €	Options			
									Verification		DAkkS Calibr. Certif.	
KERN	ILT			PLJ/AEJ				€	€	DKD KERN	€	
CCT 6K-6	ILT 6K-4BAM	6	A	PLJ 300-3CM	360	0,001	0,001	4 100,-	965-217-216	143,-	962-128-127	145,-
CCT 10K-6	ILT 10K-3GAM	6 15	B	PLJ 300-3CM	360	0,001	0,001	2 700,-	965-228-216	121,-	962-128-127	145,-
CCT 10K-7	ILT 10K-3GAM	6 15	B	AEJ 200-4CM	220	0,0001	0,0001	3 100,-	965-228-201	165,-	962-128-101	226,-
CCT 30K-5	ILT 30K-2GAM	15 30	C	PLJ 3000-2CM	3500	0,01	0,01	2 800,-	965-228-216	121,-	962-128-127	145,-
CCT 60K-6	ILT 60K-2GAM	30 60	C	PLJ 600-3CM	600	0,001	0,001	2 800,-	965-229-216	159,-	962-129-127	160,-
CCT 60K-5	ILT 60K-2GAM	30 60	C	PLJ 3000-2CM	3500	0,01	0,01	2 800,-	965-229-216	159,-	962-129-127	160,-
CCT 60K-5L	ILT 60K-2LGAM	30 60	D	PLJ 3000-2CM	3500	0,01	0,01	3 000,-	965-229-216	159,-	962-129-127	160,-
CCT 100K-5	ILT 100K-2GAM	60 150	D	PLJ 3000-2CM	3500	0,01	0,01	2 900,-	965-229-216	159,-	962-129-127	160,-
CCT 100K-5L	ILT 100K-2LGAM	60 150	D	PLJ 3000-2CM	3500	0,01	0,01	2 900,-	965-229-216	159,-	962-129-127	160,-
CCT 300K-5	ILT 300K-2GAM	150 300	D	PLJ 3000-2CM	3500	0,01	0,01	3 000,-	965-229-216	159,-	962-129-127	160,-

Note: For applications that require verification, please order verification at the same time, initial verification at a later date is not possible. Verification at the factory, we need to know the full address of the location of use.

Industrial scales

In the KERN range there are portable, affordable entry level models for weighing post or parcels, high-quality models with a high → **IP protection** and type approval (→ **Verification**) for commercial trade applications, up to top level models with touchscreen technology for complex recipe or check-weighing applications with relay control – there is the right platform scale for each application.

Platform scales benefits are obvious:

- Weighing range from 3 kg – 600 kg
- Robust platform construction for harsh industrial applications
- Versatile, available with stand
- High overload protection
- Stainless steel weighing plate, shock proof and easy to clean
- Display device can be positioned separately, e.g. wall-mounted, on a stand or next to the platform. This guarantees for an always clear view on the display despite bulky items on the scale
- Large selection of platform sizes



In order to meet the various requirements of our industrial customers, KERN platform scales have a large number of practical functions. From counting and recipe functions via → **data interfaces** (RS-232, RS-485, USB, Bluetooth, WLAN, Ethernet) for connecting scales to a network, PC or printer to the useful battery or rechargeable battery operation for mobile use. The „Hold function“ is particularly useful for industrial weighing and guarantees stable results even in turbulent locations or when weighing animals – a true all-rounder.

The newest development for an even greater level of user-friendliness is the wireless communication between platform and display device, giving the highest level of flexibility – weighing at the location of use of installation and read the weight up to 20 m away.

Particularly practical: the touchless tare function allows for taring the scale without having to touch it by using movement sensors. This is useful when working with gloves or dirty hands, see page 109, 120.

→ See the glossary on page 214 – 216

Your product specialist's recommendation:

-  **The bestseller in parcel scales**
-  **Enormous range of functions**
-  **Easy to use**

**Stephan Ade**

Product specialist Platform scales

Tel. +49 [0] 7433 9933-121

Fax +49 [0] 7433 9933-29121

ade@kern-sohn.com

HIGH-LIGHT

from €

185,-

▶ page 110

KERN DE-D

Quick-Finder Platform scales

Read-out	Weighing range	Weighing plate	Model	Price excl. of VAT ex works €	Page	DAYS	M	CAL INT	CAL EXT	MEMORY	RS 232	PCS	IP	BATT	ACCU
[d]	[Max]	mm	KERN				For an explanation on the pictos, see the front flap								
0,01 g	3 kg	228x228x90	DS 3K0.01S	640,-	114	1									
0,01 g	3 kg	228x228x70	IKT 3K0.01S	920,-	118	1									
0,01 g	10 kg	347x259	ILT 10K-5NM	3600,-	120	21	○	●							
0,05 g	5 kg	228x228x90	DS 5K0.05S	560,-	114	1									
0,05 g	8 kg	308x318x75	DS 8K0.05	550,-	114	1									
0,05 g	8 kg	318x308x75	IKT 8K0.05	850,-	118	1									
0,1 g	6 kg	318x308x75	IKT 6K0.1	830,-	118	1									
0,1 g	6 kg	195x195	ILT 6K-4BAM	2200,-	120	21	○	●							
0,1 g	10 kg	228x228x90	DS 10K0.1S	530,-	114	1									
0,1 g	10 kg	228x228x70	IKT 10K0.1S	850,-	118	1									
0,1 g	16 kg	308x318x75	DS 16K0.1	550,-	114	1									
0,1 g	16 kg	318x308x75	IKT 16K0.1	850,-	118	1									
0,1 g	20 kg	308x318x75	DS 20K0.1	580,-	114	1									
0,1 g	25 kg	347x259	ILJ 25K-4CM	2050,-	122	1	○	●							
0,1 g	30 kg	308x318x75	DS 30K0.1	610,-	114	1									
0,1 g	30 kg	450x350x115	DS 30K0.1L	700,-	114	1									
0,1 g	30 kg	318x308x75	IKT 30K0.1	850,-	118	1									
0,1 g	30 kg	450x350x115	IKT 30K0.1L	1150,-	118	1									
0,1 g	30 kg	347x259	ILS 30K-4C	1790,-	122	1									
0,1 g	35 kg	347x259	ILT 35K-4NM	4200,-	120	21	○	●							
0,1 g	50 kg	347x259	ILS 50K-4C	2320,-	122	1									
0,1 g	50 kg	347x259	ILT 50K-4C	5500,-	120	21									
0,2 g	6 kg	300x240x110	IFB 6K-4	320,-	112	1									
0,2 g	6 kg	300x240x86	IXS 6K-4	590,-	116	1						●			
0,2 g	12 kg	318x308x75	IKT 12K0.2	830,-	118	1									
0,2 g	36 kg	308x318x75	DS 36K0.2	550,-	114	1									
0,2 g	36 kg	318x308x75	IKT 36K0.2	850,-	118	1									
0,2 g	60 kg	450x350x115	DS 60K0.2	740,-	114	1									
0,2 g	60 kg	450x350x115	IKT 60K0.2L	1120,-	118	1									
0,2 0,5 g	6 15 kg	318x308x85	DE 15K0.2D	335,-	110	1						●		○	○
0,5 g	6 kg	318x308x75	DE 6K0.5A	215,-	110	1							●	○	○
0,5 g	15 kg	300x240x110	IFB 10K-4	320,-	112	1									
0,5 g	15 kg	300x240x86	IXS 10K-4	590,-	116	1						●			
0,5 g	15 kg	400x300x89	IXS 10K-4L	590,-	116	1						●			
0,5 g	30 kg	318x308x75	IKT 30K0.5	830,-	118	1									
0,5 g	65 kg	450x350x115	DS 65K0.5	700,-	114	1									
0,5 g	65 kg	450x350x115	IKT 65K0.5L	1050,-	118	1									
0,5 g	100 kg	450x350x115	DS 100K0.5	740,-	114	1									
0,5 g	100 kg	450x350x115	IKT 100K0.5L	1150,-	118	1									
0,5 1 g	15 35 kg	318x308x85	DE 35K0.5D	335,-	110	1						●		○	○
1 g	6 kg	318x308x75	IKT 6K1M	990,-	118	1	○								
1 g	12 kg	318x308x75	DE 12K1A	215,-	110	1							●	○	○
1 g	30 kg	400x300x128	IFB 30K-3	390,-	112	1									
1 g	30 kg	400x300x89	IXS 30K-3	590,-	116	1						●			
1 g	30 kg	500x400x123	IXS 30K-3L	720,-	116	1						●			
1 g	60 kg	450x350x115	IKT 60K1L	1050,-	118	1									
1 g	60 kg	500x400	ILT 60K-3BAM	2400,-	120	21	○	●							
1 g	65 kg	450x350x115	DS 65K1M	790,-	114	1	○								
1 g	150 kg	450x350x115	DS 150K1	740,-	114	1									
1 g	150 kg	450x350x115	IKT 150K1L	1150,-	118	1									
1 2 g	3 6 kg	318x308x75	DE 6K1D	185,-	110	1							●	○	○
1 2 g	3 6 kg	300x240x110	IFB 6K1DM	320,-	112	1	○								
1 2 g	3 6 kg	300x240x86	IXS 6K-3M	500,-	116	1	○						●		
1 2 g	3 6 kg	230x230	ILT 6K-3GAM	2200,-	120	21	○	●							
1 2 g	30 60 kg	318x308x85	DE 60K1D	335,-	110	1							●	○	○
2 g	6 kg	300x240x110	SFE 6K-3M	380,-	115	1	○						●		
2 g	12 kg	318x308x75	IKT 12K2M	990,-	118	1	○								
2 g	24 kg	318x308x75	DE 24K2A	215,-	110	1							●	○	○
2 g	60 kg	400x300x128	IFB 60K-3	390,-	112	1									
2 g	60 kg	400x300x89	IXS 60K-3	590,-	116	1							●		
2 g	60 kg	500x400x123	IXS 60K-3L	720,-	116	1							●		
2 g	120 kg	450x350x115	IKT 120K2L	1050,-	118	1									
2 g	150 kg	650x500x142	IKT 150K2XL	1200,-	118	1									
2 5 g	6 15 kg	318x308x75	DE 15K2D	185,-	110	1							●	○	○
2 5 g	6 15 kg	300x240x110	IFB 15K2DM	320,-	112	1	○								
2 5 g	6 15 kg	300x240x86	IXS 10K-3M	500,-	116	1	○						●		
2 5 g	6 15 kg	300x240	ILT 10K-3GAM	1900,-	120	21	○	●							
2 5 g	60 150 kg	318x308x85	DE 150K2D	340,-	110	1							●	○	○
5 g	15 kg	315x305x30	EOA 10K-3	110,-	107	1									
5 g	15 kg	315x305x65	EOE 10K-3	130,-	107	1									
5 g	15 kg	315x305x65	EOB 15K5	152,-	108	1									











■ = News 2016

*For an explanation on the pictos, see the front flap

● = Standard

○ = Option

Quick-Finder Platform scales

Read-out	Weighing range	Weighing plate	Model	Price excl. of VAT ex works €	Page	 DAYS*									
[d]	[Max]	mm	KERN				For an explanation on the pictos, see the front flap								
5 g	15 kg	300x240x110	SFE 15K5IPM	360,-	115	1	○		●				●		●
5 g	15 kg	400x300x128	SFE 10K-3LM	420,-	115	1	○		●				●		●
5 g	30 kg	318x308x75	IKT 30K5M	1010,-	118	1	○		●						○
5 g	60 kg	318x308x75	DE 60K5A	215,-	110	1			●				●	○	○
5 g	150 kg	500x400x137	IFB 100K-3	490,-	112	1			●						○
5 g	300 kg	650x500x142	IKT 300K5XL	1200,-	118	1			●						○
5 10 g	15 30 kg	400x300x128	IFB 30K5DM	380,-	112	1	○		●						○
5 10 g	15 30 kg	400x300x89	IXS 30K-2M	590,-	116	1	○		●				●		○
5 10 g	15 30 kg	500x400x123	IXS 30K-2LM	720,-	116	1	○		●				●		○
5 10 g	15 30 kg	400x300	ILT 30K-2GAM	2200,-	120	21	○	●							
5 10 g	15 35 kg	318x308x75	DE 35K5D	185,-	110	1			●				●	○	○
5 10 g	15 35 kg	522x403x90	DE 35K5DL	315,-	110	1			●				●	○	○
5 10 g	150 300 kg	522x406x100	DE 300K5DL	435,-	110	1			●				●	○	○
10 g	30 kg	300x240x110	SFE 30K10IPM	360,-	115	1	○		●				●		●
10 g	35 kg	315x305x30	EOA 30K-2	110,-	107	1			●						○
10 g	35 kg	315x305x65	EOE 30K-2	130,-	107	1			●						○
10 g	35 kg	315x305x65	EOB 35K10	152,-	108	1			●						○
10 g	35 kg	315x305x65	EOB 35K-2F	205,-	109	1			●						○
10 g	60 kg	450x350x115	IKT 60K10LM	1250,-	118	1	○		●						○
10 g	120 kg	318x308x75	DE 120K10A	215,-	110	1			●				●	○	○
10 g	300 kg	650x500x142	IFB 300K-2	690,-	112	1			●						○
10 20 g	30 60 kg	318x308x75	DE 60K10D	185,-	110	1			●				●	○	○
10 20 g	30 60 kg	522x403x90	DE 60K10DL	315,-	110	1			●				●	○	○
10 20 g	30 60 kg	400x300x128	IFB 60K10DM	380,-	112	1	○		●						○
10 20 g	30 60 kg	500x400x137	IFB 60K10DLM	470,-	112	1	○		●						○
10 20 g	30 60 kg	400x300x89	IXS 60K-2M	590,-	116	1	○		●				●		○
10 20 g	30 60 kg	500x400x123	IXS 60K-2LM	720,-	116	1	○		●				●		○
10 20 g	30 60 kg	400x300	ILT 60K-2GAM	2200,-	120	21	○	●							
20 g	60 kg	315x305x30	EOA 50K-2	110,-	107	1			●						○
20 g	60 kg	315x305x65	EOE 60K-2	130,-	107	1			●						○
20 g	60 kg	315x305x65	EOB 60K20	152,-	108	1			●						○
20 g	60 kg	315x305x65	EOB 60K-2F	205,-	109	1			●						○
20 g	60 kg	550x550x65	EOB 60K20L	350,-	108	1			●						○
20 g	60 kg	400x300x128	SFE 60K20IPM	410,-	115	1	○		●				●		●
20 g	60 kg	500x400x137	SFE 60K-2LM	520,-	115	1	○		●				●		●
20 g	120 kg	450x350x115	IKT 120K20LM	1250,-	118	1	○		●						○
20 g	600 kg	800x600x150	IFB 600K-2	750,-	112	1			●						○
20 50 g	60 150 kg	318x308x75	DE 150K20D	195,-	110	1			●				●	○	○
20 50 g	60 150 kg	522x403x90	DE 150K20DL	315,-	110	1			●				●	○	○
20 50 g	60 150 kg	500x400x137	IFB 150K20DM	470,-	112	1	○		●						○
20 50 g	60 150 kg	650x500x142	IFB 150K20DLM	620,-	112	1	○		●						○
20 50 g	60 150 kg	500x400x123	IXS 100K-2M	720,-	116	1	○		●				●		○
20 50 g	60 150 kg	650x500x133,5	IXS 100K-2LM	790,-	116	1	○		●				●		○
20 50 g	60 150 kg	500x400	ILT 100K-2GAM	2100,-	120	21	○	●							
50 g	150 kg	315x305x30	EOA 100K-2	110,-	107	1			●						○
50 g	150 kg	315x305x65	EOE 100K-2	130,-	107	1			●						○
50 g	150 kg	315x305x65	EOB 150K50	152,-	108	1			●						○
50 g	150 kg	315x305x65	EOB 150K-2F	205,-	109	1			●						○
50 g	150 kg	505x505x65	EOE 150K50L	255,-	107	1			●						○
50 g	150 kg	945x505x65	EOE 150K50XL	300,-	107	1			●						○
50 g	150 kg	550x550x65	EOB 150K50L	350,-	108	1			●						○
50 g	150 kg	945x505x65	EOB 150K50XL	380,-	108	1			●						○
50 g	150 kg	900x550x60	EOS 150K50XL	410,-	108	1			●						○
50 g	150 kg	400x300x128	SFE 100K-2M	420,-	115	1	○		●				●		●
50 g	150 kg	900x550x60	EOS 150K50XLF	480,-	109	1			●						○
50 g	150 kg	500x400x137	SFE 100K-2LM	520,-	115	1	○		●				●		●
50 100 g	150 300 kg	522x403x90	DE 300K50D	315,-	110	1			●				●	○	○
50 100 g	150 300 kg	650x500x105	DE 300K50DL	380,-	110	1			●				●	○	○
50 100 g	150 300 kg	650x500x142	IFB 300K50DM	625,-	112	1	○		●						○
50 100 g	150 300 kg	650x500x133,5	IXS 300K-2M	790,-	116	1	○		●				●		○
50 100 g	150 300 kg	650x500	ILT 300K-2GAM	2200,-	120	21	○	●							
100 g	300 kg	315x305x65	EOB 300K100A	152,-	108	1			●						○
100 g	300 kg	505x505x65	EOE 300K100L	255,-	107	1			●						○
100 g	300 kg	945x505x65	EOE 300K100XL	300,-	107	1			●						○
100 g	300 kg	550x550x65	EOB 300K100L	350,-	108	1			●						○
100 g	300 kg	945x505x65	EOB 300K100XL	375,-	108	1			●						○
100 g	300 kg	900x550x60	EOS 300K100XL	410,-	108	1			●						○
100 g	300 kg	550x550x65	EOB 300K-1LF	420,-	109	1			●						○
100 g	300 kg	900x550x60	EOS 300K100XLF	480,-	109	1			●						○
100 g	300 kg	650x500x142	SFE 300K-1LM	720,-	115	1	○		●				●		●
100 200 kg	300 600 kg	800x600x150	IFB 600K-1M	890,-	112	1	○		●						○

■ = News 2016

*For an explanation on the pictos, see the front flap

● = Standard

○ = Option

Parcel scales KERN EOA · EOE



KERN EOA



KERN EOE

Parcel scales for fast and easy weighing in the office, production, dispatch etc.

Features

- **High mobility:** Battery operation, compact, flat construction and low weight make this scale ideal for the use in several locations
- Weighing plate steel, lacquered

EOA:

- **Simple and convenient 2-key operation**
- **Adjusting program CAL**, external test weights at an additional price, see page 189 ff.

EOE:

- **Wall mount** for display device standard
- **Hold function:** When the weighing conditions are unstable, a stable weight is calculated determining an average value

Technical data

- Large LCDdisplay, digit height 25 mm
- Permissible ambient temperature 10 °C / 35 °C
- Ready for use: Batteries included, 9 V block (EOA)/6 x 1.5 V AA (EOE), operating time up to 60 h

EOA:

- Dimensions of display device WxDxH 226x55x111 mm

EOE:

- Dimensions of display device WxDxH 210x110x45 mm

Accessories

EOA:

- **Protective working cover** over the display device, standard. Can be re-ordered, scope of delivery: 5 items, KERN DE-A12S05, € 30,-
- **External universal mains adapter**, with universal input and optional input socket adapters for EU, GB, USA. Not included, can be retrofitted, KERN YKA-06, € 35,-

EOE:

- **Ascending ramp** incl. pair of base plates for models with weighing plate size WxDxH 505x505x65 mm, not included. WxDxH 505x507x61 mm, can be retrofitted, KERN EOE-A02, € 135,-
- **Non-slip rubber mat**, WxD 945x505 mm, KERN EOE-A01, € 45,-
- **Sturdy transport case**, for models with weighing plate size ≤ 315x305x65 mm, for details see page 184, KERN MPS-A07, € 115,-

STANDARD

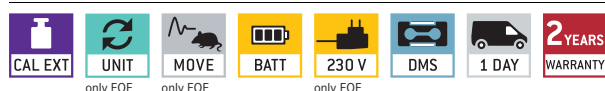

OPTION



Model	Weighing range [Max] kg	Readout [d] g	Reproducibility g	Linearity g	Net weight approx. kg	Cable length approx. m	Weighing plate mm	Price excl. of VAT ex works €	Option DAKkS Calibr. Certificate	
									DKD KERN	€
KERN EOA 10K-3	15	5	5	± 25	3	1,4	315x305x30	110,-	963-128	88,-
EOA 30K-2	35	10	10	± 50	3	1,4	315x305x30	110,-	963-128	88,-
EOA 50K-2	60	20	20	± 100	3	1,4	315x305x30	110,-	963-129	105,-
EOA 100K-2	150	50	50	± 250	3	1,4	315x305x30	110,-	963-129	105,-
KERN EOE 10K-3	15	5	5	± 10	4	1,8	315x305x65	130,-	963-128	88,-
EOE 30K-2	35	10	10	± 20	4	1,8	315x305x65	130,-	963-128	88,-
EOE 60K-2	60	20	20	± 40	4	1,8	315x305x65	130,-	963-129	105,-
EOE 100K-2	150	50	50	± 100	4	1,8	315x305x65	130,-	963-129	105,-
EOE 150K50L	150	50	50	± 100	12,5	2,7	505x505x65	255,-	963-129	105,-
EOE 150K50XL	150	50	50	± 100	19,5	2,7	945x505x65	300,-	963-129	105,-
EOE 300K100L	300	100	100	± 200	12,5	2,7	505x505x65	255,-	963-129	105,-
EOE 300K100XL	300	100	100	± 200	19,5	2,7	945x505x65	300,-	963-129	105,-

Parcel scales KERN EOB · EOS



KERN EOB



KERN EOS

The bestsellers in parcel- and veterinary scales, also with XL-platform, and big weighing ranges

Features

- **Stainless steel weighing plate**, painted steel base
- **Simple and convenient 4-key operation**
- **Wall mount** for display device, standard
- **Hold function:** When the weighing conditions are unstable, a stable weight is calculated determining an average value

EOS:

- The scale can be easily transported using 2 rollers and a handle and does not require much storage space

Technical data

- Large LCD display, digit height 25 mm
- Dimensions of display device WxDxH 210x110x45 mm

- Cable length of display device approx. 1,8 m
- Optional battery operation, 6 x 1.5 V AA not included, operating time up to 60 h
- Permissible ambient temperature 10 °C / 35 °C

EOB:

- Weighing plate dimensions, WxDxH
 - A** 315x305x65 mm
 - B** 550x550x65 mm, see enlarged picture
 - C** 945x505x65 mm

EOS:

- Weighing plate dimensions, stainless steel, WxDxH
 - D** 900x550x60 mm

Accessories

- **1 Stand** to elevate display device, height of stand approx. 950 mm, can be retrofitted, KERN MWS-A01, € 180,-

EOB:

- **Non-slip rubber mat**, only for models with weighing plate size **C**, KERN EOE-A01, € 45,-
- **2 Stand** to elevate display device, height of stand approx. 450 mm, only for models with weighing plate size **A**, can be retrofitted, KERN EOB-A01N, € 80,-

EOS:

- **Non-slip rubber mat** standard. Can be re-ordered, KERN EOS-A01, € 35,-

STANDARD



OPTION



Model	Weighing range [Max] kg	Readout [d] g	Reproducibility g	Linearity g	Net weight approx. kg	Weighing plate	Price excl. of VAT ex works €	Option DAKKS Calibr. Certificate	
								DKD KERN	€
KERN									
EOB 15K5	15	5	5	± 10	4,8	A	152,-	963-128	88,-
EOB 35K10	35	10	10	± 20	4,8	A	152,-	963-128	88,-
EOB 60K20	60	20	20	± 40	4,8	A	152,-	963-129	105,-
EOB 60K20L	60	20	20	± 40	14	B	350,-	963-129	105,-
EOB 150K50	150	50	50	± 100	4,8	A	152,-	963-129	105,-
EOB 150K50L	150	50	50	± 100	14	B	350,-	963-129	105,-
EOB 150K50XL	150	50	50	± 100	19	C	380,-	963-129	105,-
EOB 300K100A	300	100	100	± 200	4,8	A	152,-	963-129	105,-
EOB 300K100L	300	100	100	± 200	14	B	350,-	963-129	105,-
EOB 300K100XL	300	100	100	± 200	19	C	375,-	963-129	105,-
EOS 150K50XL	150	50	50	± 100	20,1	D	410,-	963-129	105,-
EOS 300K100XL	300	100	100	± 200	20,1	D	410,-	963-129	105,-

Parcel scales KERN EOB-F · EOS-F

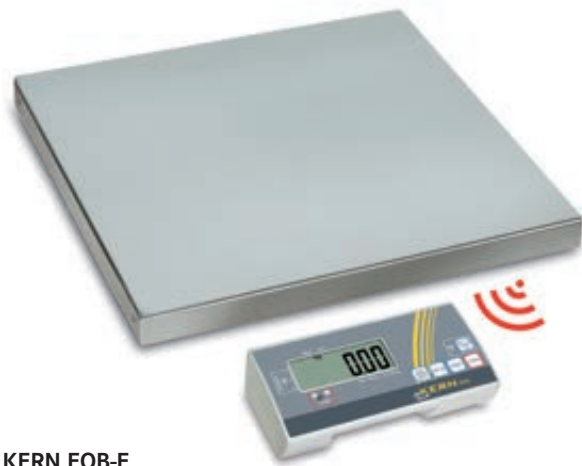

KERN EOB-F



KERN EOS-F

Radio platform scales with touchless tare function

Features

- **Display device with integrated radio module** for wireless communication with the weighing platform: ideal for weighing contaminated items, weighing in loud environments or with physical separation. Range approx. 20 m
- **Touchless tare function:** by the wave of your hand. No need to operate the scale with dirty gloves anymore
- **Network operation:** 3 frequencies for parallel use of several weighing platforms with a single display device
- **High mobility** thanks to battery operation for display device and platform
- **Simple and convenient 4-key operation**
- **Stainless steel weighing plate**, painted steel base
- **Wall mount** for display device standard
- **Hold function:** When the weighing conditions are unstable, a stable weight is calculated determining an average value

EOS -F:

- **2 rollers and handle** for easy transport of the scale

Technical data

- Large LCD display, digit height 25 mm
- Weighing plate dimensions, stainless steel, WxDxH
 - ▣ A 315x305x55 mm
 - ▣ B 550x550x65 mm
 - ▣ C 900x550x60 mm
- Dimensions of display device WxDxH 210x110x45 mm
- Optional battery operation, 6 x 1.5 V AA not included, operating time up to 70 h
- Permissible ambient temperature 10 °C / 35 °C

Accessories

- **Protective working cover** over keyboard and housing, standard. Can be re-ordered, scope of delivery: 5 items, KERN EOB-A02S05, **€ 46,-**
- **Stand** to elevate display device, height of stand approx. 450 mm, only for models with weighing plate size **A**, can be retrofitted, KERN EOB-A01N, **€ 80,-**
- **Stand** to elevate display device, can be retrofitted, height of stand approx. 950 mm, KERN MWS-A01, **€ 180,-**

EOS -F:

- **Non-slip rubber mat** standard. Can be re-ordered, KERN EOS-A01, **€ 35,-**

STANDARD



OPTION

Model	Weighing range [Max] kg	Readout [d] g	Reproducibility g	Linearity g	Weighing plate	Price excl. of VAT ex works €	Option DAkkS Calibr. Certificate	
							DKD KERN	€
KERN								
EOB 35K-2F	35	10	10	± 20	A	205,-	963-128	88,-
EOB 60K-2F	60	20	20	± 40	A	205,-	963-129	105,-
EOB 60K-2LF	60	20	20	± 40	B	410,-	963-129	105,-
EOB 150K-2F	150	50	50	± 100	A	205,- [Ⓢ]	963-129	105,-
EOB 150K-2LF	150	50	50	± 100	B	415,-	963-129	105,-
EOB 300K-1LF	300	100	100	± 200	B	420,-	963-129	105,-
EOS 150K50XLF	150	50	50	± 100	C	480,-	963-129	105,-
EOS 300K100XLF	300	100	100	± 200	C	480,-	963-129	105,-

[Ⓢ] Price reduction

For more information, please visit kern-sohn.com/en/EOB-F.../EOS-F · Order hotline +49 [0] 7433 9933-0



09

The long lasting story of success with dust and spray protected display device



Piece counting



Animal weighing

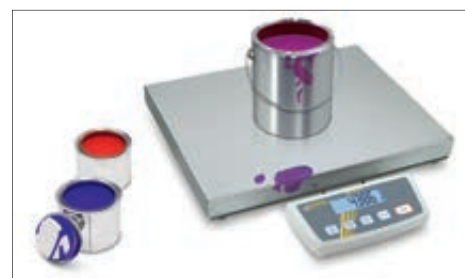

Recipe weighing

Features

- **High mobility:** Battery or rechargeable battery (optional) operation, compact and flat construction and low weight make this scale ideal for use in several locations (production, warehouse, dispatch department etc.)
- **Flexible positioning of display device:** e.g. free-standing or mounted to the wall (optional)

- **Display device IP65.** Protected against dust and spray (only when using battery or rechargeable battery pack)
- **Stainless steel weighing plate,** painted steel base
- **PRE-TARE function** for manual subtraction of a known container weight, useful for checking fill-levels

- With the **recipe function** you can weigh the different ingredients of a mixture. As a check, you can also call up the total weight of all the ingredients
- **Freely programmable weighing unit,** e.g. display direct in special units such as length of thread g/m, paper weight g/m², or similar

Parcel scale KERN DE-D



Technical data

- Large backlit LCD display, digit height 25 mm
- Weighing plate dimensions, stainless steel, WxDxH
 - A** 318x308x75 mm
 - B** 318x308x85 mm
 - C** 522x406x58 mm
 - D** 523x405x85 mm, see enlarged picture
 - E** 650x500x95 mm
- Dimensions of display device WxDxH 225x110x55 mm
- Optional battery operation, 9 V block, not included
- Permissible ambient temperature 5 °C / 35 °C

Accessories

- **Protective working cover** over the display device, standard. Can be re-ordered, scope of delivery: 5 items, KERN DE-A12S05, **€ 30,-**
- **Rechargeable battery pack internal**, operating time up to 15 h, charging time approx. 10 h, can be retrofitted, KERN NDE-A02, **€ 40,-**
- **Mount** to fasten the display device to the platform, can be retrofitted, KERN DE-A11N, **€ 35,-**
- **Wall mount** for display device, can be retrofitted, KERN DE-A13, **€ 30,-**

- **2 Stand** to elevate display device, height of stand approx. 480 mm, can be retrofitted, KERN DE-A10, **€ 95,-**
- **Individual header data:** the free software KERN SHM-01 can be used to set up 4 header lines on the printout for printers YKN-01 and YKB-01N
- **Suitable printers** and further, extensive accessories from page 177 ff.

STANDARD



OPTION



1

Model KERN	Weighing range [Max] kg	Readout [d] g	Reproducibility g	Linearity g	Min. piece weight [Counting] g/piece	Cable length approx. m	Net weight approx. kg	Weighing plate	Price excl. of VAT ex works €	Option	
										DAkKS KERN	Calibr. Certificate €
Dual-range balance switches automatically to the next largest weighing range [Max] and readout [d].											
DE 6K1D	3 6	1 2	1 2	± 3 ± 6	4	1,4	4	A	185,-	963-128	88,-
DE 15K2D	6 15	2 5	2 5	± 6 ± 15	10	1,4	4	A	185,-	963-128	88,-
DE 35K5D	15 35	5 10	5 10	± 15 ± 30	10	1,4	4	A	185,-	963-128	88,-
DE 35K5DL	15 35	5 10	5 10	± 15 ± 30	10	1,4	16	D	315,-	963-128	88,-
DE 60K10D	30 60	10 20	10 20	± 30 ± 60	20	1,4	4	A	185,-	963-129	105,-
DE 60K10DL	30 60	10 20	10 20	± 30 ± 60	20	1,4	16	D	315,-	963-129	105,-
DE 150K20D	60 150	20 50	20 50	± 60 ± 150	40	1,4	4	A	195,-	963-129	105,-
DE 150K20DL	60 150	20 50	20 50	± 60 ± 150	40	1,4	16	D	315,-	963-129	105,-
DE 150K20DXL	60 150	20 50	20 50	± 60 ± 150	40	1,4	28	E	380,-	963-129	105,-
DE 300K50D	150 300	50 100	50 100	± 150 ± 300	200	1,4	16	D	315,-	963-129	105,-
DE 300K50DL	150 300	50 100	50 100	± 150 ± 300	200	1,4	28	E	380,-	963-129	105,-
Dual-range balance with high-resolution display											
DE 6K0.5A	6	0,5	0,5	± 1,5	1	1,4	4	A	215,-	963-128	88,-
DE 12K1A	12	1	1	± 3	2	1,4	4	A	215,-	963-128	88,-
DE 24K2A	24	2	2	± 6	4	1,4	4	A	215,-	963-128	88,-
DE 60K5A	60	5	5	± 15	10	1,4	4	A	215,-	963-129	105,-
DE 120K10A	120	10	10	± 30	20	1,4	4	A	215,-	963-129	105,-
DE 15K0.2D	6 15	0,2 0,5	0,2 0,5	± 0,8 ± 2	0,4	1	4	B	335,-	963-128	88,-
DE 35K0.5D	15 35	0,5 1	0,5 1	± 2 ± 4	1	1	4	B	335,-	963-128	88,-
DE 60K1D	30 60	1 2	1 2	± 4 ± 8	2	1	4	B	335,-	963-129	105,-
DE 60K1DL	30 60	1 2	1 2	± 4 ± 8	2	1,4	16	C	435,-	963-129	105,-
DE 150K2D	60 150	2 5	2 5	± 8 ± 20	4	1	4	B	340,-	963-129	105,-
DE 150K2DL	60 150	2 5	2 5	± 8 ± 20	4	1,4	16	C	435,-	963-129	105,-
DE 300K5DL	150 300	5 10	5 10	± 20 ± 40	10	1,4	16	C	435,-	963-129	105,-



Platform scale in heavy version with EC type approval [M], now also up to [Max] 600 kg

Features

- **Industrial quality:** because of its stable construction and robust design, it is ideal for continuous use in an industrial environment
- **Platform:** Weighing plate stainless steel, painted steel base, protection against dust and water splashes IP65, silicone-coated aluminium load cell, details see page 150
- **Display device:** Superior display size, digit height 52 mm for the easy reading of weighing results, even under poor lighting conditions. For details see page 147, KERN KFB-TM
- **Benchtop stand incl. wall mount** for display device as standard
- **Level indicator and levelling feet** for precise levelling of the scale, fitted as standard, to give the most accurate weighing results
- **Weighing with tolerance range (checkweighing):** Input of an upper/lower limit value. A visual and audible signal assists with portioning, dispensing or grading
- **Totalising** of weights and piece counts
- **Hold function:** When the weighing conditions are unstable, a stable weight is calculated determining an average value
- **New:** high-resolution models for high-precision weighing and models with a weighing range of 600 kg!

Industrial platform scale KERN IFB



Technical data

- Large backlit LCD display, digit height 52 mm
- Weighing plate dimensions, stainless steel, WxDxH
 - A 300x240x110 mm
 - B 400x300x115 mm
 - C 500x400x137 mm, see enlarged picture
 - D 650x500x142 mm
 - E 800x600x200 mm
- Cable length of display device approx. 3 m
- Permissible ambient temperature -10 °C / 40 °C

Accessories

- **Protective working cover** over the display device standard. Can be re-ordered, scope of delivery: 5 items, KERN KFB-A02S05, **€ 35,-**
- **Signal lamp** for visual support of weighing with tolerance range. For details see page 181, can be retrofitted, KERN CFS-A03, **€ 250,-**
- **Stand** to elevate display device,
 - 1 height of stand approx. 330 mm, see illustration, KERN IFB-A01, **€ 50,-**
 - height of stand approx. 600 mm, can be retrofitted, for models with weighing plate size C, D and E, KERN IFB-A02, **€ 60,-**
 - height of stand approx. 750 mm, can be retrofitted, KERN BFS-A07, **€ 120,-**

- **Y-cable**, RS-232, details see page 181, can be retrofitted, KERN CFS-A04, **€ 35,-**
- **Rechargeable battery pack internal**, operating time up to 35 h, charging time approx. 12 h, must be ordered at purchase, KERN KFB-A01, **€ 35,-**
- **Large display with superior display size**, for details see page 181, can be retrofitted, KERN YKD-A02, **€ 215,-**
- **Suitable printers** and further, extensive accessories from page 177 ff.

STANDARD



OPTION



FACTORY



Model	Weighing range [Max] kg	Readout [d] g	Verification value [e] g	Minimum load [Min] g	Net weight approx. kg	Weighing plate	Price excl. of VAT ex works €	Options			
								Verification		DAkKS Calibr. Certificate	
								M KERN	€	DKD KERN	€
IFB 6K-4	6	0,2	-	-	6	A	320,-	-	-	963-128	88,-
IFB 10K-4	15	0,5	-	-	6	A	320,-	-	-	963-128	88,-
IFB 10K-4L	15	0,5	-	-	10	B	390,-	-	-	963-128	88,-
IFB 30K-3	30	1	-	-	10	B	390,-	-	-	963-128	88,-
IFB 60K-3	60	2	-	-	10	B	390,-	-	-	963-129	105,-
IFB 60K-3L	60	2	-	-	13	C	490,-	-	-	963-129	105,-
IFB 100K-3	150	5	-	-	13	C	490,-	-	-	963-129	105,-
IFB 100K-3L	150	5	-	-	22	D	690,-	-	-	963-129	105,-
IFB 300K-2	300	10	-	-	22	D	690,-	-	-	963-129	105,-
IFB 600K-2	600	20	-	-	51	E	750,-	-	-	963-130	165,-
Dual-range balance switches automatically to the next largest weighing range [Max] and readout [d].											
IFB 6K1DM	3 6	1 2	1 2	20	6	A	320,-	965-228	55,-	963-128	88,-
IFB 15K2DM	6 15	2 5	2 5	40	6	A	320,-	965-228	55,-	963-128	88,-
IFB 15K2DLM	6 15	2 5	2 5	40	10	B	380,-	965-228	55,-	963-128	88,-
IFB 30K5DM	15 30	5 10	5 10	100	10	B	380,-	965-229	93,-	963-129	105,-
IFB 60K10DM	30 60	10 20	10 20	200	10	B	380,-	965-229	93,-	963-129	105,-
IFB 60K10DLM	30 60	10 20	10 20	200	13	C	470,-	965-229	93,-	963-129	105,-
IFB 150K20DM	60 150	20 50	20 50	400	13	C	470,-	965-229	93,-	963-129	105,-
IFB 150K20DLM	60 150	20 50	20 50	400	22	D	620,-	965-229	93,-	963-129	105,-
IFB 300K50DM	150 300	50 100	50 100	1000	22	D	625,-	965-229	93,-	963-129	105,-
IFB 600K-1M	300 600	100 200	100 200	2000	51	E	890,-	965-230	132,-	963-130	165,-

Note: For applications that require verification, please order verification at the same time, initial verification at a later date is not possible. Verification at the factory, we need to know the full address of the location of use.

Precision platform scales KERN DS · DS-M

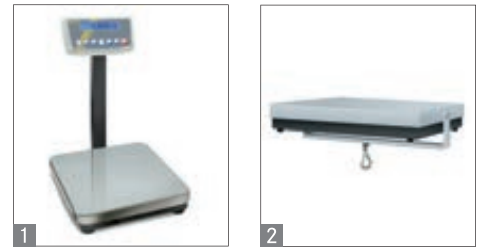

- Cable length of display device
A, B approx. 2 m
C approx. 0,6 m
- Permissible ambient temperature DS:
 10 °C / 40 °C; DS-M: 10 °C / 30 °C

Accessories

- **Protective working cover** over the display device, standard. Can be re-ordered, scope of delivery: 5 items, KERN DE-A12S05, **€ 30,-**
- **1 Stand** to elevate display device, for models with weighing plate size **B, C**, height of stand approx. 480 mm, can be retrofitted, KERN DE-A10, **€ 95,-**
- **Mount** to fasten the display device to the platform, for models with weighing plate size **B, C**, can be retrofitted, KERN DE-A11N, **€ 35,-**
- **Wall mount** for display device, can be re-ordered, KERN DS-A02, **€ 30,-**
- **2 Set for underfloor weighing**, for models with weighing plate size **B**, can be retrofitted, KERN DS-A01, **€ 200,-**
- **Rechargeable battery pack external**, operating time up to 25 hours with backlight, charging time approx. 10 h, can be retrofitted, KERN KS-A01, **€ 180,-**
- **Rechargeable battery pack internal**, operating time up to 10 hours with backlight, charging time approx. 10 h, can be retrofitted, KERN KB-A01N, **€ 50,-**
- **Suitable printers** and further, extensive accessories from page 177 ff.

Precision industrial scale with laboratory accuracy, also with EC type approval [M] class II

Features

- **High-capacity precision balance**, ideal for high volume or heavy samples to be weighed with a high degree of accuracy
- **User guidance step by step** on display by Yes/No dialogue
- **Numerical subtraction of tare weight** for known container weight. Useful for checking fill-levels
- **Precise counting**: The automatic reference weight optimisation of the reference weight gradually improves the average piece weight value

- **only DS**: Freely programmable weighing unit, e.g. display directly in special units such as length of wire g/m, paper weight g/m², or similar

Technical data

- Large backlit LCD display, digit height 18 mm
- Weighing plate dimensions, stainless steel, WxDxH
A 228x228x90 mm
B 308x318x75 mm, see enlarged picture
C 450x350x115 mm
- Dimensions of display device WxDxH
 225x115x60 mm

STANDARD



OPTION



FACTORY



Model	Weighing range [Max] kg	Readout [d] g	Verific. value [e] g	Reproducibility g	Min. piece weight [Counting] g/piece	Net weight approx. kg	Weighing plate	Price excl. of VAT ex works €	Options			
									Verification		DAkkS Calibr. Certificate	
									M II KERN	€	DKD KERN	€
DS 3K0.01S	3	0,01	-	0,02	0,01	5,1	A	640,-	-	-	963-127	72,-
DS 5K0.05S	5	0,05	-	0,05	0,05	5,1	A	560,-	-	-	963-127	72,-
DS 8K0.05	8	0,05	-	0,05	0,05	7,5	B	550,-	-	-	963-128	88,-
DS 10K0.1S	10	0,1	-	0,1	0,1	4,5	A	530,-	-	-	963-128	88,-
DS 16K0.1	16	0,1	-	0,1	0,1	7,5	B	550,-	-	-	963-128	88,-
DS 20K0.1	20	0,1	-	0,1	0,1	7,5	B	580,-	-	-	963-128	88,-
DS 30K0.1	30	0,1	-	0,2	0,1	7,5	B	610,-	-	-	963-128	88,-
DS 30K0.1L	30	0,1	-	0,2	0,1	9,5	C	700,-	-	-	963-128	88,-
DS 36K0.2	36	0,2	-	0,2	0,2	7,5	B	550,-	-	-	963-128	88,-
DS 36K0.2L	36	0,2	-	0,2	0,2	9,5	C	660,-	-	-	963-128	88,-
DS 60K0.2	60	0,2	-	0,4	0,2	9,5	C	740,-	-	-	963-129	105,-
DS 65K0.5	65	0,5	-	0,5	0,5	9,5	C	700,-	-	-	963-129	105,-
DS 100K0.5	100	0,5	-	0,5	0,5	9,5	C	740,-	-	-	963-129	105,-
DS 150K1	150	1	-	1	1	9,5	C	740,-	-	-	963-129	105,-

Note: For applications that require verification, please order verification at the same time, initial verification at a later date is not possible. Verification at the factory, we need to know the full address of the location of use.

DS 65K1M	65	1	10	1	1	9,5	C	790,-	965-218	110,-	963-129	105,-
----------	----	---	----	---	---	-----	---	-------	---------	-------	---------	-------

IP protected platform scale KERN SFE



Platform scale with dust and spray protection IP65 and EC type approval [M]

Features

- Platform scale protected to IP65 with stainless steel display device, for industrial applications, hygienic and easy to clean
- Platform:** weighing plate stainless steel, painted steel base, protection against dust and water splashes IP65, silicone-coated aluminium load cell
- Display device:** stainless steel, protection against dust and water splashes IP65, for industrial applications, hygienic and easy to clean, flexible positioning, e.g. free-standing or mounted to the wall. For details see page 148, KERN KFE-TM
- Weighing with tolerance range (checkweighing):** Input of an upper/lower limit value. A visual and audible signal assists with portioning, dispensing or grading

- Hold function:** When the weighing conditions are unstable, a stable weight is calculated determining an average value
- PRE-TARE function** for manual subtraction of a known container weight, useful for checking fill-levels (only for non-verified models)

Technical data

- Large backlit LCD display, digit height 22 mm
- Weighing plate dimensions, stainless steel, WxDxH
 - A 300x240x110 mm
 - B 400x300x128 mm
 - C 500x400x137 mm
 - D 650x500x142 mm
- Dimensions of display device WxDxH 195x118x83 mm

- Cable length of display device approx. 3 m
- Rechargeable battery pack internal, standard, operating time up to 35 h without backlight, charging time approx. 12 h, can be re-ordered, KERN VFB-A02, € 40,-
- Permissible ambient temperature -10 °C / 40 °C

Accessories

- Tare pan made of stainless steel**, ideal for weighing loose screws, small parts etc., WxDxH 370x240x20 mm, KERN RFS-A02, € 55,-
- Stand to elevate display device**, must be ordered at purchase for models with weighing plate size
 - A, B, C, D: 2 height of stand approx. 200 mm, KERN SFE-A01, € 55,-
 - B, C, D: 3 height of stand approx. 400 mm, KERN SFE-A02, € 55,-
 - C, D: 3 height of stand approx. 600 mm, KERN SFE-A03, € 60,-

STANDARD



OPTION



FACTORY



Model	Weighing range [Max] kg	Readout [d] g	Verification value [e] g	Minimum load [Min] g	Net weight approx. kg	Weighing plate	Price excl. of VAT ex works €	Options					
								Verification		DAkkS Calibr. Certificate			
								M KERN	€	DKD KERN	€		
KERN													
SFE 6K-3M	6	2	2	40	6,5	A	380,-	965-228	55,-	963-128	88,-		
SFE 15K5IPM	15	5	5	100	6,5	A	360,-	965-228	55,-	963-128	88,-		
SFE 10K-3LM	15	5	5	100	8	B	420,-	965-228	55,-	963-128	88,-		
SFE 30K10IPM	30	10	10	200	6,5	A	360,-	965-228	55,-	963-128	88,-		
SFE 60K20IPM	60	20	20	400	8	B	410,-	965-229	93,-	963-129	105,-		
SFE 60K-2LM	60	20	20	400	14,5	C	520,-	965-229	93,-	963-129	105,-		
SFE 100K-2M	150	50	50	1000	8	B	420,-	965-229	93,-	963-129	105,-		
SFE 100K-2LM	150	50	50	1000	14,5	C	520,-	965-229	93,-	963-129	105,-		
SFE 100K-2XLM	150	50	50	1000	20	D	720,-	965-229	93,-	963-129	105,-		
SFE 300K-1LM	300	100	100	2000	20	D	720,-	965-229	93,-	963-129	105,-		

Note: For applications that require verification, please order verification at the same time, initial verification at a later date is not possible. Verification at the factory, we need to know the full address of the location of use.



09

Platform scale with stainless steel display device with IP68 rating, XL-display und EC type approval [M] – now also as high resolution version with high-resolution display



Piece-counting function



Durable stainless steel weighing plate



Stainless steel display device with IP67 protection, hygienic and easy to clean

IP protected platform scale KERN IXS



Features

- **Tough industry standard** suitable for use in harsh industrial applications
- **Display device:** Stainless steel, very high class of protection against dust and water IP68, for industrial applications, hygienic and easy to clean, with integrated power supply. Wall mount standard. For additional information see page 148, KERN KXS-TM
- **1 Flexible positioning of display device:** e.g. free-standing or mounted to the wall
- **Superior display size:** digit height 55 mm. Bright backlight for easy reading of weighing results, even in poor lighting conditions
- **2 Platform:** weighing plate stainless steel, substructure in wing design, extremely resistant to bending, steel, lacquered, protection against dust and water splashes IP65, silicone-coated aluminium load cell

Accessories

- **ESD drain to protect against electrostatic discharge** e.g. for electrostatically-charged weighing objects or people who work with the scale
- Thanks to the RS-232, RS-485 and Bluetooth (optional) interfaces, the scale can easily be connected to existing networks. Data exchange between the scale, PC or printer

Accessories

- **Stand**, can be retrofitted, for models with weighing plate size
 - A - D:** height of stand approx. 200 mm, KERN IXS-A02, € 70,-
 - B - D:** height of stand approx. 400 mm, KERN IXS-A03, € 75,-
 - C - D:** height of stand approx. 600 mm, KERN IXS-A04, € 85,-
- **Rechargeable battery pack internal**, operating time up to 80 h without backlight, charging time approx. 12 h, must be ordered at purchase, KERN GAB-A04, € 40,-
- **Data interface RS-232**, must be ordered at purchase, KERN KXS-A04, € 40,-
- **Data interface RS-485**, must be ordered at purchase, KERN KXS-A01, € 85,-
- **Bluetooth data interface** for wireless data transfer to PC or tablets, must be ordered at purchase, KERN KXS-A02, € 110,-
- **Foot switch**, must be ordered at purchase, for details see page 181, KERN KXS-A03, € 70,-
- **Suitable printers** see page 177 ff.

Technical data

- Large backlit LCD display, digit height 55 mm
- Weighing plate dimensions, stainless steel, WxDxH
 - A** 300x240x86 mm, **B** 400x300x89 mm
 - C** 500x400x123 mm
 - D** 650x500x133.5 mm
- Dimensions of display device WxDxH 232x170x80 mm
- Cable length of display device approx. 2,5 m
- Permissible ambient temperature -10 °C / 40 °C

STANDARD



OPTION



FACTORY



Model	Weighing range [Max] kg	Readout [d] g	Verification value [e] g	Minimum load [Min] g	Net weight approx. kg	Weighing plate	Price excl. of VAT ex works €	Options					
								Verification		DAkkS Calibr. Certificate			
								MID KERN	€	DKD KERN	€		
KERN													
IXS 6K-4	6	0,2	-	-	5,1	A	590,-	-	-	963-128	88,-		
IXS 10K-4	15	0,5	-	-	5,1	A	590,-	-	-	963-128	88,-		
IXS 10K-4L	15	0,5	-	-	10,5	B	590,-	-	-	963-128	88,-		
IXS 30K-3	30	1	-	-	10,5	B	590,-	-	-	963-128	88,-		
IXS 30K-3L	30	1	-	-	20,5	C	720,-	-	-	963-128	88,-		
IXS 60K-3	60	2	-	-	10,5	B	590,-	-	-	963-129	105,-		
IXS 60K-3L	60	2	-	-	20,5	C	720,-	-	-	963-129	105,-		
IXS 100K-3	150	5	-	-	20,5	C	720,-	-	-	963-129	105,-		
IXS 100K-3L	150	5	-	-	35	D	740,-	-	-	963-129	105,-		
IXS 300K-2	300	10	-	-	35	D	740,-	-	-	963-129	105,-		
Dual-range balance switches automatically to the next largest weighing range [Max] and readout [d].													
IXS 6K-3M	3 6	1 2	1 2	20 40	5,1	A	500,-	965-228	55,-	963-128	88,-		
IXS 10K-3M	6 15	2 5	2 5	40 100	5,1	A	500,-	965-228	55,-	963-128	88,-		
IXS 10K-3LM	6 15	2 5	2 5	40 100	10,5	B	590,-	965-228	55,-	963-128	88,-		
IXS 30K-2M	15 30	5 10	5 10	100 200	10,5	B	590,-	965-228	55,-	963-128	88,-		
IXS 30K-2LM	15 30	5 10	5 10	100 200	20,5	C	720,-	965-228	55,-	963-128	88,-		
IXS 60K-2M	30 60	10 20	10 20	200 400	10,5	B	590,-	965-229	93,-	963-129	105,-		
IXS 60K-2LM	30 60	10 20	10 20	200 400	20,5	C	720,-	965-229	93,-	963-129	105,-		
IXS 100K-2M	60 150	20 50	20 50	400 1000	20,5	C	720,-	965-229	93,-	963-129	105,-		
IXS 100K-2LM	60 150	20 50	20 50	400 1000	35	D	790,-	965-229	93,-	963-129	105,-		
IXS 300K-2M	150 300	50 100	50 100	1000 2000	35	D	790,-	965-229	93,-	963-129	105,-		

Note: For applications that require verification, please order verification at the same time, initial verification at a later date is not possible. Verification at the factory, we need to know the full address of the location of use.

New model

For more information, please visit kern-sohn.com/en/IXS · Order hotline +49 [0] 7433 9933-0

Industrial platform scale KERN IKT

PREMIUM
★★★



Alibi memory



- Ring memory for up to 49,152 measuring results (744 measuring results per day!)
- Saved measuring results cannot be changed or cleared. If the maximum memory capacity is reached, then the oldest value will be overwritten
- In addition to the measuring result, the date, time, tare value, a sequential number and the serial number of the balance are also saved.
- Saved measuring results can be searched and recalled easily
- The alibi memory can also be used for applications which do not require verification
- Complies with WELMEC 2.5

09 Touchscreen platform scale with enormous range of functions, available also with EC type approval [M]

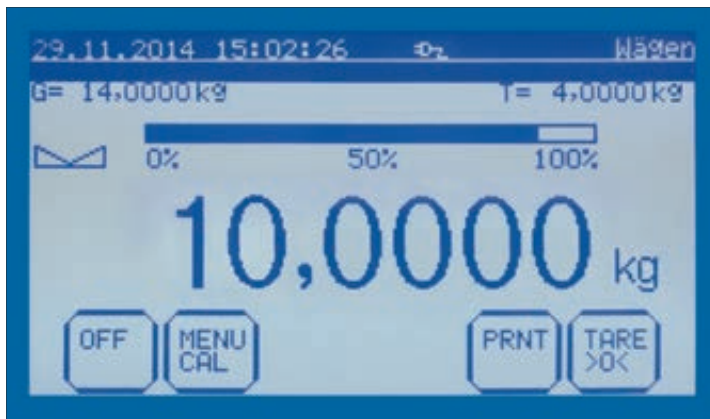

Display at full size, operating mode weighing

Innovative touchscreen: touch-sensitive, backlit screen with very good contrast for easy operation and convenient reading

Advantages:

- The menu and processes are self-explanatory
- No more errors or lost time through keys which have several functions assigned to them or unclear markings
- Large keys, which can also be operated, when wearing gloves
- More efficient, faster and safer working

Platform: Weighing plate stainless steel, painted steel base **A, B, D**, aluminium casting **D**, protection against dust and water splashes IP65, silicone-coated aluminium load cell



Easy entering of text and values

e.g. item descriptions, user name, weights of tare containers, etc. using the large keypad



80 memories for each mode

e.g. for checkweighing, PRE-TARE, reference weight, target weight for dispensing etc.

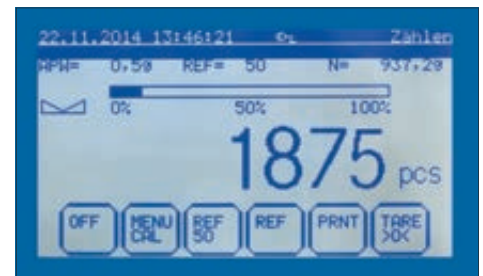

Professional counting function

All relevant counting information at a glance, such as, e.g., reference weight, reference quantity, total count, total weight, tare container weight, available weighing range and much more

Industrial platform scale KERN IKT

Features

- If one recipe ingredient is overweight, then the **practical recipe adjustment function** for when dosages are exceeded automatically calculates the new target weights of the other ingredients. The actual and target values and the proportionate percentage can then be printed
- Multiplier function:** recipes with the ingredient weights recorded as percentage values can easily be replicated by entering a new target weight. The ideal solution for the preparation of larger containers, bulk packs etc.
- Rapid function** for shortened stabilisation time with reduced readout
- Control outputs (optocoupler, digital I/O)** to connect relays, signal lamps, valves etc.

Technical data

- Backlit LCD graphic display with digit height 18 mm, screen diagonal 5.8" (approx. 147 mm, WxH 108x74 mm)
- Weighing plate dimensions, stainless steel, WxDxH
 - A** 228x228x90 mm
 - B** 318x308x75 mm
 - C** 450x350x115 mm, see enlarged picture
 - D** 650x500x142 mm
- Dimensions of display device WxDxH 200x155x68 mm

- Cable length of display device for weighing plate size, **A** approx. 1 m, **B**, **D** approx. 2 m, **C** approx. 0,6 m
- Permissible ambient temperature 10 °C / 40 °C

Accessories

- Protective working cover** over the display device standard. Can be re-ordered, scope of delivery: 5 items, KERN IKT-A01, **€ 25,-**
- Rechargeable battery pack external**, operating time up to 20 h without backlight, charging time approx. 10 h, can be retrofitted, not for IKT-M, KERN KS-A01, **€ 180,-**
- Signal lamp** for visual support of weighing with tolerance range, KERN IKT-A04, **€ 250,-**
- RS-232/Ethernet adapter**, to connect balances with an RS-232 interface to a network via Ethernet, for details see page 180, KERN YKI-01, **€ 390,-**
- RS-232/USB adapte**, to connect peripheral devices with USB connection, for details see page 181, KERN AFH 12, **€ 85,-**
- Set for underfloor weighing**, only for models with weighing plate size **B**, KERN DS-A01, **€ 200,-**
- Stand** to elevate display device, height of stand approx. 480 mm, only for models with weighing plate size **B**, **C**, KERN IKT-A06, **€ 100,-**
- Wall mount** for display device, KERN IKT-A03, **€ 35,-**
- Suitable printers** see page 177 ff.

Modes

- Weighing
- Counting
- Dispensing
- Recipe weighing
- Checkweighing
- Totalising with daily total
- Percentage determination
- Animal weighing
- Surface weight
- Density determination, only with **B**
- Rapid function, not for

Functions

- Capacity display, with ① - ②, ⑤ - ⑦, ⑨ - ⑪
- Dispensing aid (subtractive/additive), with ③, ④
- Net/gross display, permanent, with ①, ③ - ⑤, ⑧ - ⑪
- Variable reference quantity, with ②
- Automatic reference optimisation, with ②
- PRE-TARE numerical or from the memory unit, with ① - ⑦, ⑪
- Input of item or batch description, operator etc., with ① - ⑦
- Freely programmable weighing unit, e.g. display direct in special units such as length of thread g/m, grammage g/m², or similar, with ②
- Date/time, with ① - ⑪
- Statistical function, with ①
- GLP printout, with ① - ⑪
- Individual formatting of up to 16 printer forms, recipes, operating mode master data in MS Excel, import via RS-232, for examples, see the internet, with ① - ⑪

STANDARD



OPTION



FACTORY



Model	Weighing range [Max] kg	Readout [d] g	Verification value [e] g	Minimum load [Min] g	Min. piece weight [Counting] g/piece	Net weight approx. kg	Weighing plate	Price excl. of VAT ex works €	Options				
									Verification		DAkkS Calibr. Certificate		
									M III KERN	€	DKD KERN	€	
KERN													
IKT 6K0.1	6	0,1	-	-	0,1	7,5	B	830,-	-	-	963-128	88,-	
IKT 12K0.2	12	0,2	-	-	0,2	7,5	B	830,-	-	-	963-128	88,-	
IKT 30K0.5	30	0,5	-	-	0,5	7,5	B	830,-	-	-	963-128	88,-	
IKT 60K1L	60	1	-	-	1	9,5	C	1050,-	-	-	963-129	105,-	
IKT 120K2L	120	2	-	-	2	9,5	C	1050,-	-	-	963-129	105,-	
IKT 150K2XL	150	2	-	-	2	20	D	1200,-	-	-	963-129	105,-	
IKT 300K5XL	300	5	-	-	5	20	D	1200,-	-	-	963-129	105,-	
High-resolution display													
IKT 3K0.01S	3	0,01	-	-	0,01	5,1	A	920,-	-	-	963-127	72,-	
IKT 8K0.05	8	0,05	-	-	0,05	7,5	B	850,-	-	-	963-128	88,-	
IKT 10K0.1S	10	0,1	-	-	0,1	5,1	A	850,-	-	-	963-128	88,-	
IKT 16K0.1	16	0,1	-	-	0,1	7,5	B	850,-	-	-	963-128	88,-	
IKT 30K0.1	30	0,1	-	-	0,1	7,5	B	850,-	-	-	963-128	88,-	
IKT 30K0.1L	30	0,1	-	-	0,1	9,5	C	1150,-	-	-	963-128	88,-	
IKT 36K0.2	36	0,2	-	-	0,2	7,5	B	850,-	-	-	963-128	88,-	
IKT 36K0.2L	36	0,2	-	-	0,2	9,5	C	1050,-	-	-	963-128	88,-	
IKT 60K0.2L	60	0,2	-	-	0,2	9,5	C	1120,-	-	-	963-129	105,-	
IKT 65K0.5L	65	0,5	-	-	0,5	9,5	C	1050,-	-	-	963-129	105,-	
IKT 100K0.5L	100	0,5	-	-	0,5	9,5	C	1150,-	-	-	963-129	105,-	
IKT 150K1L	150	1	-	-	1	9,5	C	1150,-	-	-	963-129	105,-	

Note: For applications that require verification, please order verification at the same time, initial verification at a later date is not possible. Verification at the factory, we need to know the full address of the location of use.

IKT 6K1M	6	1	1	20	1	7,5	B	990,-	950-128	55,-	963-128	88,-
IKT 12K2M	12	2	2	40	2	7,5	B	990,-	950-128	55,-	963-128	88,-
IKT 30K5M	30	5	5	100	5	7,5	B	1010,-	950-128	55,-	963-128	88,-
IKT 60K10LM	60	10	10	200	10	9,5	C	1250,-	950-129	93,-	963-129	105,-
IKT 120K20LM	120	20	20	400	20	9,5	C	1250,-	950-129	93,-	963-129	105,-

Platform scale KERN ILT

PREMIUM



Note

for information on further useful functions for this range, please see pages 6 and 7



KERN ILT-BAM



KERN ILT-BAM

KERN ILT-NM

KERN ILT-GAM

Modes

- ① Weighing
- ② Counting
- ③ Percentage determination
- ④ Dispensing
- ⑤ Recipe weighing
- ⑥ Density determination
- ⑦ Animal weighing

Functions

- Capacity display, with ① - ⑦
- Dispensing assistance, with ④, ⑤
- Net/gross display, permanent, with ① - ⑦
- Variable reference quantity, with ②
- Automatic reference optimisation, with ②
- PRE-TARE numerical or from the memory unit, with ① - ⑦
- Input of item or batch description, operator etc., with ① - ⑦
- Freely programmable weighing unit, with ① - ⑦
- Date/time, with ① - ⑦
- Statistical function, with ① - ⑦
- GLP printout, with ① - ⑦
- Individual formatting with ① - ⑦

User-friendly piece-counting function:

creation and recall items to be counted from the database with all relevant additional data such as piece weight, name, price (for internal valuation), reference quantity, tare container weight, barcode, item image etc. Also integrated: automatic reference optimisation, correction of reference weights, freely selectable reference quantity and much more

Note: on the basis of the KERN ILT range, you can put together a wide range of high-performance counting systems - your KERN product specialist will be pleased to advise you

Modern premium touchscreen platform scale with the complete range of functions for demanding processes

Backlit and touch-sensitive LCD display

with digit height 21 mm, screen diagonal 5,7" (145 mm), WxH 115x86 mm. Dimensions of display device WxDxH 215x156x71 mm. Thanks to the interactive touch display, the menu and processes are self-explanatory. This reduces the training times, avoids operating errors and in this way, ensures more efficient functionality

Intuitive operation, increases efficiency and saves costs: Easy capture of item data at the PC, call up of items on the balance using the connected barcode or RFID scanner, output of weighing data using the large or second display or control outputs, data transfer to the PC, printer or alibi memory.



Identification by RFID: rapid and secure identification of users, items, vehicles, etc. using the optional RFID transponder card reader. The data can be read and edited (suitable for ILT-BAM, -GAM, KXE-TAM)



Item recognition using the optional barcode scanner is possible, see accessories. Ideal for rapid recording of items, e.g. as part of a stocktake or to record recipe ingredients as part of a recipe etc.

Platform scale KERN ILT

Features

- **Convenient recipe-weighing:** complete recipes with all recipe ingredients and associated target values, names, tolerances, tare weights etc. can be stored. If there is an excess amount of one recipe ingredient the practical back calculation function automatically calculates the new target weights of the other ingredients
- **Multiplier function:** recipes with the ingredient weights recorded as percentage values can easily be replicated by entering a new target weight. The ideal solution for the preparation of larger containers, bulk packs etc.
- **Best-before dates** can be stored and printed for each item
- **Statistical function** for statistical analysis of series of measurements
- **User-friendly batch management** with batch master and batch number assignment, classification, batch derivation, batch determination, batch status management, shelf-life processing, documentary, original and WIP batches, batch-specific units of measure, batch where-used list
- **Individual user settings can be stored:**
 - User name and number
 - Password
 - Menu language
 - User profile
 - Additional guest mode for users without log-in
 - Authorisations
- **Enormous database** for thousands of weighing results, items, recipes, recipe ingredients, container weights, user data etc. ILT-BAM, -GAM: 8 GB, ILT-NM,-C: 1 GB
- **Alibi memory:** paperless archive of weighing results, see page 214

- **Electronic level indicator** continuously checks the position of the balance, sounds an alarm when the device is out of balance and gives visual instructions on how to correct the situation (only ILT-NM, -C)
- **High level of process reliability:** you can define limit values for selected parameters, such as temperature, levelling, minimum load, adjustment, etc. When the value limit exceeds or falls below, a warning message will be issued and this can be stored with the measuring result
- **Individual print formats:** Printouts can be individually adjusted depending on operating mode, application or your own requirements, directly at the balance or the PC.

Technical data

- Cable length of display device ILT-BAM approx. 2,5 m; ILT-GAM, -NM, -C approx. 1 m
- Permissible ambient temperature
ILT-NM, -BAM: 15 °C / 35 °C
ILT-GAM -10 °C / 40 °C

Accessories

- only -GAM: **Protective working cover** over the display device standard. Can be re-ordered, scope of delivery: 5 items, KERN ILT-A02S05, € 19,-
 - **Transponder card reader**, RFID technology, dimensions WxDxH100x135x30 mm, for details see page 186, KERN KET-A05, € 450,-
 - **Transponder cards**, 10 pieces, for details see page 186, KERN KET-A08, € 65,-
 - **Barcode scanner**, hand-held version, dimensions WxDxH 152x84x63 mm, details see page 184,
- Variant RS-232, KERN PET-A05, € 350,-
Variant USB, KERN PET-A09, € 350,-
- only-BAM,-GAM: **Signal lamp** for visual support of weighing with tolerance range. For details see page 187, KERN KET-A10, € 270,-
 - **Wall mount** for display device, dimensions WxDxH 135x148x110 mm, for details see page 184, KERN KET-A02, € 190,-
 - **Second display**, dimensions WxDxH 150x34x80 mm, for details see page 184, KERN KET-A03, € 210,-
 - **Large display**, stainless steel, digit height 111,7 mm, dimensions WxDxH 635x195x48 mm, for details see page 184, KERN KET-A06, € 1450,-
 - **Analogue/Digital converter** to connect up to two platforms to the display device, for details see page 187, KERN KET-A01, € 350,-
 - **Label printer**, software for easy editing of (adhesive) labels included, for details see page 184
thermodirect: KERN PET-A13, € 980,-
thermotransfer and thermodirect: KERN PET-A14, € 1000,-
 - **Software for database management**, for convenient maintenance of item data at the PC. For details see page 184, KERN KET-A04, € 300,-
 - **Cable with special length**, between display device and platform, for verified models which must be ordered at the time of purchase, KERN ILT-A03, € 250,-
 - **RS-232/USB adapter**, to connect peripheral devices with USB connection, for details see page 181, KERN AFH 12, € 85,-
 - **Suitable printers** and further, extensive accessories from page 177 ff.

STANDARD

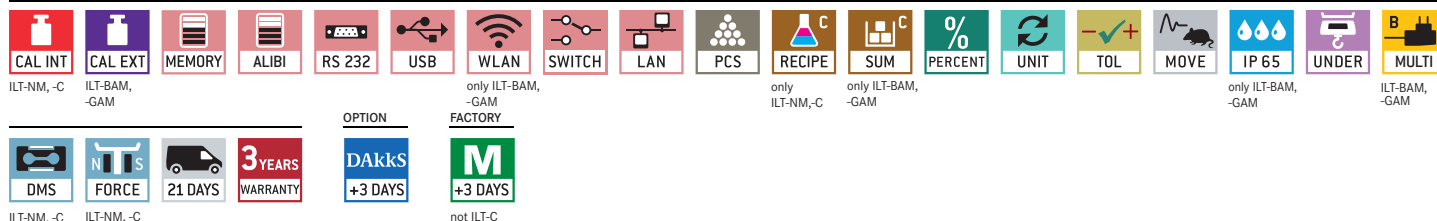

Model	Weighing range [Max] kg	Readout [d] g	Verification value [e] g	Minimum load [Min] g	Weighing plate mm	Price excl. of VAT ex works €	Options			
							Verification		DAkkS Calibr. Certificate	
							M KERN	€	DKD KERN	€
ILT 6K-3GAM	3 6	1 2	1 2	40	230x230	2200,-	965-228 (M)	55,-	963-128	88,-
ILT 6K-4BAM	6	0,1	1	5	195x195	2200,-	965-217 (M)	77,-	963-128	88,-
ILT 10K-3GAM	6 15	2 5	2 5	40	300x240	1900,-	965-228 (M)	55,-	963-128	88,-
ILT 10K-3LGAM	6 15	2 5	2 5	40	400x300	1870,-	965-228 (M)	55,-	963-128	88,-
ILT 10K-5NM	10	0,01	0,1	0,5	347x259	3600,-	965-217 (M)	77,-	963-128	88,-
ILT 30K-2GAM	15 30	5 10	5 10	200	400x300	2200,-	965-228 (M)	55,-	963-128	88,-
ILT 60K-2GAM	30 60	10 20	10 20	400	400x300	2200,-	965-229 (M)	93,-	963-129	105,-
ILT 60K-2LGAM	30 60	10 20	10 20	400	500x400	2150,-	965-229 (M)	93,-	963-129	105,-
ILT 35K-4NM	35	0,1	1	5	347x259	4200,-	965-217 (M)	77,-	963-128	88,-
ILT 50K-4C	50	0,1	-	-	347x259	5500,-	-	-	963-128	88,-
ILT 60K-3BAM	60	1	10	50	500x400	2400,-	965-218 (M)	110,-	963-129	105,-
ILT 100K-2GAM	60 150	20 50	20 50	1000	500x400	2100,-	965-229 (M)	93,-	963-129	105,-
ILT 100K-2LGAM	60 150	20 50	20 50	1000	650x500	2200,-	965-229 (M)	93,-	963-129	105,-
ILT 300K-2GAM	150 300	50 100	50 100	2000	650x500	2200,-	965-229 (M)	93,-	963-129	105,-

Dual-range balance switches automatically to the next largest weighing range [Max] and readout [d].

Note: For applications that require verification, please order verification at the same time, initial verification at a later date is not possible. Verification at the factory, we need to know the full address of the location of use.

Precision platform scales KERN ILS-C · ILJ-C



High-resolution industrial scale, available also with internal adjustment and EC type approval [M]

Technical data

- Large backlit LCD display, digit height 18 mm
- Dimensions of weighing plate WxD 347x259 mm
- Dimensions of display device WxDxH 270x165x115 mm
- Permissible ambient temperature 10 °C / 40 °C

Accessories

- **Protective working cover** over the display device, standard. Can be re-ordered, scope of delivery: 5 items, KERN ILS-A02, € 25,-
- **WLAN interface** for wireless connection of the balance to networks and WLAN capable devices, such as tablets, laptops or smartphones, KERN PLJ-A06, € 135,-
- **Alibi memory software** for viewing and saving data from the alibi memory onto a PC connected to the system, KERN PET-A16, € 300,-
- **Suitable printers** and further, extensive accessories from page 177 ff.

09 Features

- **Laboratory scale with separate display device:** Ideal when working in a glove bag or under laboratory fume hoods. Particularly practical for weighing toxic, volatile or contaminated substances
- **1** Particularly suitable for compact, very dense samples, e.g. those in road construction or the construction industry
- **Robust construction of platform** ensures stability, protects the weighing system and is durable enough for with everyday use
- **2** only KERN ILJ-C: **Automatic internal adjustment** in the case of temperature change ≥ 3 °C and time-controlled every 3 hours
- **Alibi memory:** paperless archive of weighing results, see page 214

- **Internal memory** for up to 999 weighing results, 1000 items or recipe ingredients, 100 container weights, 100 users
- **PRE-TARE function** for manual subtraction of a known container weight, useful for checking fill-levels
- **Weighing with tolerance range (checkweighing):** a visual signal helps with portioning, dispensing or grading
- **Totalising** of weights (manual/automatic)
- **GLP/ISO record keeping of weight values** with date, time, user ID, project and serial number in combination with an appropriate KERN printer
- **Density determination** of liquids and solids. Step by step user guidance on display. The density is indicated directly on the display. Note: For interesting facts about density determination see page 214
- **Hook** for underfloor weighing standard

STANDARD

OPTION FACTORY



Model	Weighing range [Max]	Readout [d]	Verification value [e]	Minimum load [Min]	Net weight approx.	Price excl. of VAT ex works €	Options			
							Verification		DAkkS Calibr. Certificate	
KERN	kg	g	g	g	kg	€	MD KERN	€	DKD KERN	€
ILS 30K-4C	30	0,1	-	-	14,5	1790,-	-	-	963-128	88,-
ILS 50K-4C	50	0,1	-	-	14,5	2320,-	-	-	963-128	88,-
Note: For applications that require verification, please order verification at the same time, initial verification at a later date is not possible. Verification at the factory, we need to know the full address of the location of use.										
ILJ 25K-4CM	25	0,1	1	5	19,9	2050,-	965-217	77,-	963-128	88,-

Floor scales/Pallet scales/Drive-through scales

Robust aid for weighing large loads

KERN offers a carefully coordinated range from affordable entry level models, to practical built-in solutions, up to the top level verified models made of stainless steel. Their common feature is the long-lasting industrial quality as well as the high level of protection against dust and spray.

The installation, startup, and possible verification of floor, pallet, and drive-through scales require specialised knowledge, which is the basis for a successful sale. Please ask for our "Floor scale info sheet".

High-capacity scales – ideal for piece counting with large item quantities



The weighing ranges of bench counting scales are often not sufficient to count large quantities, units, palletised items etc. This is where high-performance counting systems are employed as these combine a high-precision reference balance with a high-capacity bulk scale, such as e.g. floor scales, pallet scales or drive-through scales. Your personal KERN customer consultant will be happy to help you setting up the right high-capacity counting system.

Individuality is the trump card

Do you have any special requests, which are not covered by our extensive floor scale range? Then why not configure your ideal model yourself, it's quick, individual and affordable.

Of course we can also offer you the complete service and put the required scale combination together for you, including verification. All further details can be found from page 177 ff. or ask your personal customer service agent, he will be pleased to advise you

Your product specialist's recommendation:

-  **Massive steel weighing bridge with IP65 protection**
-  **Stainless steel display device with IP68 protection**
-  **Screwed on weighing plate, easy to remove, hygienic and easy to clean**



Stephan Ade

Product specialist Floor scales/Pallet scales/
Drive-through scales

Tel. +49 [0] 7433 9933-121
Fax +49 [0] 7433 9933-29121
ade@kern-sohn.com











from €
1350,-

► page 126

KERN BXS

Quick-Finder Floor scales/Pallet scales/Drive-through scales

Read-out [d]	Weighing range [Max]	Weighing plate mm	Model KERN	Price excl. of VAT ex works €	Page									For an explanation on the pictos, see the front flap													
200 g	600 kg	840x1190x90	UFB 600K200M	890,-	134	2	○	●	●	●	●	●	○	○													
200 g	600 kg	1000x1000x85	BFS 600K-1SNM	1050,-	127	5	○	●	●	●	●	○	○														
200 g	600 kg	1000x1000x85	BFA 600K-1SNM	1110,-	128	5	○	●	○	●	●	●	○														
200 g	600 kg	1000x1000x85	BFB 600K-1SNM	1110,-	125	2	○	●	●	●	●	○	○														
200 g	600 kg	840x1190x90	UFC 600K-1M	1280,-	135	5	○	●	○	●	●	○	○														
200 g	600 kg	1600x1200x78	NFB 600K200M	1290,-	137	2	○	●	●	●	●	○	○														
200 g	600 kg	1000x1000x80	BXS 600K-1SM	1350,-	126	2	○	●	○	●	●	●	○														
200 g	600 kg	1500x1250x85	BFB 600K-1NM	1420,-	125	2	○	●	●	●	●	○	○														
200 g	600 kg	1500x1250x85	BFS 600K-1NM	1450,-	127	5	○	●	●	●	●	○	○														
200 g	600 kg	1800x1400x78	NFB 600K200LM	1450,-	137	2	○	●	●	●	●	○	○														
200 g	600 kg	1500x1250x85	BFA 600K-1NM	1490,-	128	5	○	●	○	●	●	●	○														
200 g	600 kg	1500x1250x80	BXS 600K-1M	1650,-	126	2	○	●	○	●	●	●	○														
200 g	600 kg	1000x1000	NBB 600K-1M	1670,-	138	5	○	●	○	●	●	○	○														
200 g	600 kg	1200x1200	NBB 600K-1LM	1770,-	138	5	○	●	○	●	●	○	○														
200 g	600 kg	840x1190x90	UFN 600K200IPM	1700,-	136	2	○	●	○	●	●	●	○														
200 g	600 kg	1000x1000x80	BFN 600K-1SM	2650,-	131	2	○	●	○	●	●	●	○														
200 g	600 kg	1000x1000	NFN 600K-1M	2880,-	139	2	○	●	○	●	●	●	○														
200 g	600 kg	1000x1000x80	BAN 600K-1SM	3050,-	130	2	○	●	○	●	●	●	○														
200 g	600 kg	1000x1000x85	BBB 600K-1SNM	3500,-	129	23	○	●	○	●	●	●	○														
200 g	600 kg	1500x1250x85	BBB 600K-1NM	3900,-	129	23	○	●	○	●	●	●	○														
200 g	600 kg	1000x1000x80	BBN 600K-1SM	5100,-	132	23	○	●	○	●	●	●	○														
500 g	1,5 t	1200x120x100	UFA 1.5T0.5	850,-	133	2	○	●	○	●	●	○	○														
500 g	1,5 t	840x1190x90	UFB 1.5T0.5M	890,-	134	2	○	●	○	●	●	○	○														
500 g	1,5 t	1000x1000x85	BFB 1T-4SNM	1050,-	125	2	○	●	○	●	●	○	○														
500 g	1,5 t	1000x1000x85	BFS 1T-4SNM	1050,-	127	5	○	●	○	●	●	○	○														
500 g	1,5 t	1000x1000x85	BFA 1T-4SNM	1140,-	128	5	○	●	○	●	●	●	○														
500 g	1,5 t	840x1190x90	UFC 1T-1M	1280,-	135	5	○	●	○	●	●	○	○														
500 g	1,5 t	1600x1200x78	NFB 1.5T0.5M	1290,-	137	2	○	●	○	●	●	○	○														
500 g	1,5 t	1000x1000x80	BXS 1.5T-4SM	1350,-	126	2	○	●	○	●	●	●	○														
500 g	1,5 t	1500x1250x80	BFB 1T-4NM	1450,-	125	2	○	●	○	●	●	○	○														
500 g	1,5 t	1500x1250x85	BFS 1T-4NM	1450,-	127	5	○	●	○	●	●	○	○														
500 g	1,5 t	1800x1400x78	NFB 1.5T0.5LM	1460,-	137	2	○	●	○	●	●	○	○														
500 g	1,5 t	1500x1250x85	BFA 1T-4NM	1540,-	128	5	○	●	○	●	●	●	○														
500 g	1,5 t	1500x1250x80	BXS 1.5T-4M	1650,-	126	2	○	●	○	●	●	●	○														
500 g	1,5 t	1000x1000	NBB 1T-1M	1660,-	138	5	○	●	○	●	●	○	○														
500 g	1,5 t	840x1190x90	UFN 1.5T0.5IPM	1700,-	136	2	○	●	○	●	●	●	○														
500 g	1,5 t	1200x1200	NBB 1T-1LM	1860,-	138	5	○	●	○	●	●	○	○														
500 g	1,5 t	1000x1000x80	BFN 1T-4SM	2650,-	131	2	○	●	○	●	●	●	○														
500 g	1,5 t	1000x1000	NFN 1.5T-4M	2880,-	139	2	○	●	○	●	●	●	○														
500 g	1,5 t	1000x1000x80	BAN 1T-4SM	3050,-	130	2	○	●	○	●	●	●	○														
500 g	1,5 t	1500x1250x80	BFN 1.5T0.5M	3350,-	131	2	○	●	○	●	●	●	○														
500 g	1,5 t	1000x1000x85	BBB 1T-4SNM	3500,-	129	23	○	●	○	●	●	●	○														
500 g	1,5 t	1500x1250x80	BAN 1T-4M	3750,-	130	2	○	●	○	●	●	●	○														
500 g	1,5 t	1500x1250x85	BBB 1T-4NM	3900,-	129	23	○	●	○	●	●	●	○														
500 g	1,5 t	1000x1000x80	BBN 1T-4SM	5100,-	132	23	○	●	○	●	●	●	○														
500 g	1,5 t	1500x1250x80	BBN 1T-4M	5800,-	132	23	○	●	○	●	●	●	○														
1000 g	3 t	1200x120x100	UFA 3T1	850,-	133	2	○	●	○	●	●	○	○														
1000 g	3 t	2000x120x100	UFA 3T-3L	995,-	133	2	○	●	○	●	●	○	○														
1000 g	3 t	1500x1250x85	BFB 3T-3NM	1420,-	125	2	○	●	○	●	●	○	○														
1000 g	3 t	1500x1250x85	BFS 3T-3NM	1450,-	127	5	○	●	○	●	●	○	○														
1000 g	3 t	1500x1500x80	BFB 3T1LM	1610,-	125	2	○	●	○	●	●	○	○														
1000 g	3 t	1500x1250x85	BFA 3T-3NM	1490,-	128	5	○	●	○	●	●	●	○														
1000 g	3 t	1500x1250x80	BXS 3T-3M	1600,-	126	2	○	●	○	●	●	●	○														
1000 g	3 t	1500x1500x80	BFS 3T-3LM	1650,-	127	5	○	●	○	●	●	○	○														
1000 g	3 t	1500x1500x80	BFA 3T-3LM	1700,-	128	5	○	●	○	●	●	●	○														
1000 g	3 t	1500x1250x80	BFN 3T-3M	3350,-	131	2	○	●	○	●	●	●	○														
1000 g	3 t	1500x1250x80	BAN 3T-3M	3750,-	130	2	○	●	○	●	●	●	○														
1000 g	3 t	1500x1250x85	BBB 3T-3NM	3900,-	129	23	○	●	○	●	●	●	○														
1000 g	3 t	1500x1500x80	BBB 3T-3LM	4100,-	129	23	○	●	○	●	●	●	○														
1000 g	3 t	1500x1250x80	BBN 3T-3M	5800,-	132	23	○	●	○	●	●	●	○														
2000 g	6 t	1200x163x80	UFA 6T-3	1190,-	133	2	○	●	○	●	●	○	○														
2000 g	6 t	2100x160x85	UFA 6T-3L	1490,-	133	2	○	●	○	●	●	○	○														
2000 g	6 t	1500x1500x130	BFB 6T-3M	1950,-	125	2	○	●	○	●	●	○	○														
2000 g	6 t	1500x1500x130	BFS 6T-3M	1950,-	127	5	○	●	○	●	●	○	○														
2000 g	6 t	1500x1500x130	BFA 6T-3M	2040,-	128	5	○	●	○	●	●	●	○														
2000 g	6 t	1500x1500x130	BBB 6T-3M	4500,-	129	23	○	●	○	●	●	●	○														

■ = News 2016

*For an explanation on the pictos, see the front flap

● = Standard

○ = Option

Floor scale KERN BFB

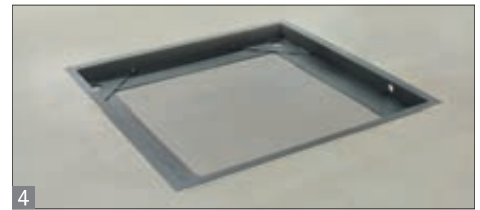
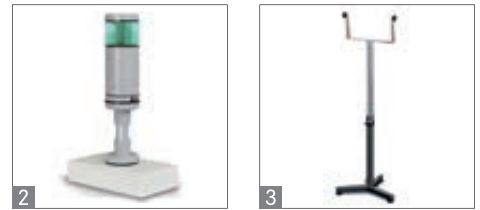

Weighing bridge with screwed on weighing plate (IP67) and XXL display device, with EC type approval [M]

Features

- **1 Weighing bridge:** steel, lacquered, weighing plate size **C**, **D** corrugated steel plate, protection against dust and water splashes (IP67), 4 silicone-coated steel load cells. Weighing bridge can also be delivered as components without the display device KERN KFP V20 IP67 protection, details see page 151
- **1 Weighing plate** **A** **B** screwed on from the top, so it's easy to remove, hygienic and easy to clean
- **Easy levelling of the weighing bridge** as well as **access to the junction box** from above
- **Comfortable adjustment of the weighing bridge** from above
- **Display device KERN KFB-TM**, details see page 147
- **Benchtop stand incl. wall mount** for display device as standard
- **Totalising** of weights and piece counts

Technical data

- Large backlit LCD display, digit height 52 mm
- Weighing plate dimensions WxDxH

- A** 1000x1000x80 mm, **B** 1500x1250x80 mm
- C** 1500x1500x80 mm
- D** 1500x1500x130 mm, welded
- Dimensions of display device WxDxH 250x160x58 mm
- Cable length of display device approx. 5 m
- Permissible ambient temperature -10 °C / 40 °C

Accessories

- **Protective working cover** over the display device standard. Can be re-ordered, scope of delivery: 5 items, KERN KFB-A02S05, **€ 35,-**
- **2 Signal lamp** for visual support of weighing with tolerance range, for details see page 181, KERN CFS-A03, **€ 250,-**
- **3 Stand** to elevate display device, height of stand 750-1000 mm, KERN BFS-A07, **€ 120,-**
- **Pair of base plates** to fix the weighing bridge to the floor, for models with weighing plate size **A**, **B**, **C** KERN BFS-A06N, **€ 60,-**
D KERN BFS-A10, **€ 60,-**
- **4 Stable pit frame** for weighing bridge installation, allowing for easy access, for models with weighing plate size **A** 1085x1085 mm, KERN BFS-A03N, **€ 210,-**

Note: For verified scales the weighing bridge must be fixed to the floor. Optionally, with an access ramp, a footplate pair or a pit frame

Limited tare range with verifiable models **C**, **D** (1/6 from [Max])

1 Shipment via freight forwarder. Please ask for dimensions, gross weight, shipping costs

- B** 1335x1585 mm, KERN BFS-A04N, **€ 250,-**
- C** 1585x1585 mm, KERN BFS-A08, **€ 250,-**
- **Rechargeable battery pack internal**, operating time up to 35 h, charging time approx. 10 h, must be ordered at purchase, KERN KFB-A01, **€ 35,-**
- **Ascending ramp**, not included, for models with weighing plate size WxDxH **A** 1000x760x85 mm, KERN BFS-A01N, **€ 300,-**
B 1250x870x85 mm, KERN BFS-A02N, **€ 350,-**
C 1500x760x85 mm, KERN BFS-A09, **€ 410,-**
D 1500x750x121 mm, KERN BFS-A11, **€ 500,-**
- **Large display with superior display size**, digit height 76 mm. WxDxH 541x55x180 mm, details see page 181, KERN YKD-A02, **€ 215,-**
- **Cable with special length 15 m**, between display device and platform, for verified models, this must be ordered at the time of purchase, KERN BFB-A03, **€ 160,-**
- **Suitable printers** and further, extensive accessories from page 177 ff.

STANDARD



OPTION



FACTORY



Model	Weighing range [Max] kg	Readout = Verification value [d] = [e] kg	Minimum load [Min] kg	Net weight approx. kg	Dimensions of weighing plate WxDxH mm	Price excl. of VAT ex works €	Options			
							Verification		DAkkS Calibr. Certificate	
							M KERN	€	DKD KERN	€
BFB 600K-1SNM	600	0,2	4	105	A 1000x1000x85	1 110,-	965-230	132,-	963-130	165,-
BFB 600K-1NM	600	0,2	4	136	B 1500x1250x85	1 420,-	965-230	132,-	963-130	165,-
BFB 1T-4SNM	1500	0,5	10	105	A 1000x1000x85	1 050,-	965-230	132,-	963-130	165,-
BFB 1T-4NM	1500	0,5	10	133	B 1500x1250x85	1 450,-	965-230	132,-	963-130	165,-
BFB 3T-3NM	3000	1	20	135	B 1500x1250x85	1 420,-	965-232	320,-	963-132	440,-
BFB 3T1LM	3000	1	20	152	C 1500x1500x80	1 610,-	965-232	320,-	963-132	440,-
BFB 6T-3M	6000	2	40	210	D 1500x1500x130	1 950,-	965-232	320,-	963-132	440,-

Note: For applications that require verification, please order verification at the same time, initial verification at a later date is not possible. Verification at the factory, we need to know the full address of the location of use.

Floor scale KERN BXS

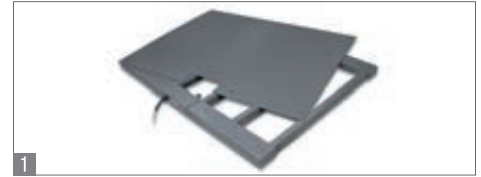

Note: For verified models the weighing bridge must be fixed to the floor. Optionally, through an access ramp, a pair of base plates or a pit frame

Shipment via freight forwarder. Please ask for dimensions, gross weight, shipping costs

Weighing bridge with screwed on weighing plate (IP67) and stainless steel display device (IP68), with EC type approval [M]

Features

- Industrial quality:** heavy version for tough usage in industrial applications
- 1 Weighing plate screwed on from the top**, so it's easy to remove, hygienic and easy to clean
- 2 Weighing bridge:** Lacquered steel, extremely resistant to bending due to material thickness, protection against dust and water splashes IP67, 4 silicone-coated steel load cells. Weighing bridge can also be delivered as components without the display device, KERN KXP V20 IP67, information on page 150
- Easy levelling of the weighing bridge** as well as **access to the junction box** from above
- 3 Display device:** stainless steel, protection against dust and water splashes IP68, for industrial applications, hygienic and easy to clean, **with integrated power supply** and superior display size. The display device can

also be delivered as a component without the weighing bridge, KERN KXS-TM, information on page 148

- Benchtop stand incl. wall mount** for display device as standard
- Totalising** of weights and piece counts
- Thanks to the RS-232, RS 485 and Bluetooth (optional) interfaces, the balance can easily be connected to existing networks. Data exchange between the balance and PC or printer is also made easier

Technical data

- Large backlit LCD display, digit height 55 mm
- Dimensions of display device WxDxH 232x170x80 mm
- Cable length of display device approx. 5 m
- Permissible ambient temperature -10 °C / 40 °C

Accessories

- Stand** to elevate display device, height of stand 750–1000 mm, KERN YKP-02, **€ 210,-**
- Ascending ramp**, corrugated steel plate, lacquered, only for models with weighing plate sizes
 - A** WxDxH 1000x840x85 mm, KERN BXS-A01, **€ 300,-**
 - B** WxDxH 1250x840x85 mm, KERN BXS-A02, **€ 360,-**
- Pair of base plates** to fix the weighing bridge to the floor, KERN BXS-A03, **€ 70,-**
- Rechargeable battery pack internal**, operating time up to 80 h, without backlight, charging time approx. 12 h, must be ordered at purchase, KERN GAB-A04, **€ 40,-**
- Bluetooth data interface** for wireless data transfer to PC or Tablets, must be ordered at purchase, KERN KXS-A02, **€ 110,-**
- Data interface RS-232**, interface cable included, approx. 1.5 m, must be ordered at purchase, KERN KXS-A04, **€ 40,-**
- Data interface RS-485**, must be ordered at purchase, KERN KXS-A01, **€ 85,-**
- Foot switches**, must be ordered at purchase, KERN KXS-A03, **€ 70,-**
- Cable with special length** 15 m, between display device and platform, must be ordered at purchase, KERN BFB-A03, **€ 160,-**
- Suitable printers** and an extensive accessories range see page 177

STANDARD



OPTION



FACTORY

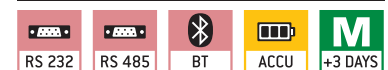

Model	Weighing range [Max] kg	Readout = Verification value [d] = [e] kg	Minimum load [Min] kg	Net weight approx. kg	Dimensions of weighing plate WxDxH mm	Price excl. of VAT ex works €	Options			
							Verification		DAkkS Calibr. Certificate	
							M III KERN	€	DKD KERN	€
Complete device consisting of the KERN KXS-TM display device and Weighing bridge KERN KXP V20 IP67										
BXS 600K-1SM	600	0,2	4	105	A 1000x1000x80	1350,-	965-230	132,-	963-130	165,-
BXS 600K-1M	600	0,2	4	135	B 1500x1250x80	1650,-	965-230	132,-	963-130	165,-
BXS 1.5T-4SM	1500	0,5	20	105	A 1000x1000x80	1350,-	965-230	132,-	963-130	165,-
BXS 1.5T-4M	1500	0,5	20	135	B 1500x1250x80	1650,-	965-230	132,-	963-130	165,-
BXS 3T-3M	3000	1	20	145	B 1500x1250x80	1600,-	965-232	320,-	963-132	440,-

Floor scale KERN BFS

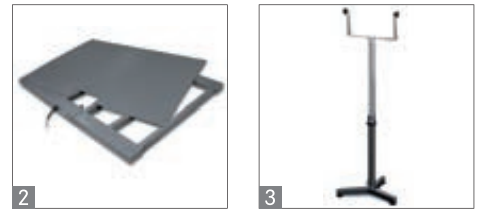

Note: For verified models the weighing bridge must be fixed to the floor. Optionally by two ascending ramps or two pairs of base plates or by a combination of these two options.

For verifiable models with weighing plate size **C**, **D** limited tare range 1/6 of [Max]
I Shipment via freight forwarder. Please ask for dimensions, gross weight, shipping costs

Floor scale with screwed on weighing plate (IP67), piece-counting function, 99 item memories and EC type approval [M]

Features

- **Industrial quality:** heavy version for tough usage in industrial applications
- **I Weighing bridge:** steel, lacquered, extremely resistant to bending due to material thickness, weighing plate size **C**, **D** corrugated steel plate welded, protection against dust and water splashes IP67, 4 silicone-coated steel load cells. Weighing bridge can also be delivered as components without the display device, KXP V20 IP67N, for details, see page 151
- **2 Weighing plate A, B screwed on from the top**, so it's easy to remove, hygienic and easy to clean
- **Easy levelling of the weighing bridge** as well as **access to the junction box** from above
- **Display device** with large keypad and 3 high-contrast LCD display for easy entry and reading of, e.g., tare weights, reference weights, limit values etc. when piece counting. The display device can also be delivered as a component without the weighing bridge, KERN KFS-TM

- **Benchtop stand incl. wall mount** for display device as standard
- **99 item memories for master data** such as reference weight, reference quantity, container weight (PRE-TARE) etc. when piece counting
- **Printout with date and time**
- **Totalising** of counting operations

Technical data

- Large backlit LCD display, digit height 16,5 mm
- Dimensions of display device WxDxH 260x150x65 mm
- Cable length of display device approx. 5 m
- Permissible ambient temperature -10 °C / 40 °C

Accessories

- **Protective working cover** over the display device standard. Can be re-ordered, scope of delivery: 5 items, KERN KFB-A02S05, € 35,-

- **Rechargeable battery pack internal**, operating time up to 40 h without backlight, charging time approx. 12 h, must be ordered at purchase, KERN KFS-A01, € 35,-
- **3 Stand** to elevate display device, height of stand 750–1000 mm, KERN BFS-A07, € 120,-
- **Pair of base plates** to fix the weighing bridge to the floor, for models with weighing plate size **A**, **B**, **C** KERN BFS-A06N, € 60,-
D KERN BFS-A10, € 60,-
- **Stable pit frame** for weighing bridge installation, allowing for easy access for models with weighing plate size **A** BxT 1085x1085 mm, KERN BFS-A03N, € 250,-
B BxT 1335x1585 mm, KERN BFS-A04N, € 280,-
C BxT 1585x1585 mm, KERN BFS-A08, € 300,-
- **Ascending ramp**, not included, for models with weighing plate size **A** WxDxH 1000x750x85 mm, KERN BFS-A01N, € 300,-
B WxDxH 1250x750x85 mm, KERN BFS-A02N, € 350,-
C WxDxH 1500x750x85 mm, KERN BFS-A09, € 420,-
D WxDxH 1500x750x121 mm, KERN BFS-A11, € 500,-
- **Cable with special length** 15 m, between display device and platform, must be ordered at purchase, KERN BFB-A03, € 160,-

STANDARD



OPTION



FACTORY



Model	Weighing range [Max] kg	Readout = Verification value [d] = [e] kg	Minimum load [Min] kg	Net weight approx. kg	Dimensions of weighing plate WxDxH mm	Price excl. of VAT ex works €	Options			
							Verification		DAKKS Calibr. Certificate	
							M III KERN	€	DKD KERN	€
Complete device consisting of the KERN KFS-TM display device and Weighing bridge KFP V20 IP67(N)										
BFS 600K-1SNM	600	0,2	4	105	A 1000x 1000x 85	1050,- ^I	965-230	132,-	963-130	165,-
BFS 600K-1NM	600	0,2	4	135	B 1500x 1250x 85	1450,- ^I	965-230	132,-	963-130	165,-
BFS 1T-4SNM	1500	0,5	10	105	A 1000x 1000x 85	1050,- ^I	965-230	132,-	963-130	165,-
BFS 1T-4NM	1500	0,5	10	135	B 1500x 1250x 85	1450,- ^I	965-230	132,-	963-130	165,-
BFS 3T-3NM	3000	1	20	135	B 1500x 1250x 85	1450,- ^I	965-232	320,-	963-132	440,-
BFS 3T-3LM	3000	1	20	160	C 1500x 1500x 80	1650,- ^I	965-232	320,-	963-132	440,-
BFS 6T-3M	6000	2	40	210	D 1500x 1500x 130	1950,- ^I	965-232	320,-	963-132	440,-

^I Price reduction

Floor scale KERN BFA

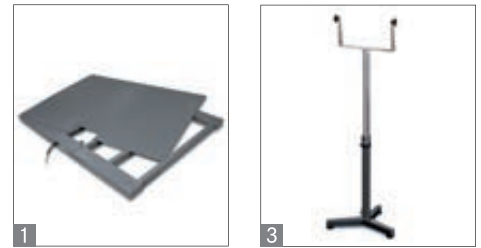
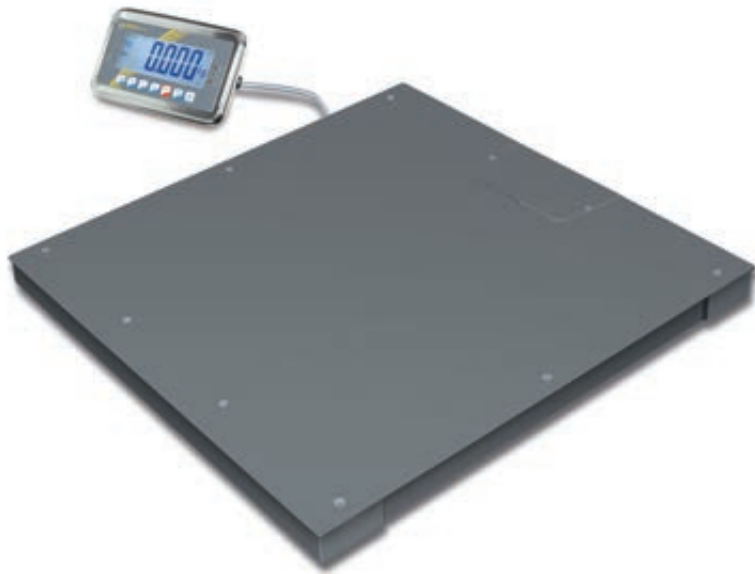

Note: For verified models the weighing bridge must be fixed to the floor. Optionally by two ascending ramps or two pairs of base plates or by a combination of these two options.

For verifiable models with weighing plate size **C**, **D** limited tare range 1/6 of [Max]

1 Shipment via freight forwarder. Please ask for dimensions, gross weight, shipping costs

Weighing bridge with screwed on weighing plate (IP67) and stainless steel display device (IP68), with EC type approval [M]

Features

- **Industrial quality:** heavy version for tough usage in industrial applications
- **1 Weighing bridge:** steel, lacquered, weighing plate size **C**, **D** corrugated steel plate welded, protection against dust and water splashes (IP67), 4 silicone-coated steel load cells. Weighing bridge can also be delivered as components without the display device, KXP V20 IP67 protection, details see page 151
- **2 Weighing plate screwed on from the top,** so it's easy to remove, hygienic and easy to clean
- **Easy levelling of the weighing bridge** as well as **access to the junction box** from above
- **Display device: KERN KFN-TM**, protection against dust and water splashes IP65 (only when using rechargeable battery pack)
- **Benchtop stand incl. wall mount** for display device as standard

Technical data

- Large backlit LCD display, digit height 52 mm
- Dimensions of display device WxDxH 266x165x96 mm
- Cable length of display device approx. 5 m
- **Rechargeable battery pack internal**, standard, operating time up to 50 h without backlight, charging time approx. 12 h KERN GAB-A04, **€ 40,-**
- Permissible ambient temperature -10 °C / 40 °C

Accessories

- **3 Stand** to elevate display device, height-adjustable, height of stand 750-1000 mm, KERN BFS-A07, **€ 120,-**
- **Pair of base plates** to fix the weighing bridge to the floor, for models with weighing plate size **A**, **B**, **C** KERN BFS-A06N, **€ 60,-**
D KERN BFS-A10, **€ 60,-**

- **Ascending ramp** for models with weighing plate size WxDxH **A** 1000x760x85 mm, KERN BFS-A01N, **€ 300,-**
B 1250x870x85 mm, KERN BFS-A02N, **€ 350,-**
C 1500x760x85 mm, KERN BFS-A09, **€ 410,-**
D 1500x750x121 mm, KERN BFS-A11, **€ 500,-**
- **4 Stable pit frame** for weighing bridge installation, allowing for easy access, for models with weighing plate size WxDxH **A** 1085x1085x80 mm, KERN BFS-A03N, **€ 250,-**
B 1335x1585x80 mm, KERN BFS-A04N, **€ 280,-**
C 1500x1500x95 mm, KERN BFS-A08, **€ 280,-**
- **Data interface RS-232**, interface cable included, approx. 1.5 m, must be ordered at purchase, KERN KFN-A01, **€ 95,-**
- **Large display** with superior display size, digit height 76 mm, WxDxH 541x55x180 mm, only in combination with data interface KERN KFN-A01, KERN YKD-A02, **€ 215,-**
- **Cable with special length** 15 m, between display device and platform, must be ordered at purchase, KERN BFB-A03, **€ 160,-**
- **Suitable printers** and further, extensive accessories from page 177 ff.

STANDARD

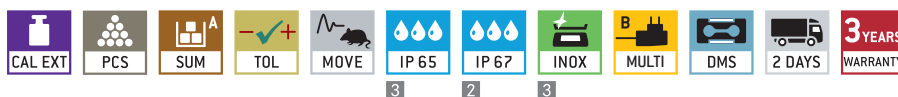

OPTION



FACTORY



Model	Weighing range [Max] kg	Readout = Verification value [d] = [e] kg	Minimum load [Min] kg	Net weight approx. kg	Dimensions of weighing plate WxDxH mm	Price excl. of VAT ex works €	Options			
							Verification		DAkkS Calibr. Certificate	
							M KERN	€	DKD KERN	€
BFA 600K-1SNM	600	0,2	4	105	A 1000x1000x85	1110,-	965-230	132,-	963-130	165,-
BFA 600K-1NM	600	0,2	4	135	B 1500x1250x85	1490,-	965-230	132,-	963-130	165,-
BFA 1T-4SNM	1500	0,5	10	105	A 1000x1000x85	1140,-	965-230	132,-	963-130	165,-
BFA 1T-4NM	1500	0,5	10	135	B 1500x1250x85	1540,-	965-230	132,-	963-130	165,-
BFA 3T-3NM	3000	1	20	135	B 1500x1250x85	1490,-	965-232	320,-	963-132	440,-
BFA 3T-3LM	3000	1	20	160	C 1500x1500x80	1700,-	965-232	320,-	963-132	440,-
BFA 6T-3M	6000	2	40	210	D 1500x1500x130	2040,-	965-232	320,-	963-132	440,-

Note: For applications that require verification, please order verification at the same time, initial verification at a later date is not possible. Verification at the factory, we need to know the full address of the location of use.

Floor scale KERN BBB



Note for information on further useful functions for this range, please see pages 6, 7, 149



PREMIUM
★ ★ ★

Note: For verified models the weighing bridge must be fixed to the floor. Optionally by two ascending ramps or two pairs of base plates or by a combination of these two options.

❗ Shipment via freight forwarder. Please ask for dimensions, gross weight, shipping costs

Weighing bridge with screwed on weighing plate (IP68) and touchscreen display (IP66) with extensive industrial functionality

Features

- **Industrial quality:** heavy version for tough usage in industrial applications
- **1 Weighing bridge:** steel, lacquered, weighing plate size **C** **D**, corrugated steel plate, protection against dust and water splashes (IP67), 4 silicone-coated steel load cells. Weighing bridge can also be delivered as components without the display device, KXP V20 IP67 protection, details see page 150
- **2 Weighing plate A B** screwed on from the top, so it's easy to remove, hygienic and easy to clean
- **Easy levelling of the weighing bridge** as well as **access to the junction box** from above
- **3 Stainless steel touchscreen display KERN KEN-TM** for easy entry and reading e. g. item data, tare weights, reference weights, limit values, etc. Protection against dust and water splashes IP66, details see page 149
- **Benchtop stand incl. wall mount** for display device as standard
- 1 GB large internal memory, 64 MB large RAM memory

- **Alibi memory:** paperless archive of weighing results, details see page 214
- **Up to four platforms can be connected**
- **Password protection**

Technical data

- Bright TFT touch display with digit height 21 mm, screen diagonal 5,7" (approx. 145 mm), WxH 115x86 mm
- Dimensions of display device WxDxH 282x200x76 mm
- Cable length of display device approx. 5 m
- Permissible ambient temperature -10 °C / 40 °C

Accessories

- **Interface cable RS-232**, cable length approx. 2 m, KERN KEN-A01, **€ 80,-**
- **Interface cable USB**, cable length approx. 1,7 m, KERN KEN-A02, **€ 140,-**
- **Stand**, height-adjustable, large three-legged adjustable foot, height of stand 750 - 1000 mm, must be ordered at purchase, KERN YKP-02, **€ 210,-**
- **Pair of base plates** to fix the weighing

bridge to the floor, for models with weighing plate size

- A, B, C** KERN BFS-A06N, **€ 60,-**
- D** KERN BFS-A10, **€ 60,-**
- **Ascending ramp** for models with weighing plate size WxDxH
 - A** 1000x760x85 mm, KERN BFS-A01N, **€ 300,-**
 - B** 1250x870x85 mm, KERN BFS-A02N, **€ 350,-**
 - C** 1500x760x85 mm, KERN BFS-A09, **€ 410,-**
 - D** 1500x750x121 mm, KERN BFS-A11, **€ 500,-**
- **B Stable pit frame** for models with weighing plate size WxDxH
 - A** 1085x1085x80 mm, KERN BFS-A03N, **€ 250,-**
 - B** 1335x1585x80 mm, KERN BFS-A04N, **€ 280,-**
 - C** 1500x1500x95 mm, KERN BFS-A08, **€ 280,-**
- **Large display** with superior display size, KERN KET-A06, **€ 1450,-**
- **Cable with special length** 15 m, between display device and platform, for verified models, this must be ordered at the time of purchase, KERN BFB-A03, **€ 160,-**
- **Analogue/Digital converter**, KERN KET-A01, **€ 350,-**
- **Analogue module**, KERN KEN-A06, **€ 350,-**
- **Relay output**, KERN KEN-A07, **€ 180,-**
- **I/O digital control outputs (8 in/out)**, KERN KEN-A08, **€ 600,-**
- **Module Profibus**, KERN KEN-A09, **€ 250,-**
- **Suitable printers** and further, extensive accessories from page 177 ff.

STANDARD

CAL EXT MEMORY RS 232 USB SWITCH LAN PCS SUM PERCENT TOL MOVE IP 67 INOX DMS 230 V 23 DAYS WARRANTY 3 YEARS

OPTION FACTORY

DAkKS +3 DAYS DUAL +3 DAYS M

Model	Weighing range [Max] kg	Readout = Verification value [d] = [e] kg	Minimum load [Min] kg	Net weight approx. kg	Dimensions of weighing plate WxDxH mm	Price excl. of VAT ex works €	Options			
							Verification		DAkkS Calibr. Certificate	
							M KERN	€	DKD KERN	€
BBB 600K-1SNM	600	0,2	4	85	A 1000x1000x85	3500,-	965-230	132,-	963-130	165,-
BBB 600K-1NM	600	0,2	4	135	B 1500x1250x85	3900,-	965-230	132,-	963-130	165,-
BBB 1T-4SNM	1500	0,5	10	105	A 1000x1000x85	3500,-	965-230	132,-	963-130	165,-
BBB 1T-4NM	1500	0,5	10	135	B 1500x1250x85	3900,-	965-230	132,-	963-130	165,-
BBB 3T-3NM	3000	1	20	135	B 1500x1250x85	3900,-	965-232	320,-	963-132	440,-
BBB 3T-3LM	3000	1	20	160	C 1500x1500x80	4100,-	965-232	320,-	963-132	440,-
BBB 6T-3M	6000	2	40	210	D 1500x1500x130	4500,-	965-232	320,-	963-132	440,-

Note: For applications that require verification, please order verification at the same time, initial verification at a later date is not possible. Verification at the factory, we need to know the full address of the location of use.

Floor scale KERN BAN

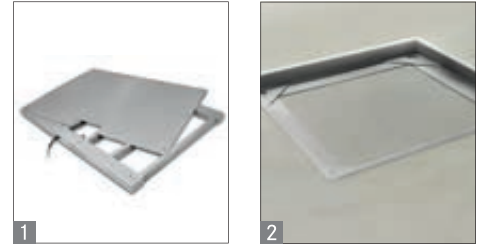

Note: For verified models the weighing bridge must be fixed to the floor. Optionally by two ascending ramps or two pairs of base plates or by a combination of these two options.

■ Shipment via freight forwarder. Please ask for dimensions, gross weight, shipping costs

Stainless steel floor scale with complete dust and spray protection to IP68, extra large weighing bridge and EC type approval [M]

Features

- **Industrial quality:** heavy version for tough usage in industrial applications
- **■ Weighing bridge:** made entirely of stainless steel, extremely resistant to bending due to material thickness, protection against dust and water splashes IP68, 4 welded stainless steel load cells. Weighing bridge can also be delivered as components without the display device, KFP V40, details see page 153
- Your support in a **HACCP**-compliant quality system
- **Weighing plate screwed on from the top with stainless steel screws**, so it's easy to remove, hygienic and easy to clean
- **Easy levelling of the weighing bridge** as well as **access to the junction box** from above
- **Display device:** stainless steel, protection against dust and water splashes IP68, hygienic and easy to clean, with integrated power supply and superior display size. The display device can also be delivered as a component without the weighing bridge, KERN KXS-TM, details see page 148

- **Benchtop stand incl. wall mount** for display device as standard
- **Weighing with tolerance range (checkweighing):** A visual and audible signal assists with portion division, dispensing or grading or the rapid checking of items on palettes
- **Totalising** of weights and piece counts

Technical data

- Large backlit LCD display, digit height 55 mm
- Dimensions of display device WxDxH 232x170x80 mm
- Cable length of display device approx. 5 m
- Weighing plate dimensions WxDxH
 - A 1000x1000x80 mm
 - B 1500x1250x80 mm
- Permissible ambient temperature -10 °C / 40 °C

Accessories

- **Rechargeable battery pack internal**, operating time up to 80 h without backlight, charging time approx. 12 h, must be ordered at purchase, KERN GAB-A04, € 40,-

- **Stand**, stainless steel, height-adjustable, large three-legged adjustable foot, height of stand 750-1000 mm, must be ordered at purchase, KERN YKP-01, € 360,-
- **Foot switch**, must be ordered at purchase, details see page 182, KERN KXS-A03, € 70,-
- **Ascending ramp** including fixing board between weighing bridge and ascending ramp, for models with weighing plate size
 - A WxDxH 1250x750x85 mm, KERN BFN-A01, € 1150,-
 - B WxDxH 1000x750x85 mm, KERN BFN-A05, € 1030,-
- **Pair of base plates** to fix the weighing bridge to the floor, KERN BFN-A03, € 70,-
- **■ Stable pit frame**, stainless steel, dimensions WxDxH 1335x1585x80 mm, for models with weighing plate size ■, KERN BFN-A02, € 830,-
- **Data interface RS-232**, interface cable included, approx. 1.5 m, must be ordered at purchase, KERN KXS-A04, € 40,-
- **Data interface RS-485**, must be ordered at purchase, KERN KXS-A01, € 85,-
- **Bluetooth data interface** for wireless data transfer to PC or tablets, must be ordered at purchase, KERN KXS-A02, € 110,-
- **Foot switch**, must be ordered at purchase, for details see page 182, KERN KXS-A03, € 70,-
- **Cable with special length** 15 m, between display device and platform, for verified models, this must be ordered at the time of purchase, KERN BFB-A03, € 160,-
- **Suitable printers** see page 177

STANDARD



OPTION



FACTORY



Model	Weighing range [Max] kg	Readout = Verification value [d] = [e] kg	Minimum load [Min] kg	Net weight approx. kg	Dimensions of weighing plate WxDxH mm	Price excl. of VAT ex works €	Options			
							Verification		DAkKS Calibr. Certificate	
							■ M ■ KERN	€	DKD KERN	€
BAN 600K-1SM	600	0,2	20	86	1000x1000x80	3050,-	965-230	132,-	963-130	165,-
BAN 1T-4SM	1500	0,5	20	86	1000x1000x80	3050,-	965-230	132,-	963-130	165,-
BAN 1T-4M	1500	0,5	20	136	1500x1250x80	3750,-	965-230	132,-	963-130	165,-
BAN 3T-3M	3000	1	20	136	1500x1250x80	3750,-	965-232	320,-	963-132	440,-

Note: For applications that require verification, please order verification at the same time, initial verification at a later date is not possible. Verification at the factory, we need to know the full address of the location of use.

Floor scale KERN BFN

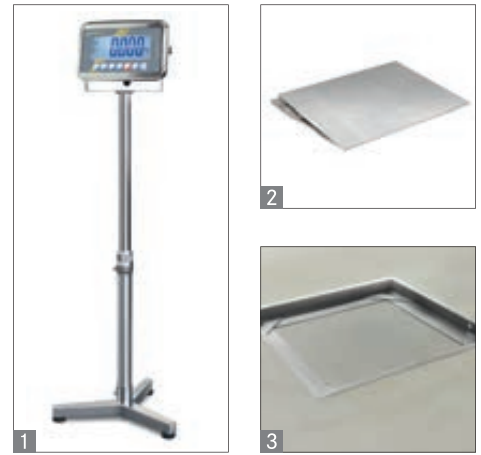

Stainless steel weighing bridge with screwed on weighing plate (IP68) and stainless steel display device (IP65), with EC type approval [M]

Features

- **Industrial quality:** heavy version for tough usage in industrial applications
- **4 Weighing bridge:** made entirely of stainless steel, extremely resistant to bending due to material thickness, protection against dust and water splashes IP68, 4 welded stainless steel load cells. Weighing bridge can also be delivered as components without the display device, KERN KFP V40, details see page 153
- Your support in a **HACCP**-compliant quality system
- **Weighing plate screwed on from the top with stainless steel screws**, so it's easy to remove, hygienic and easy to clean
- **Easy levelling of the weighing bridge** as well as **access to the junction box** from above
- **5 Display device KERN KFN-TM:** stainless steel, protection against dust and water splashes IP65, hygienic and easy to clean. The display device can also be delivered as a component without the weighing bridge, KERN KFN-TM, details see page 148
- **Benchtop stand incl. wall mount** for display device as standard

- **Weighing with tolerance range (checkweighing):** Input of an upper/lower limit value. A visual and audible signal assists with portioning dispensing or grading
- **Totalising** of weights and piece counts

Technical data

- Large backlit LCD display, digit height 52 mm
- Weighing plate dimensions WxDxH
 - A** 1000x1000x80 mm
 - B** 1500x1250x80 mm
- Dimensions of display device WxDxH 270x175x96 mm
- Rechargeable battery pack internal, standard, operating time up to 35 h without backlight, charging time approx. 12 h
- Cable length of display device approx. 5 m
- Permissible ambient temperature -10 °C / 40 °C

Accessories

- **1 Stand** to elevate display device, stainless steel, height-adjustable, height of stand 750-1000 mm, KERN BFN-A04, **€ 280,-**

Note: For verified scales the weighing bridge must be fixed to the floor. Optionally, with an access ramp, a footplate pair or a pit frame

1 Shipment via freight forwarder. Please ask for dimensions, gross weight, shipping costs

- **2 Ascending ramp**, stainless steel, incl. attachment plate to fix it to the weighing bridge, for models with weighing plate size
 - A** WxDxH 1000x750x85 mm, KERN BFN-A05, **€ 1030,-**
 - B** WxDxH 1250x750x85 mm, KERN BFN-A01, **€ 1150,-**
- **Pair of base plates** to fix the weighing bridge to the floor, KERN BFN-A03, **€ 70,-**
- **3 Stable pit frame** for weighing bridge installation, allowing for easy access, stainless steel, dimensions WxDxH 1335x1585x80 mm, only for models with weighing plate size **B**, KERN BFN-A02, **€ 830,-**
- **Data interface RS-232**, interface cable included, must be ordered at purchase, KERN KFN-A01, **€ 95,-**
- **Cable with special length 15 m**, between display device and platform, for verified models, this must be ordered at the time of purchase, KERN BFB-A03, **€ 160,-**
- **Suitable printers** and further, extensive accessories from page 177 ff.

STANDARD



OPTION



FACTORY



Model	Weighing range [Max] kg	Readout = Verification value [d] = [e] kg	Minimum load [Min] kg	Net weight approx. kg	Dimensions of weighing plate WxDxH mm	Price excl. of VAT ex works €	Options			
							Verification		DAkkS Calibr. Certificate	
							M KERN	€	DKD KERN	€
BFN 600K-1SM	600	0,2	4	96,4	1000x1000x80	2650,-	965-230	132,-	963-130	165,-
BFN 1T-4SM	1500	0,5	10	96,4	1000x1000x80	2650,-	965-230	132,-	963-130	165,-
BFN 1.5T0.5M	1500	0,5	10	135	1500x1250x80	3350,-	965-230	132,-	963-130	165,-
BFN 3T-3M	3000	1	20	143	1500x1250x80	3350,-	965-232	320,-	963-132	440,-

Floor scale KERN BBN



Note for information on further useful functions for this range, please see pages 6, 7, 149



PREMIUM
★ ★ ★

Note: For verified models the weighing bridge must be fixed to the floor. Optionally by two ascending ramps or two pairs of base plates or by a combination of these two options.

Shipment via freight forwarder. Please ask for dimensions, gross weight, shipping costs

Stainless steel weighing bridge with screwed on weighing plate (IP68) and touchscreen display (IP66) with extensive industrial functionality

Features

- **Industrial quality:** heavy version for tough usage in industrial applications
- **1 Weighing plate screwed on from the top with stainless steel screws**, so it's easy to remove, hygienic and easy to clean
- **2 Weighing bridge:** made entirely of stainless steel, extremely resistant to bending due to material thickness, protection against dust and water splashes IP68, 4 welded stainless steel load cells. Weighing bridge can also be delivered as components without the display device, KFP V40, details see page 153
- **Easy access to the junction box** from the top
- **Display device:** Stainless steel, touchscreen, with alphanumeric keyboard for easy entry and reading of, for example, item data, tare weights, reference weights, limit values, etc. Protection against dust and water splashes IP66. The display device can also be delivered as a component without the weighing bridge, KERN KEN-TM, details, see page 149
- **1 GB large internal memory**, 64 MB large RAM memory

- **Alibi memory:** paperless archive of weighing results
- **Up to four platforms can be connected**
- **Password protection**
- **Benchtop stand incl. wall mount** for display device as standard

Technical data

- Bright TFT touch display with digit height 21 mm, screen diagonal 5,7" (approx. 145 mm), WxH 115x86 mm
- Dimensions of display device WxDxH 282x200x76 mm
- Cable length of display device approx. 5 m
- Permissible ambient temperature -10 °C / 40 °C

Accessories

- **Stand** to elevate display device, stainless steel, height-adjustable, large three-legged feet, height of stand 750-1000 mm, must be ordered at purchase, KERN YKP-01, **€ 360,-**
- **Pair of base plates** to fix the weighing bridge to the floor, KERN BFN-A03, **€ 70,-**

- **Ascending ramp**, for models with weighing plate size
 - A** WxDxH 1000x750x85 mm, KERN BFN-A05, **€ 1030,-**
 - B** WxDxH 1250x750x85 mm, KERN BFN-A01, **€ 1150,-**
- **3 Stable pit frame**, stainless steel, dimensions WxDxH 1085x1085x80 mm, for models with weighing plate size **B**, must be ordered at purchase, KERN BFN-A02, **€ 830,-**
- **Interface cable RS-232**, cable length approx. 2 m, KERN KEN-A01, **€ 80,-**
- **Interface cable USB**, cable length approx. 1,7 m, KERN KEN-A02, **€ 140,-**
- **Large display** with superior display size, KERN KET-A06, **€ 1450,-**
- **Cable with special length** 15 m, between display device and platform, must be ordered at purchase, KERN BFB-A03, **€ 160,-**
- **Suitable printers** and further, extensive accessories from page 177 ff.

10

STANDARD

OPTION FACTORY

CAL EXT MEMORY RS 232 USB SWITCH LAN PCS SUM PERCENT TOL MOVE IP 68 INOX 230 V DMS 23 DAYS WARRANTY 3 YEARS DAkkS +3 DAYS DUAL +3 DAYS M

Model	Weighing range [Max] kg	Readout = Verification value [d] = [e] kg	Minimum load [Min] kg	Net weight approx. kg	Dimensions of weighing plate WxDxH mm	Price excl. of VAT ex works €	Options			
							Verification		DAkkS Calibr. Certificate	
							M KERN	€	DKD KERN	€
BBN 600K-1SM	600	0,2	4	85	A 1000x1000x80	5100,-	965-230	132,-	963-130	165,-
BBN 1T-4SM	1500	0,5	10	85	A 1000x1000x80	5100,-	965-230	132,-	963-130	165,-
BBN 1T-4M	1500	0,5	10	135	B 1500x1250x80	5800,-	965-230	132,-	963-130	165,-
BBN 3T-3M	3000	1	20	135	B 1500x1250x80	5800,-	965-232	320,-	963-132	440,-

Note: For applications that require verification, please order verification at the same time, initial verification at a later date is not possible. Verification at the factory, we need to know the full address of the location of use.

Weighing beams KERN UFA



Highly versatile weighing beams (IP67) for large loads to 6 t

Features

- Flexible solution for weighing large, bulky or long items
- **High mobility:** thanks to battery operation (optional) and compact, flat construction, it is suitable for use in several locations (production, warehouse, dispatch department etc.)
- **Weighing beams:** steel, lacquered, protection against dust and water splashes (IP67), 4 silicone-coated stainless load cells. Weighing beams can also be delivered as components without the display device, KFA V20, details see page 152
- **Sturdy handles** for transporting the weighing beams
- **Models with suffix-L:** Each weighing beam has a roller and handle for easy transport of the scale
- **Display device:** KERN KFB-TM, details see page 147
- **Benchtop stand incl. wall mount** for display device as standard
- **Totalising** of weights and piece counts

Technical data

- Large backlit LCD display, digit height 52 mm
- Dimensions of display device WxDxH 250x160x130 mm
- Cable length of display device approx. 5 m
- Cable length weighing beams approx. 2,5 m
- Permissible ambient temperature -10 °C / 40 °C

Accessories

- **Protective working cover** over the display device standard. Can be re-ordered, scope of delivery: 5 items, KERN KFB-A02S05, € 35,-
- **Stand** to elevate display device, height-adjustable, height of stand 750-1000 mm, KERN BFS-A07, € 120,-
- **Rechargeable battery pack internal**, operating time up to 35 h, charging time approx. 10 h, must be ordered at purchase, KERN KFB-A01, € 35,-

Shipment via freight forwarder. Please ask for dimensions, gross weight, shipping costs

- **Signal lamp** for visual support of weighing with tolerance range. For details see page 181, KERN CFS-A03, € 250,-
- **Large display with superior display size**, digit height 76 mm. WxDxH 541x55x180 mm, for details see page 181, KERN YKD-A02, € 215,-
- **Y-cable** for parallel connection of two terminal devices to the RS-232 interface on the scale, e.g. signal lamp and printer, KERN CFS-A04, € 35,-
- **Cable with special length 15 m**, between display device and platform, must be ordered at purchase, KERN BFB-A03, € 150,-
- **Suitable printers** see page 177 ff.

STANDARD



OPTION



FACTORY



Model	Weighing range [Max] kg	Readout [d] kg	Reproducibility kg	Linearity kg	Net weight per beam kg	Dimensions of weighing plate WxDxH mm	Price excl. of VAT ex works €	Options DAkkS Calibr. Certificate	
								DKD KERN	€
UFA 1.5T0.5	1500	0,5	0,5	± 1	16	1200x120x100	850,-	963-130	165,-
UFA 3T1	3000	1	1	± 2	16	1200x120x100	850,-	963-132	440,-
UFA 3T-3L	3000	1	1	± 2	40	1200x163x80	995,-	963-132	440,-
UFA 6T-3	6000	2	2	± 4	30	2000x120x85	1190,-	963-132	440,-
UFA 6T-3L	6000	2	2	± 4	60	2100x160x85	1490,-	963-132	440,-

Pallet scale KERN UFB

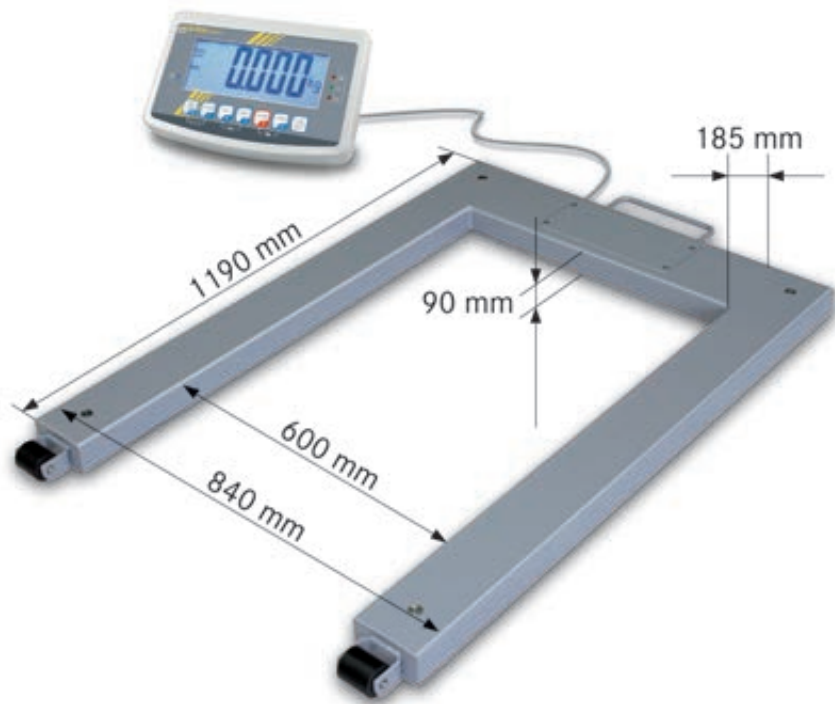

Pallet scale with steel load support (IP67) and EC type approval [M]

Features

- **High mobility:** thanks to battery operation (optional) and compact, flat construction, it is suitable for use in several locations (production, warehouse, dispatch department etc.)
- **Load support:** steel, lacquered, protection against dust and water splashes (IP67), 4 silicone-coated stainless load cells. Also available as component without the display device, KERN KFU-V20, see page 152
- **Display device:** KERN KFB-TM, details see page 147
- **2 rollers and handle** for easy transport of the scale
- **Weighing with tolerance range (checkweighing):** Input of an upper/lower limit value. A visual and audible signal assists with portion division, dispensing or grading or the rapid checking of items on pallets
- Counting system: A counting scale can be connected using the data interface, and this can be used to create a high-capacity counting system for counting the very small parts in largest quantities
- **Totalising** of weights and piece counts

Technical data

- Large backlit LCD display, digit height 52 mm
- Dimensions of display device WxDxH 250x160x58 mm
- Cable length of display device approx. 5 m
- Net weight approx. 51 kg
- Permissible ambient temperature -10 °C / 40 °C

Accessories

- **Protective working cover** over the display device standard. Can be re-ordered, scope of delivery: 5 items, KERN KFB-A02S05, € 35,-
- **Stand** to elevate display device, height-adjustable, height of stand 750-1000 mm, KERN BFS-A07, € 120,-
- **Rechargeable battery pack internal**, operating time up to 35 h, charging time approx. 12 h, must be ordered at purchase, KERN KFB-A01, € 35,-
- **Signal lamp** for visual support of weighing with tolerance range. For details see page 181, KERN CFS-A03, € 250,-

Limited tare range with verifiable models (1/6 from [Max])

Shipment via freight forwarder. Please ask for dimensions, gross weight, shipping costs

- **Y-cable** for parallel connection of two terminal devices to the RS-232 interface on the scale, e.g. signal lamp and printer, KERN CFS-A04, € 35,-
- **Large display with superior display size**, digit height 76 mm, WxDxH 541x55x180 mm, details see page 181, KERN YKD-A02, € 215,-
- **Cable with special length 15 m**, between display device and platform, for verified models which must be ordered at the time of purchase, KERN BFB-A03, € 150,-
- **Suitable printers** see page 177 ff.

STANDARD



OPTION



FACTORY



Model	Weighing range [Max] kg	Readout = Verification value [d] = [e] kg	Minimum load [Min] kg	Price excl. of VAT ex works €	Options			
					Verification		DAkkS Calibr. Certificate	
					MII KERN	€	DKD KERN	€
UFB 600K200M	600	0,2	4	890,-	965-230	132,-	963-130	165,-
UFB 1.5T0.5M	1500	0,5	10	890,-	965-230	132,-	963-130	165,-

Note: For applications that require verification, please order verification at the same time, initial verification at a later date is not possible. Verification at the factory, we need to know the full address of the location of use.

Pallet scale KERN UFC

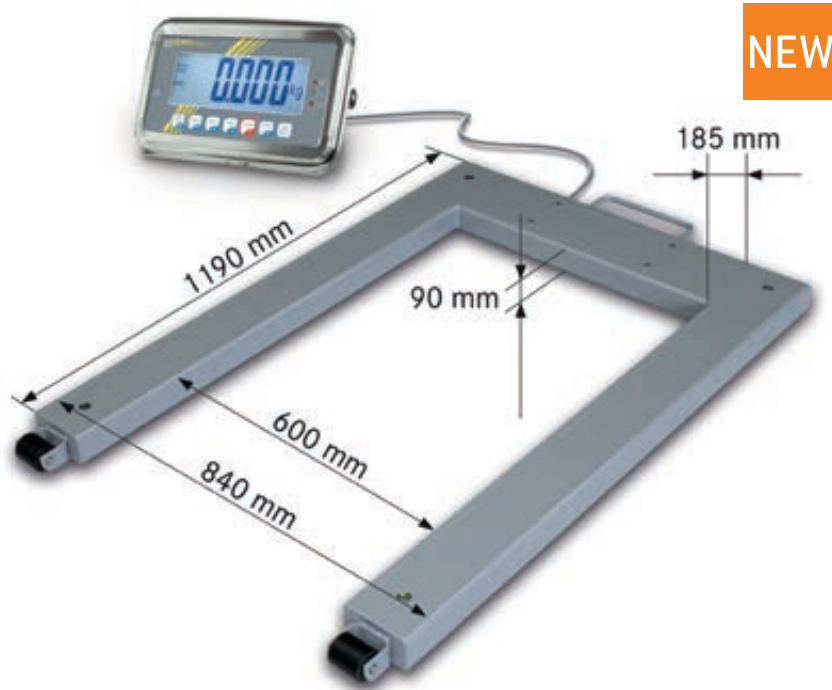

Limited tare range with verifiable models (1/6 from [Max])

Shipment via freight forwarder. Please ask for dimensions, gross weight, shipping costs

Pallet scale with steel load support (IP67) and stainless steel display device (IP65), with EC type approval [M]

Features

- **High mobility:** thanks to rechargeable battery operation (optional), compact, lightweight construction, it is suitable for the use in several locations
- **Load support:** steel, lacquered, protection against dust and water splashes (IP67), 4 silicone-coated stainless load cells. Also available as component without the display device, KERN KFU-V20, see page 152
- **2 rollers and handle** for easy transport of the scale
- **Display device:** KERN KFN-TM, details see page 148
- **Weighing with tolerance range (checkweighing):** A visual and audible signal assists with portion division, dispensing or grading or the rapid checking of items on palettes
- Counting system: A counting scale can be connected using the data interface, and this can be used to create a high-capacity counting system for counting the very small parts in largest quantities
- **Totalising** of weights and piece counts

Technical data

- Large backlit LCD display, digit height 52 mm
- Dimensions of display device WxDxH 266x165x96 mm
- Cable length of display device approx. 5 m
- Net weight approx. 52 kg
- Permissible ambient temperature -10 °C / 40 °C

Accessories

- **Stand** to elevate display device, height-adjustable, height of stand 750-1000 mm, KERN BFS-A07, € 120,-
- **Rechargeable battery pack internal**, operating time up to 35 h without backlight, charging time approx. 12 h, KERN GAB-A04, € 40,-
- **Data interface RS-232**, interface cable included, must be ordered at purchase, KERN KFN-A01, € 95,-
- **Y-cable** for parallel connection of two terminal devices to the RS-232 interface on the scale, e.g. signal lamp and printer, KERN CFS-A04, € 35,-

- **Signal lamp** for visual support of weighing with tolerance range, only in combination with data interface KERN KFN-A01, for details see page 181, KERN CFS-A03, € 250,-
- **Large display** with superior display size, digit height 76 mm, WxDxH 541x55x180 mm, details see page 181, KERN YKD-A02, € 215,-
- **Cable with special length** 15 m, between display device and platform, must be ordered at purchase, KERN BFB-A03, € 160,-
- **Suitable printers** see page 177 ff.

STANDARD



OPTION



FACTORY



Model	Weighing range [Max] kg	Readout = Verification value [d] = [e] kg	Minimum load [Min] kg	Price excl. of VAT ex works €	Options			
					Verification		DAkkS Calibr. Certificate	
					M KERN	€	DKD KERN	€
UFC 600K-1M	600	0,2	4	1280,-	965-230	132,-	963-130	165,-
UFC 1T-1M	1500	0,5	10	1280,-	965-230	132,-	963-130	165,-

Note: For applications that require verification, please order verification at the same time, initial verification at a later date is not possible. Verification at the factory, we need to know the full address of the location of use.

Pallet scale KERN UFN



- 1 Limited tare range with verifiable models (1/6 from [Max])
- 1 Shipment via freight forwarder. Please ask for dimensions, gross weight, shipping costs

Drive-through scale (IP67) with XXL display device and EC type approval [M]

Features

- **High mobility:** thanks to battery operation and compact, flat construction, it is suitable for use in several locations (production, warehouse, dispatch department etc.)
- **Load support:** made entirely of stainless steel, extremely resistant to bending due to material thickness, protection against dust and water splashes IP67, 4 silicone-coated stainless load cells. Weighing bridge can also be delivered as components without the display device, KERN KFU-V30, see page 152
- Your support in a **HACCP**-compliant quality system
- **Suitable for the ever-increasing hygienic requirements in the food industry**
- **Display device KERN KFN-TM**, stainless steel, for details see page 148
- **2 rollers and handle** for easy transport of the scale

- **Hold function:** When the weighing conditions are unstable, a stable weight is calculated determining an average value
- **Weighing with tolerance range (checkweighing):** Input of an upper/lower limit value. A visual and audible signal assists with portioning dispensing or grading
- **Totalising** of weights

Technical data

- Large backlit LCD display, digit height 52 mm
- Dimensions of display device WxDxH 266x165x96 mm
- Cable length of display device approx. 5 m
- Net weight approx. 54 kg
- Permissible ambient temperature -10 °C / 40 °C

Accessories

- **Stand** to elevate display device, stainless steel, height-adjustable, height of stand 750-1000 mm, KERN BFN-A04, **€ 280,-**
- **Rechargeable battery pack internal**, standard, operating time up to 35 h without backlight, charging time approx. 10 h, can be retrofitted, KERN GAB-A04, **€ 40,-**
- **Data interface RS-232**, interface cable included, must be ordered at purchase, KERN KFN-A01, **€ 95,-**
- **Large display** with superior display size, digit height 76 mm, WxDxH 541x55x180 mm, only in combination with data interface KERN KFN-A01, **€ 95,-** for details see page 181, KERN YKD-A02, **€ 215,-**
- **Cable with special length 15 m**, between display device and platform, for verified models, this must be ordered at the time of purchase, KERN BFB-A03, **€ 150,-**
- **Suitable printers** see page 177 ff.

STANDARD



OPTION



FACTORY

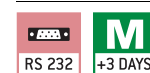

Model	Weighing range [Max] kg	Readout = Verification value [d] = [e] kg	Minimum load [Min] kg	Net weight approx. kg	Price excl. of VAT ex works €	Options			
						Verification		DAkkS Calibr. Certificate	
						KERN	€	DKD KERN	€
KERN UFN 600K200IPM	600	0,2	4	52	1700,-	965-230	132,-	963-130	165,-
KERN UFN 1.5T0.5IPM	1500	0,5	10	54	1700,-	965-230	132,-	963-130	165,-

Note: For applications that require verification, please order verification at the same time, initial verification at a later date is not possible. Verification at the factory, we need to know the full address of the location of use.

Drive-through scale KERN NFB

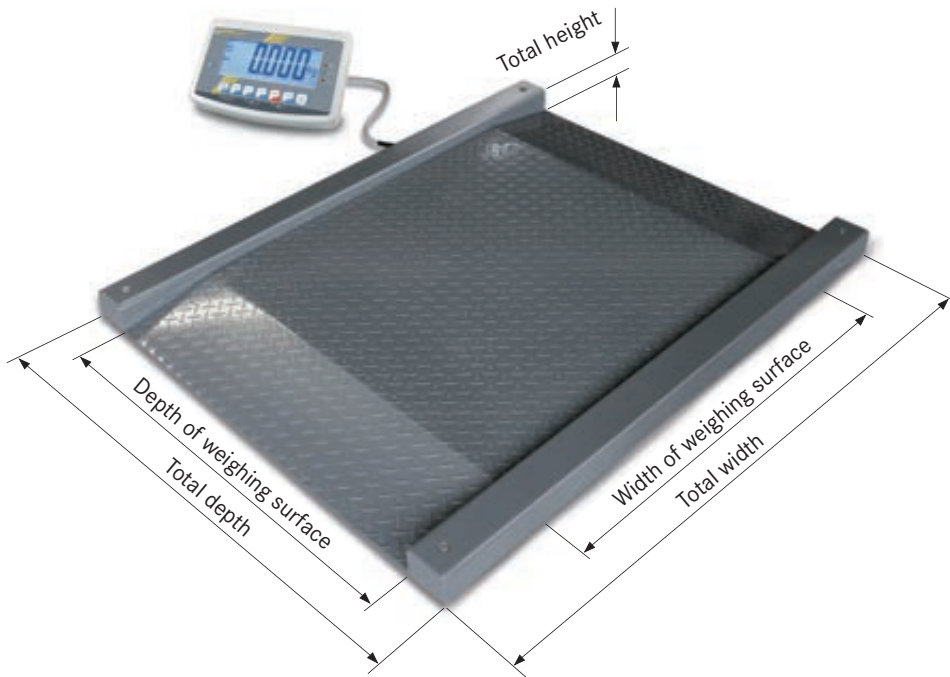

Note: For verified scales the weighing bridge must be fixed to the floor with a base plate pair

Limited tare range with verifiable models (1/6 from [Max])

Shipment via freight forwarder. Please ask for dimensions, gross weight, shipping costs

Drive-through scale (IP67) with XXL display device and EC type approval [M]

Features

- **Robust drive-through scale** for rapid weighing of e.g. wire cage trolleys, shelf trolleys, container trolleys, storage trolleys, sack trucks, transpallets, mobile containers, containers refuse etc.
- **Weighing bridge:** anti-slip corrugated steel plate, lacquered, protection against dust and water splashes (IP67), 4 silicone-coated stainless load cells. Also available as component without the display device, KERN KFD-V30, see page 151
- **Display device KERN KFB-TM**, details see page 147

Technical data

- Large backlit LCD display, digit height 52 mm
- Overall dimensions WxDxH
 - A 1600x1200x78 mm
 - B 1800x1400x78 mm

- Overall dimensions, without access ramps (Drive-through width and depth) WxD
 - A 1000x1000 mm
 - B 1200x1200 mm
- Dimensions of display device WxDxH 250x160x58 mm
- Cable length of display device approx. 5 m
- Permissible ambient temperature -10 °C / 40 °C

Accessories

- **Protective working cover** over the display device standard. Can be re-ordered, scope of delivery: 5 items, KERN KFB-A02S05, € 35,-
- **Stand** to elevate display device, height of stand approx. 750-1000 mm, KERN BFS-A07, € 120,-
- **Rechargeable battery pack internal**, operating time up to 35 h without backlight, charging time approx. 10 h, must be ordered at purchase, KERN KFB-A01, € 35,-

- **Pair of base plates** to fix the weighing bridge to the floor, KERN BFS-A06, € 60,-
- **Y-cable** for parallel connection of two terminal devices to the RS-232 interface on the scale, e.g. signal lamp and printer, KERN CFS-A04, € 35,-
- **Signal lamp** for visual support of weighing with tolerance range. For details see page 181, KERN CFS-A03, € 250,-
- **Large display with superior display size**, digit height 76 mm, WxDxH 541x55x180 mm, for details see page 181, KERN YKD-A02, € 215,-
- **Cable with special length 15 m**, between display device and platform, for verified models, this must be ordered at the time of purchase, KERN BFB-A03, € 150,-
- **Suitable printers** and further, extensive accessories from page 177 ff.

STANDARD



OPTION



FACTORY



Model	Weighing range [Max] kg	Readout = Verification value [d] = [e] kg	Minimum load [Min] kg	Net weight approx. kg	Weighing plate	Price excl. of VAT ex works €	Options			
							Verification		DAkkS Calibr. Certificate	
							M III KERN	€	DKD KERN	€
NFB 600K200M	600	0,2	4	131	A	1290,-	965-230	132,-	963-130	165,-
NFB 600K200LM	600	0,2	4	156	B	1450,-	965-230	132,-	963-130	165,-
NFB 1.5T0.5M	1500	0,5	10	122	A	1290,-	965-230	132,-	963-130	165,-
NFB 1.5T0.5LM	1500	0,5	10	150	B	1460,-	965-230	132,-	963-130	165,-

Note: For applications that require verification, please order verification at the same time, initial verification at a later date is not possible. Verification at the factory, we need to know the full address of the location of use.

Drive-through scale KERN NBB

NEW

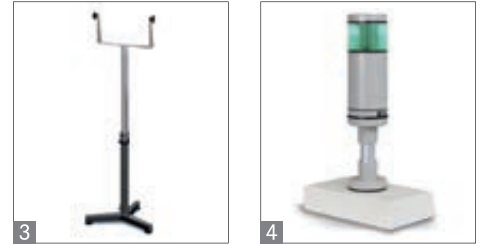
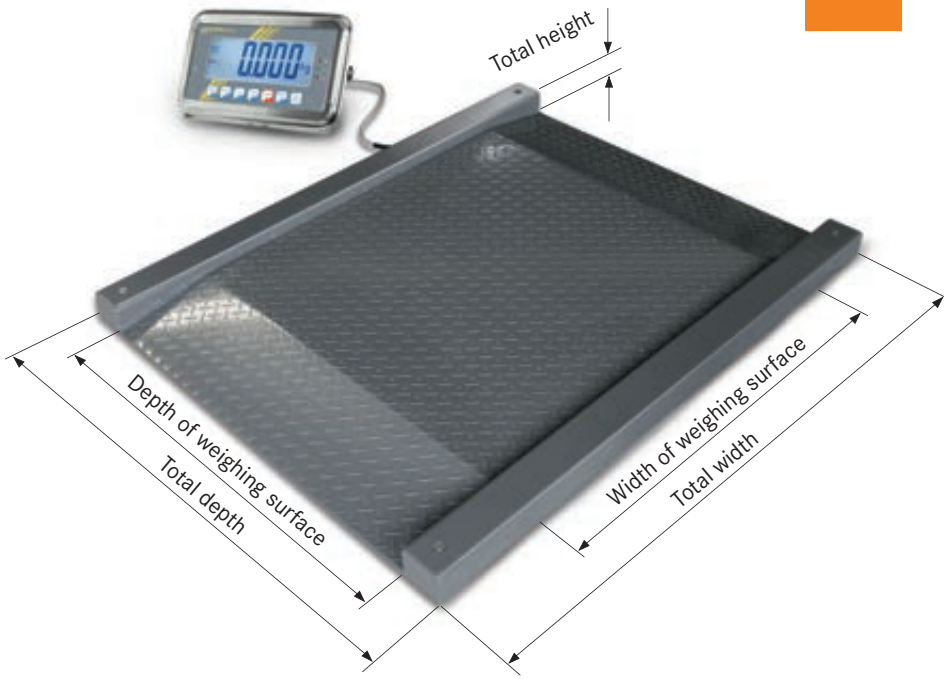

Note: For verified scales the weighing bridge must be fixed to the floor. Optionally, with an access ramp, a footplate pair or a pit frame

Shipment via freight forwarder. Please ask for dimensions, gross weight, shipping costs

Limited tare range with verifiable models (1/6 from [Max])

Drive-through scale (IP67) with stainless steel display device (IP65) and EC type approval [M]

Features

- **Robust drive-through scale** for rapid weighing of e.g. wire cage trolleys, shelf trolleys, container trolleys, storage trolleys, sack trucks, transpallets, mobile containers, containers refuse etc.
- **1 Weighing bridge:** anti-slip corrugated steel plate, lacquered, protection against dust and water splashes (IP67), 4 silicone-coated stainless load cells. Also available as component without the display device, KERN KFD-V30, see page 151
- **2 Display device:** KERN KFN-TM, details see page 148
- **Benchtop stand incl. wall mount** for display device as standard
- **Totalising** of weights and piece counts

Technical data

- Large backlit LCD display, digit height 52 mm
- Overall dimensions WxDxH
A 1600x1200x80 mm, **B** 1800x1400x78 mm

- Overall dimensions, without access ramps (Drive-through width and depth) WxD
A 1000x1000 mm
B 1200x1200 mm
- Dimensions of display device WxDxH 266x175x96 mm
- Cable length of display device approx. 5 m
- Permissible ambient temperature -10 °C / 40 °C

Accessories

- **Protective working cover** over the display device standard. Can be re-ordered, KERN KFB-A02S05, **€ 35,-**
- **3 Stand** to elevate display device, stainless steel, height of stand 750-1000 mm, height-adjustable, must be ordered at purchase, KERN YKP-01, **€ 360,-**
- **Rechargeable battery pack internal**, operating time up to 35 h without backlight, charging time approx. 12 h, KERN GAB-A04, **€ 40,-**

- **Pair of base plates** to fix the weighing bridge to the floor, KERN BFS-A06, **€ 60,-**
- **Data interface RS-232**, interface cable included, approx. 1,5 m, must be ordered at purchase, KERN KFN-A01, **€ 95,-**
- **Y-cable** for parallel connection of two terminal devices to the RS-232 interface on the scale, e.g. signal lamp and printer, KERN CFS-A04, **€ 35,-**
- **4 Signal lamp** for visual support of weighing with tolerance range. For details see page 181, KERN CFS-A03, **€ 250,-**
- **Large display with superior display size**, digit height 76 mm, WxDxH 541x55x180 mm, only in combination with data interface KERN KFN-A01, for details see page 181, KERN YKD-A02, **€ 215,-**
- **Cable with special length 15 m**, between display device and platform, for verified models, this must be ordered at the time of purchase, KERN BFB-A03, **€ 160,-**
- **Suitable printers** and further, extensive accessories from page 177

STANDARD



OPTION



FACTORY



Model	Weighing range [Max] kg	Readout = Verification value [d] = [e] kg	Minimum load [Min] kg	Net weight approx. kg	Weighing plate	Price excl. of VAT ex works €	Options			
							Verification		DAkKS Calibr. Certificate	
							M KERN	€	DKD KERN	€
NBB 600K-1M	600	0,2	4	134	A	1670,-	965-230	132,-	963-130	165,-
NBB 600K-1LM	600	0,2	4	156	B	1770,-	965-230	132,-	963-130	165,-
NBB 1T-1M	1500	0,5	10	140	A	1660,-	965-230	132,-	963-130	165,-
NBB 1T-1LM	1500	0,5	10	150	B	1860,-	965-230	132,-	963-130	165,-

Drive-through scale KERN NFN



Note: For verified scales the weighing bridge must be fixed to the floor with a base plate pair

Shipment via freight forwarder. Please ask for dimensions, gross weight, shipping costs

Stainless steel drive-through scale with IP68 weighing bridge, IP65 display device and EC type approval [M]

Features

- **Robust drive-through scale** made of stainless steel for rapid weighing of e.g., shelf trolleys, container trolleys, storage trolleys, transport cases, transpallets, mobile containers etc.
- **Low platform height** and integrated access ramps on both sides facilitate access.
- **Weighing bridge:** made entirely of stainless steel, extremely resistant to bending due to material thickness, protection against dust and water splashes IP68, 4 welded stainless load cells. Also available as component without the display device, KERN KFD-V40, see page 153
- Ideal for the pharmaceutical and chemical industries
- Your support in a **HACCP**-compliant quality system
- **Display device** KERN KFN-TM, stainless steel, details see page 148
- **Totalising** of weights and piece counts

Technical data

- Large backlit LCD display, digit height 52 mm
- Overall dimensions WxDxH 1600x1200x78 mm
- Overall dimensions, without access ramps (Drive-through width and depth) WxD 1000x1000 mm
- Dimensions of display device WxDxH 266x165x96 mm
- Cable length of display device approx. 5 m
- Net weight approx. 131 kg
- Permissible ambient temperature -10 °C / 40 °C

Accessories

- **Stand** to elevate display device, stainless steel, height-adjustable, height of stand 750-1000 mm, KERN BFN-A04, € 280,-

- **Rechargeable battery pack internal**, operating time up to 35 h without backlight, charging time approx. 12 h, must be ordered at purchase, KERN GAB-A04, € 40,-
- **Pair of base plates** to fix the weighing bridge to the floor, KERN BFN-A03, € 70,-
- **Data interface RS-232**, interface cable included, approx. 1.5 m, must be ordered at purchase, KERN KFN-A01, € 95,-
- **Large display with superior display size**, only in combination with data interface KERN KFN-A01, digit height 76 mm. WxDxH 541x55x180 mm, for details see page 181, KERN YKD-A02, € 215,-
- **Cable with special length 15 m**, between display device and platform, for verified models, this must be ordered at the time of purchase, KERN BFB-A03, € 160,-
- **Suitable printers** and further, extensive accessories from page 177

STANDARD



OPTION



FACTORY



Model	Weighing range	Readout = Verification value	Minimum load	Price excl. of VAT ex works €	Options			
					Verification		DAkkS Calibr. Certificate	
					M KERN	€	DKD KERN	€
NFN 600K-1M	600	0,2	4	2880,-	965-230	132,-	963-130	165,-
NFN 1.5T-4M	1500	0,5	10	2880,-	965-230	132,-	963-130	165,-

Note: For applications that require verification, please order verification at the same time, initial verification at a later date is not possible. Verification at the factory, we need to know the full address of the location of use.



“ **W**hether it's in the office, in production or dispatch, KERN platform scales will prove their worth in all areas of an industrial environment. Designed to be durable and with highly-accurate weighing results they will become an indispensable assistant in the workplace. ”

Jürgen Boschanski, KERN Logistics

Axle load scales

Over the legal limit!

Axle load or wheel load scales are an ideal weighing solution for mobile weighing of trucks, trailers, small aircrafts etc. on a non-verified basis.

Mobile axle load scales are often used to give indicative measurements, in particular on building sites, during harvest time in the agricultural industry or in the field of traffic monitoring, in order to establish whether vehicles are overloaded or incorrectly loaded. If such measurements will show inconsistencies, a second measurement can be carried out on a verified vehicle scale.

Compared with fixed vehicle scales, axle load scales are usually more affordable. They not require costly installation and with their compact dimensions and low weight they clearly score highly in terms of mobility.

Using the convenient software in the KERN axle load scales, individual axles can be weighed quickly and easily, one after another. When connected, the various weights at the individual wheels, the weight of the axle or the total weight of the vehicle can be displayed and transferred to the printer.

Thanks to its compact design with a depth of just 50 cm and the equalisation platforms, two axles can be weighed individually, even if they are installed to one another.

Alternatively the innovative design of the weighing pad allows for 2 axles to be measured at the same time and the results to be added when these 2 axles are installed right next to each other. This double construction is also recommended for vehicles or trailers with exceptionally large wheels.

The modular construction of the KERN VHP facilitates enable a wide... wide range of different combination and can therefore be adapted quickly to suit the on-site conditions:



Weighing of trucks, motor homes, trailers etc. for carrying out quick checks of axle weights in any location (Police), to detect and avoid incorrect loading or overloading



Weighing of tractors, trailers, trucks etc. for products and goods control at the point of receipt or dispatch in locations where there is no permanently installed vehicle scale or one is not available for financial reasons



Weighing of airplanes to calculate the loading scheme and determine the centre of gravity, to make sure that the permissible total weight is not exceeded and that the load is correctly distributed



Stephan Ade
Product specialist Axle load scales

Tel. +49 [0] 7433 9933-121
Fax +49 [0] 7433 9933-29121
ade@kern-sohn.com

Quick-Finder Axle load scales

Read-out	Weighing range	Model	Price excl. of VAT ex works	Page	DAYS ready for shipping		
[d]	[Max]	KERN	€			For an explanation on the pictos, see the front flap	
5 kg	6 t	VHP 6T-3	6890,-	142	2	●	●
10 kg	15 t	VHP 15T-2	6890,-	142	2	●	●

● = Standard

○ = Option



Weighing of airplanes

Order example: standard package VHP 15T-2, see table on the right, 4 x ascending ramp VHP-A01, 2 x weighing pad KHP 75000V20LM

11

Modular axle load scale for the mobile monitoring of vehicles up to 15 tones



Asynchronous weighing of individual axles

Order example: standard package VHP 6T-3 or VHP 15T-2, see table on the right



Asynchronous weighing of double axles which are installed next to each other, using compensation pads

Order example: standard package VHP 6T-3 or VHP 15T-2, see table on the right, 4 x ascending ramp VHP-A01, 2 x compensation pad VHP-A03



Simultaneous weighing of double axles, e.g. of a trailer

Order example: standard package VHP 15T-2, see table on the right, 4 x ascending ramp VHP-A01, 2 x weighing pad KHP 75000V20LM

Axle load scale KERN VHP



Features

- **Mobile axle load scale for rapid monitoring of vehicles.** Space-saving and affordable. Ideal for mobile police or customs checks, on landfill sites, gravel works, biogas plants etc.
- **1 Display device with integrated thermal transfer printer and rechargeable battery pack** in stable, lined transport case standard. 4 quick-release connectors to connect up to 4 weighing pads. The weighing results from the individual weighing pads can be issued individually or cumulatively
KERN VHP-T, **€ 1900,-**
- **2 Weighing pad (wheel load plate) extremely resistant to bending because of its high material thickness.** Particularly flat design, only 35 mm. Brackets for access ramps and spacer plates on both sides, and therefore quickly expendable
 - 2 rollers and 2 handles for easy transport of the weighing pad
 - 6 load cells, aluminium, **silicone-coated, IP65**

Technical data

- Backlit LCD display, digit height 10 mm
- Weighing plate dimensions WxDxH 900x500x35 mm
- Dimensions ascending ramp WxD 900x250 mm
- Dimensions display device (case) 355x300x165 mm
- Net weight for each weighing pad approx. 30,2 kg
- Net weight of each access ramp approx. 12 kg
- Net weight display device (case) approx. 9,2 kg
- **Rechargeable battery pack internal,** standard, operating time up to 13 hours with backlight without use of printer, charging time approx. 12 h. Can be re-ordered, KERN HFM-A01, **€ 50,-**
- Cable length of display device approx. 10 m
- Permissible ambient temperature -40 °C / 70 °C
- **Scope of supply:**
 - 2 weighing pads (wheel load plates)
 - 4 access ramps
 - 1 display device in stable transport case

Note: The standard scope of supplies (see technical data) can be expanded with further weighing pads, ramp extensions and balancing platforms (see accessories) and in this way the system can be adapted to cover a wide range of applications. Do you have any questions or special requests? Your KERN product specialist will be happy to help

Accessories

- **3 Weighing pad to expand the weighing system VHP,** steel, lacquered (orange), 2 rollers and 2 handles, dimensions WxDxH 900x500x35 mm, 1 piece, for model VHP 6T-3: [Max] = 3000 kg, [d] = 5 kg, KERN KHP 3000V20LM, **€ 2650,-**
VHP 15T-2: [Max] = 7500 kg, [d] = 10 kg, KERN KHP 7500V20LM, **€ 2650,-**
- **4 Ascending ramp,** extremely resistant rubber compound, dimensions WxDxH 900x250x35 mm, KERN VHP-A01, **€ 220,-**
- **5 Ramp extension,** extremely resistant rubber compound, dimensions WxDxH 900x545x35 mm, KERN VHP-A02, **€ 320,-**
- **6 Compensation pad,** extremely resistant rubber compound, dimensions WxDxH 900x545x35 mm, KERN VHP-A03, **€ 320,-**
- **Thermal receipt rolls** (10 pieces), suitable for the thermal transfer printer integrated in display device, length approx. 18 m, width 57 mm, Ø 51 mm, KERN RFS-A10, **€ 40,-**
- **DAkKS calibration certificate** (for both pads), see table. DAkKS calibration certificate for one pad, see page 213

STANDARD



OPTION



Model	Weighing range [Max] kg	Readout [d] kg	Weighing pad included with delivery [Max] kg	Price per pair excl. of VAT ex works €	Option DAkKS Calibr. Certificate	
					DKD KERN	€
VHP 6T-3	6000	5	2 x 3000	6890,- ↓	963-132A	880,-
VHP 15T-2	15000	10	2 x 7500	6890,- ↓	963-133A	1000,-

↓ Price reduction

For more information, please visit kern-sohn.com/en/VHP · Order hotline +49 [0] 7433 9933-0

Individuality is the key

Do you have special requests, which are not covered by our extensive balance range? Then why not configure your ideal model yourself, it's quick, individual and affordable.

The choice is yours:

- Choose one of the many KERN weighing bridges, pallet scales or drive-through scales and combine these with one of the many KERN display devices
- Combine your weighing bridge with a KERN display device
- Combine your display device with a KERN weighing bridge

Have your ideal scale verified – with KERN

To help you obtain a verified individual scale combination KERN offers you full support, such as for example

- Issuing of → **proof of compatibility**, see page 145
- Support in preparing for verification, EC type approval, installation conditions
- Issuing of → **declaration of conformity** upon the executed → **conformity evaluation** (manufacturer's initial verification)

Of course there is also the complete service available for you and we set up the required scale combination including verification. All further details can be found on the following pages. Your personal customer consultant will be pleased to assist you, too.

→ See the glossary on page 214 – 216

**Stephan Ade**

Product specialist
Display devices/Platforms/
Weighing bridges

Tel. +49 [0] 7433 9933-121
Fax +49 [0] 7433 9933-29121
ade@kern-sohn.com

You will find a wide variety of display devices, platforms, weighing bridges, etc. in KERN's product range and these can be put together to create your ideal scale. You simply choose the components, KERN handles the rest.

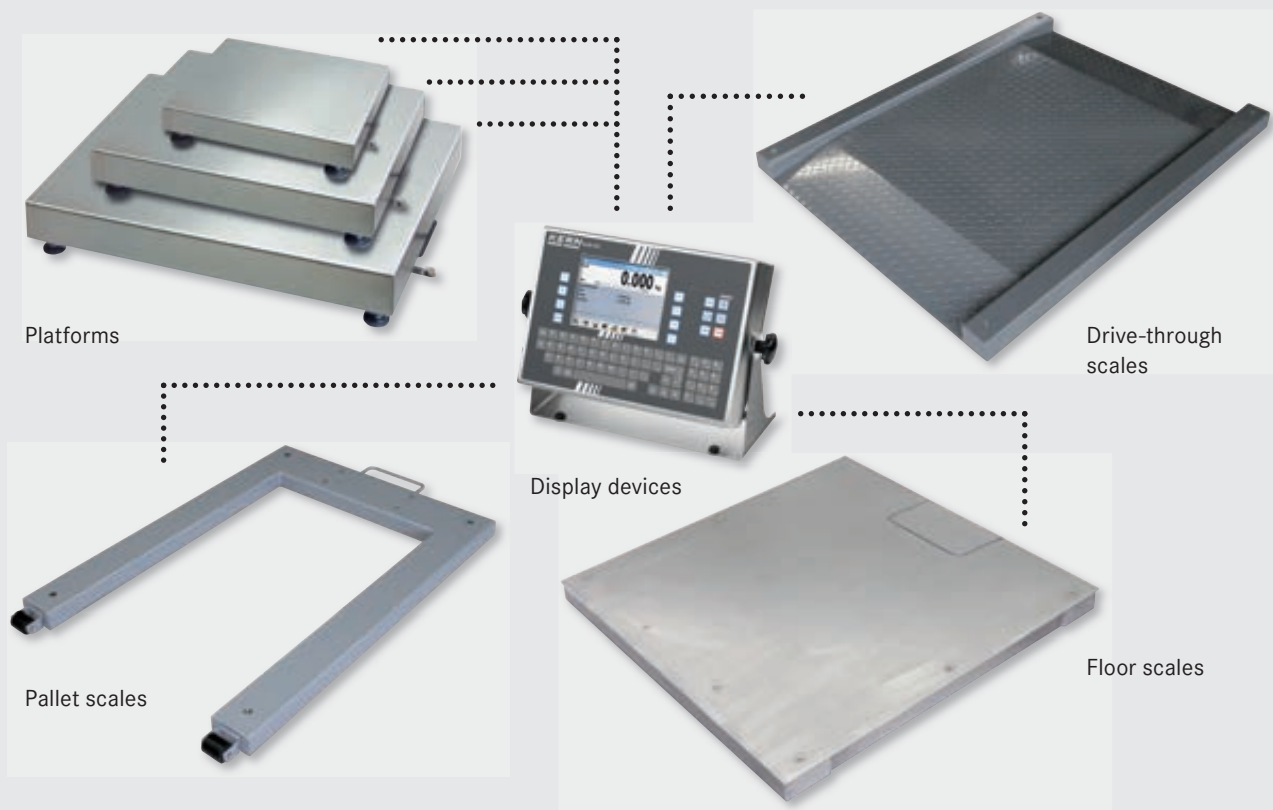

Putting together individual weighing systems which cannot be verified

KERN offers a range of KERN display devices and KERN weighing units, such as platform scales, floor scales, pallet scales and drive-through scales, which you can put together to make your ideal scale. You choose the components, KERN handles the rest.

Assembly

KERN delivers the complete scale which is ready to use.

Prices for assembly can be found in the "Assembly" price table.

On request we can also produce a calibration certificate in accordance with DAkkS/DKD at an additional price, see page 209

Putting together individual weighing systems which can be verified or are verified

In order to provide the complete package, as well as assembling your individual weighing system, KERN will also carry out the manufacturer's initial verification/evaluation for conformity in accordance with EC directives as a commercial scales of verification class III.

In accordance with the verification regulations, when assembling a display device with a weighing unit you must take the following notes into account:

- Only elements which can be verified with build-type approval or OIML test certificate can be combined into a weighing system which can be verified. With KERN these are labelled with "M".
- Platforms with load cells, provided as third-party products which have an OIML test certificate can be included.
- It will not be possible to carry out verification at a later date, e.g. after assembly and delivery of the weighing system. So please order the verification at the same time as you order the weighing system.

The individual KERN steps:

1. Proof of compatibility This is mandatory by law and includes testing by using build-type approvals, whether the connection values of the display device match the connection data of the weighing unit.	Weighing range	Model	Price excl. of VAT, ex works €
	0 up to ... kg	KERN	
	all weighing ranges	965-240	45,-
2. Assembly After testing for suitability, using the proof of compatibility, the weighing system will be wired by KERN. The weighing system will then be adjusted, tested and prepared for verification in accordance with verification regulations.	up to ≤ 50 kg	965-411	70,-
	up to ≤ 350 kg	965-412	100,-
	up to ≤ 1500 kg	965-413	120,-
	up to ≤ 2900 kg	965-414	150,-
	up to ≤ 6000 kg	965-415	250,-
3. Initial verification by the manufacturer KERN is authorised to carry out the initial verification by the manufacturer of scales of verification class III (commercial scales) and is therefore authorised to introduce the weighing system onto the market, after the scale has been sealed with the verification mark.	up to ≤ 5 kg	965-227	55,-
	up to ≤ 50 kg	965-228	55,-
	up to ≤ 350 kg	965-229	93,-
	up to ≤ 1500 kg	965-230	132,-
	up to ≤ 2900 kg	965-231	220,-
	up to ≤ 6000 kg	965-232	320,-
4. Declaration of conformity KERN issues this after manufacturer's initial verification has been carried out successfully and sends it with the verified weighing system at no additional costs.			

Modifications and special services

Description	Model	Price excl. of VAT, ex works €
Cable extensions for platform scales with build-type approval		
up to 4 m extension	965-403	45,-
to 7 m extension	965-404	60,-
to 10 m extension	965-405	75,-
Cable extensions for platform scales without build-type approval		
up to 4 m extension	920-403	45,-
up to 7 m extension	920-404	60,-
up to 10 m extension	920-405	75,-
Setting an individual preload		
Balance with build-type approval	965-401	50,-
Balance without build-type approval	965-406	50,-
Other adjustments in the balance or software changes	965-407	95,-/h Please require
Plug connection (replaces the fixed cable connection between the display device and platform with a plug connection which can be disconnected)		
balances with type approval and verification	not currently possible	
balances with type approval, no verification	965-406	60,-

Order example

KFP 30V20M platform and KEN-TM display device with cable extension (4 m) and setting an individual preload.

	Model	Price excl. of VAT, ex works €
	KERN	
KERN platform	KFP 30V20M	205,-
KERN display device	KFN-TM	290,-
Proof of compatibility	965-240	45,-
Cable extension	965-403	45,-
Setting the preload	965-401	50,-
Assembly	965-411	50,-
Verification at the factory KERN	965-228	55,-
Complete scale (verified)		740,-

Comment:

Please ask for delivery times, dimensions, gross weight and shipping costs. 3 year warranty. Where applications require verification, please order the verification at the same time as you order the scale. It is not possible to perform an initial verification after purchase. It is not possible to return, exchange or receive reimbursement for custom products, as described above, for example. Prices cannot be discounted.

Display devices KERN KFB-TM · KFS-TM · KXG-TM



1 KERN KFB-TM

Display device with large digits – easy to read

2 KERN KFS-TM

Professional indicator with 3 displays, and with EC type approval

3 KERN KXG-TM

IP68 display device with integrated power supply

STANDARD



STANDARD



OPTION

FACTORY

STANDARD

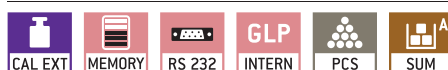

STANDARD



OPTION

FACTORY



STANDARD



STANDARD

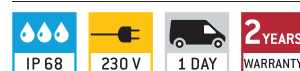

OPTION

FACTORY



Features	Model KERN 1 KERN KFB-TM	Model KERN 2 KERN KFS-TM	Model KERN 3 KERN KXG-TM
Display (segments)	5 + ½ digits	6 digits	6 digits
EC type approval	yes	yes	yes
Resolution verifiable	6.000 e	3.000 e	10.000 e
Resolution non verifiable	30.000 d	60.000 d	30.000 d
Weighing ranges	≤ 2	≤ 2	≤ 2
Weighing units	kg	kg	kg
Read-out	1, 2, 5, 10, n	1, 2, 5, ... 10, n	1, 2, 5, 10, 20, 50
Piece counting with reference	10, 20, 50, 100, 200	n	10, 20, 50, 100, 200
Display, digit height	Backlit LCD display, 52 mm	Backlit LCD display, 13/16,5 mm	Backlit LCD display, 55 mm
Additional functions	Totalising, HOLD function	99 item memories, totalising, printing of date and time	PRE-TARE function, totalising, HOLD function, peak hold, zero-point memorisation
Strain gauge load cells	87 – 1600 Ω	87 – 1600 Ω	87 – 1600 Ω
Linearisation	2 points	4 points	2 – 7 points
Input voltage	12 V/500 mA	12 V/500 mA	110 – 230 V AC
Permissible ambient temperature	-10 °C/40 °C (verified)	0 °C/40 °C	-10 °C/40 °C (not verified)
Interface RS-232	yes	yes	KXS-A04, € 40,-
Interface RS-485	-	-	KXS-A01, € 85,-
Interface Bluetooth	-	-	KXS-A02, € 110,- (Scale → PC)
Foot switch	-	-	KXS-A03, € 70,-
Stand	BFS-A07, see page 125, € 120,-	BFS-A07, see page 125, € 120,-	YKP-A02, € 210,-
Benchtop stand for display device/wall mount	yes/yes	yes/yes	yes/yes
Protective working cover	KFB-A02S05, see page 112, € 35,-	KFB-A02S05, see page 93, € 35,-	-
Rechargeable battery pack	KFB-A01, see page 112, € 35,-	KFS-A01, see page 93, € 35,-	GAB-A04, € 40,-
Operating/charging time	approx. 35 h/12 h	approx. 40 h/12 h	80 h/12 h
Dimensions Housing WxDxH	250x160x58 mm	260x150x65 mm	323x170x80 mm
Net weight	1,5 kg	1,5 kg	2 kg
Price excl. of VAT, ex works €	200,-	210,-	210,-

Display devices KERN KFE-TM · KFN-TM · KXS-TM



4 KERN KFE-TM

Stainless steel display device with IP65 protection

5 KERN KFN-TM

Stainless steel display device with IP65 protection and superior display size

6 KERN KXS-TM

Stainless steel display device with IP68 protection and integrated power supply

STANDARD



STANDARD



FACTORY



STANDARD



STANDARD



OPTION

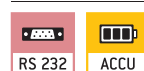

FACTORY



STANDARD



STANDARD

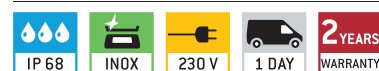

OPTION

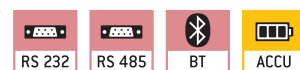

FACTORY



Features	Model KERN 4 KERN KFE-TM	Model KERN 5 KERN KFN-TM	Model KERN 6 KERN KXS-TM
Display (segments)	6 digits	5 + ½ digits	6 digits
EC type approval	yes	yes	yes
Resolution verifiable	6.000 e	6.000 e	10.000 e
Resolution non verifiable	30.000 d	30.000 d	30.000 d
Weighing ranges	≤ 2	≤ 2	≤ 2
Weighing units	kg	kg	kg
Read-out	1, 2, 5, 10, n	1, 2, 5, 10, n	1, 2, 5, 10, 20, 50
Piece counting with reference	-	10, 20, 50, 100, 200	10, 20, 50, 100, 200
Display, digit height	Backlit LCD display, 22 mm	Backlit LCD display, 52 mm	Backlit LCD display, 55 mm
Additional functions	-	Totalising, HOLD function	PRE-TARE function, totalising, HOLD function, peak hold, zero-point memorisation
Strain gauge load cells	87 - 1200 Ω	87 - 1600 Ω	87 - 1600 Ω
Linearisation	2 points	2 points	2 - 7 points
Input voltage	12 V/500 mA	12 V/500 mA	220 - 240 V AC
Permissible ambient temperature	-10 °C/40 °C (verified)	-10 °C/40 °C (verified)	-10 °C/40 °C (verified)
Interface RS-232	-	KFN-A01E, see page 81, € 95,-	KXS-A04E, € 40,-
Interface RS-485	-	-	KXS-A01E, € 85,-
Interface Bluetooth	-	-	KXS-A02E, € 110,- (Scale → PC)
Foot switch	-	-	KXS-A03E, € 70,-
Stand	-	BFS-A07, see page 127, € 120,-	YKP-01, € 360,-
Benchtop stand for display device/wall mount	yes/yes	yes/yes	yes/yes
Protective working cover	-	-	-
Rechargeable battery pack	standard	GAB-A04, € 40,-	GAB-A04, € 40,-
Operating/charging time	approx. 45 h/12 h	approx. 50 h/12 h	80 h/12 h
Dimensions Housing WxDxH	195x118x83 mm	266x165x96 mm	232x170x80 mm
Net weight	1 kg	2 kg	2,5 kg
Price excl. of VAT, ex works €	240,-	290,-	300,-



7 KERN KET-TAM

Modern touchscreen display

STANDARD



STANDARD



OPTION



FACTORY



8 KERN KEN-TM

Modern stainless steel touchscreen display with alphanumeric keyboard

STANDARD



STANDARD



STANDARD



OPTION



FACTORY



Features	
Display (segments)	7
EC type approval	yes
Resolution verifiable	6.000 e
Resolution non verifiable	100.000 d
Weighing ranges	3
Weighing units	kg, g, ct, lb, N, oz
Read-out	1, 2, 5, 10
Piece counting with reference	5, 10, 25, 50, 100, n
Display, digit height	21/19 mm
Additional functions	8 GB internal memory, 64 MB RAM, Dual-Core processor, alibi memory, password protection, user profiles, up to 4 platforms can be connected
Strain gauge load cells	80 – 1200 Ω
Linearisation	6 points
Input voltage	10 – 15 V DC 1,4 A
Permissible ambient temperature	-10 °C/40 °C (verified)
Interface RS-232	yes
Interface USB	yes
Analogue module	-
Relay output (4 relays)	-
Interface DIGITAL I/O	yes
DIGITAL I/O cable	-
Profibus module	-
Interface DUAL	-
Interface LAN	yes
Interface Bluetooth	-
Signal lamp	Scope of delivery: signal lamp CFS-A03, adapter cable KET-A11, KERN KET-A10, € 270,-
Stand	-
Benchtop stand for display device/wall mount	Wall mount: KERN KET-A02, € 190,-
Protective working cover	-
Rechargeable battery pack	-
Operating/charging time	-
Further accessories	see page 184 ff.
Dimensions Housing WxDxH	215x156x71 mm
Net weight	0,65 kg
Price excl. of VAT, ex works €	1600,-

Model KERN	
7 KERN KET-TAM	
7 digits	
yes	
6.000 e	
100.000 d	
3	
kg, g, ct, lb, N, oz	
1, 2, 5, 10	
5, 10, 25, 50, 100, n	
21/19 mm	
8 GB internal memory, 64 MB RAM, Dual-Core processor, alibi memory, password protection, user profiles, up to 4 platforms can be connected	
80 – 1200 Ω	
6 points	
10 – 15 V DC 1,4 A	
-10 °C/40 °C (verified)	
yes	
yes	
-	
-	
yes	
-	
-	
yes	
-	
yes	
-	
Scope of delivery: signal lamp CFS-A03, adapter cable KET-A11, KERN KET-A10, € 270,-	
-	
Wall mount: KERN KET-A02, € 190,-	
-	
-	
-	
see page 184 ff.	
215x156x71 mm	
0,65 kg	
1600,-	

Model KERN	
8 KERN KEN-TM	
7 digits	
yes	
6.000 e	
100.000 d	
3	
kg, g, ct, lb, N, oz	
1, 2, 5, 10	
5, 10, 25, 50, 100, n	
21/19 mm	
8 GB internal memory, 64 MB RAM, Dual-Core processor, alibi memory, password protection, user profiles, up to 4 platforms can be connected	
80 – 1200 Ω	
6 points	
100 – 240 V AC 65 mA	
-10 °C/40 °C (verified)	
yes; interface cable compulsory, KEN-A01, € 80,-	
yes; interface cable compulsory, KEN-A02, € 140,-	
KERN KEN-A06, € 350,-	
KERN KEN-A07, € 180,-	
8 in/8 out, KERN KEN-A08, € 600,-	
KEN-A04, € 140,-	
KERN KEN-A09, € 250,-	
yes	
yes; LAN cable compulsory, KEN-A03, € 140,-	
-	
Scope of delivery: signal lamp CFS-A03, adapter cable KET-A11, KERN KET-A10, € 270,-	
-	
Benchtop stand incl.	
-	
-	
-	
see page 184 ff.	
282x200x76 mm	
4,5 kg	
2300,-	

Platforms KERN KFP · KXP

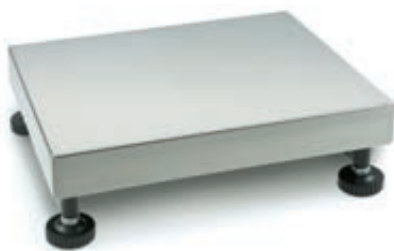

1 KERN KFP V20 IP65

Platform



- **1 Stainless steel-weighing plate**
A Painted steel base
- **1 load cell, aluminium, silicone-coated, IP65, OIML-R60-approved, class III, 3000 e**
- **Level indicator and levelling feet** for precise levelling of the scale

2 KERN KXP V20 IP65

Platform



- **2 Stainless steel-weighing plate, B Painted steel base**, is extremely rigid, wing design
- **1 load cell, aluminium, silicone-coated, IP65, OIML-R60-approved, class III, 3000 e**
- **Level indicator and levelling feet** for precise levelling of the scale



Model	Weighing range [Max] kg	Readout [d] g	Verific. value [e] g	Min. load [Min] g	Add. preload kg	Cable length approx. m	Net weight approx. kg	Weighing plate mm	Price excl. VAT, ex works €
1 Platform KFP V20 IP65									
KFP 6V20M	6	2	2	40	1	2,5	3,7	230x230x110	160,-
KFP 6V20LM	6	2	2	40	2	2,5	4,6	300x240x110	180,-
KFP 15V20M	15	5	5	100	2	2,5	4,6	300x240x110	175,-
KFP 15V20LM	15	5	5	100	5	2,5	9,7	400x300x128	205,-
KFP 30V20M	30	10	10	200	5	2,5	9,7	400x300x128	205,-
KFP 60V20M	60	20	20	400	5	2,5	9,7	400x300x128	210,-
KFP 60V20LM	60	20	20	400	7	2,5	12,5	500x400x137	260,-
KFP 150V20M	150	50	50	1000	7	2,5	12,5	500x400x137	260,-
KFP 150V20LM	150	50	50	1000	11	2,5	20,75	650x500x142	460,-
KFP 300V20M	300	100	100	2000	10	2,5	20,75	650x500x142	455,-
KFP 600V20AM	600	200	200	4000	20	3	50	800x600x150	730,-
2 Platform KXP V20 IP65									
KXP 6V20LM	6	2	2	40	2	3	3,2	300x240x90	220,-
KXP 15V20M	15	5	5	100	2	3	3,2	300x240x96	220,-
KXP 30V20M	30	10	10	200	10	3	7,5	400x300x89	310,-
KXP 30V20LM	30	10	10	200	5	3	17,5	500x400x132	450,-
KXP 60V20M	60	20	20	400	10	3	7,5	400x300x90	310,-
KXP 60V20LM	60	20	20	400	10	3	17,5	500x400x123	460,-
KXP 150V20M	150	50	50	1000	10	3	17,5	500x400x123	450,-
KXP 150V20LM	150	50	50	1000	10	3	32,4	650x500x133,5	480,-
KXP 300V20M	300	100	100	1000	20	3	32,5	650x500x133,5	480,-

Weighing bridges KERN KFP · KFD

NEW

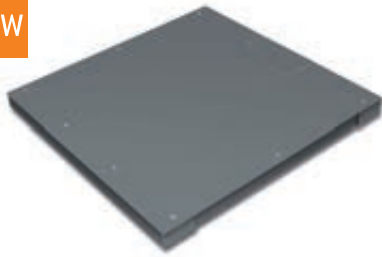

3 KERN KFP V20 IP67

Weighing bridge



- **Weighing plate screwed on from the top (models with [Max] ≤ 1500 kg)**, so it is easy to remove, hygienic and easy to clean
- **Lacquered steel weighing bridge**, models with weighing range [Max] ≥ 3000 kg corrugated steel plate.. Extremely resistant to bending due to material thickness
- **4 Load cells, steel, silicone-coated, IP67, OIML-R60-approval for verification**, class III, 3000 e
- Can be built in using pit frames (optional)
- **Level indicator and levelling feet** for precise levelling of the scale
- **Easy access to the junction box** from the top
- **Comfortable levelling of the weighing bridge** from the top
- Accessories page 125 (KERN BFB)

4 KERN KFD V20

Weighing bridge



- **Weighing bridge made of non-slip corrugated steel plate**, lacquered, two access ramps integrated, extremely resistant to bending
- Extremely flat construction to facilitate access: access height only 45 mm
- **4 Load cells, alloy steel, silicone-coated, IP67, OIML-R60-approved** class III, 3000 e
- Accessories page 137 (KERN NFB)



Model	Weighing range [Max] kg	Readout [d] g	Verific. value [e] g	Min. load [Min] g	Add. preload kg	Cable length approx. m	Net weight approx. kg	Weighing plate mm	Price excl. VAT, ex works €
3 Weighing bridge KFP V20 IP67									
KFP 600V20SNM	600	200	200	4000	120	5	105	1000x1000x85	950,-
KFP 600V20NM	600	200	200	4000	120	5	175	1500x1250x85	1410,-
KFP 1500V20SNM	1500	500	500	10000	300	5	105	1000x1000x85	950,-
KFP 1500V20NM	1500	500	500	10000	300	5	175	1500x1250x85	1190,-
KFP 3000V20LM	3000	1000	1000	20000	500	5	175	1500x1250x80	1190,-
KFP 6000V20M	6000	2000	2000	40000	1000	5	208	1500x1500x130	1930,-
4 Drive-through scale KFD V20									
KFD 600V20M	600	200	200	4000	120	5	130	1600x1200x78	1270,-
KFD 600V20LM	600	200	200	4000	120	5	175	1800x1400x78	1450,-
KFD 1500V20M	1500	500	500	10000	300	5	130	1600x1200x78	1270,-
KFD 1500V20LM	1500	500	500	10000	300	5	175	1800x1400x78	1460,-

Price reduction

For more information, please visit www.kern-sohn.com/en · Order hotline +49 [0] 7433 9933-0

Display devices/Platforms/Weighing bridges

Weighing beams/U-Weighing bridges KERN KFA · KFU



5 KERN KFA V20

Weighing beams

STANDARD

- IP 67
- 2 DAYS
- 3 YEARS WARRANTY

- Weighing beams and painted steel base
- 4 load cells, alloy steel, silicone-coated, IP67
- Levelling feet for precise levelling of the weighing beams
-  Image below: Version up to 6 t available. Each weighing beam has a roller and handle for easy transport of the scale (KERN KFA-L)
- Accessories page 133 (KERN UFA)

6 KERN KFU V20

U-Weighing bridge

STANDARD

- IP 67
- 2 DAYS
- 3 YEARS WARRANTY

FACTORY

- M

- Load range: painted steel (V20), height 90 mm
- 4 load cells, alloy steel, silicone-coated, IP67, OIML-R60-approval for verification, class III, 3000 e
- 2 rollers and handle for easy transport of the scale
- Accessories page 134 (KERN UFB)

7 KERN KFU V30

U-Weighing bridge

STANDARD

- IP 67
- INOX
- 2 DAYS
- 3 YEARS WARRANTY



FACTORY

- M

- Load range: stainless steel (V30), height 90 mm
- 4 load cells, alloy steel, silicone-coated, IP67, OIML-R60-approval for verification, class III, 3000 e
- 2 rollers and handle for easy transport of the scale
- Accessories page 136 (KERN UFN)



12

Model	Weighing range [Max] kg	Readout [d] g	Verific. value [e] g	Min. load [Min] g	Add. preload kg	Cable length approx. m	Net weight approx. kg	Weighing plate mm	Price excl. VAT, ex works €
5 Weighing beams KFA V20									
KFA 1500V20	1500	500	-	-	300	5	35	2x 1200x120x100	820,-
KFA 3000V20	3000	1000	-	-	500	5	35	2x 1200x120x100	820,-
KFA 3000V20L	3000	1000	-	-	500	5	64	2x 2000x120x100	1000,-
KFA 6000V20	6000	2000	-	-	500	5	82	2x 1200x163x80	1140,-
KFA 6000V20L	6000	2000	-	-	500	5	125	2x 2000x160x85	1440,-
6 U-Weighing bridge KFU V20									
KFU 600V20M	600	200	200	4000	120	5	41	842x1300x90	690,- 
KFU 1500V20M	1500	500	500	10000	300	5	41	842x1300x90	690,- 
7 Stainless steel U-Weighing bridge KFU V30									
KFU 600V30M	600	200	200	4000	120	5	42	842x1300x90	1700,-
KFU 1500V30M	1500	500	500	10000	300	5	42	842x1300x90	1700,-

 Price reduction

Platforms/Weighing bridges KERN KFP · KFD



8 KERN KFP V30

Platform



- **8** Stainless steel-weighing plate,
E Stainless steel substructure
- **1 load cell, Stainless steel, silicone-coated, IP67, OIML-approved, class III, 3000 e**
- **Level indicator and levelling feet** for precise levelling of the scale

9 KERN KFP V40

Weighing bridge



- **Weighing bridge entirely made of stainless steel**, extremely resistant to bending because of its high material thickness
- **E** Weighing plate fixed with stainless steel screws, for easier access to the loadcells from above
- **4 load cells, stainless steel, encapsulated, IP68, OIML-R60-approved, class III, 3000 e**
- Can be built in using pit frames (optional)
- **Level indicator and levelling feet** for precise levelling of the scale
- **Comfortable levelling of the weighing bridge** from the top
- Accessories page 131 (KERN BFN)

10 KERN KFD V40

Weighing bridge



- **Weighing bridge made from stainless steel**, two integrated access ramps, extremely resistant to bending
- Extremely flat construction to facilitate access: access height only 45 mm
- **4 load cells, stainless steel, encapsulated IP68, OIML-R60-approval for verification, class III, 3000 e**
- **Level indicator and levelling feet** for precise levelling of the scale
- Accessories page 139 (KERN NFN)



Model	Weighing range [Max] kg	Readout [d] g	Verific. value [e] g	Min. load [Min] g	Add. preload kg	Cable length approx. m	Net weight approx. kg	Weighing plate mm	Price excl. VAT, ex works €
8 Stainless steel platform KFP V30									
KFP 15V30M	15	5	5	100	2	2,5	4,6	300x240x96	470,-
KFP 30V30M	30	10	10	200	5	2,5	9,7	400x300x128	545,-
KFP 60V30M	60	20	20	400	5	2,5	9,7	400x300x128	530,-
KFP 60V30LM	60	20	20	400	7	2,5	14,3	500x400x137	630,-
KFP 60V30XLM	60	20	20	400	10	2,5	20,75	650x500x142	960,-
KFP 150V30SM	150	50	50	1000	5	2,5	9,7	400x300x128	520,-
KFP 150V30M	150	50	50	1000	7	2,5	14,3	500x400x137	630,-
KFP 150V30LM	150	50	50	1000	10	2,5	20,75	650x500x142	950,-
KFP 300V30M	300	100	100	2000	10	2,5	20,75	650x500x142	940,-
9 Stainless steel weighing bridge KFP V40									
KFP 600V40SM	600	200	200	4000	80	5	85	1000x1000x80	2610,-
KFP 1500V40SM	1500	500	500	10000	160	5	85	1000x1000x80	3330,-
KFP 1500V40M	1500	500	500	10000	160	5	175	1500x1250x80	3330,-
KFP 3000V40M	3000	1000	1000	20000	240	5	175	1500x1250x80	3350,-
10 Stainless steel weighing bridge KFD V40									
KFD 600V40M	600	200	200	4000	120	5	130	1600x1200x45	2880,-
KFD 1500V40M	1500	500	500	10000	300	5	130	1600x1200x45	2880,-

Weighing and transporting – just one operation

Speed up your warehouse and dispatch processes with the KERN pallet truck scales.

Get the exact weight of a load and at the same time, transport it to a specific location, all in one operation. This reduces commissioning times and avoids queues in front of fixed floor scales.

These mobile weighing solutions are space-saving and deliver reliable weighing results. Differences between given and actual weights can be determined quickly e.g. in the goods-in and out department. This uncovers inaccurate quantities, saves time and money and therefore ensures a very short amortisation period of the scales original cost.

KERN offers a carefully coordinated range from the affordable entry level model to the comfort model with printer and removable battery pack.

KERN pallet truck scales are of robust industrial quality, with high-level protection against dust and water splashes, with high-contrast, easy-to-read displays as well as solid wheels and load rollers – all this helps to give you practical support in your work – day after day.

Of course, all KERN pallet truck scales can also be calibrated and delivered with a DAkkS calibration certificate (optional). This ensures the high level of accuracy of your pallet truck scale.

Quick-Finder Pallet truck scales

Read-out [d]	Weighing range [Max]	Model KERN	Price excl. of VAT ex works €	Page	DAYS ready for shipping	CAL EXT	IP	BATT	ACCU
1 kg	2 t	VHB 2T1	1350,-	157	2	●	●	●	
1 kg	2 t	VFB 2T-3	1430,-	156	2	●	●		●
1 kg	2 t	VFS 2T1	1780,-	158	2	●	●		●
5 kg	2 t	VHE 2T5A	830,-	155	2	●	●	●	

● = Standard

○ = Option



Your product specialist's recommendation:

- The power pack in the dispatch department and the warehouse**
- The display device is well-protected by a metal frame**
- Optimised load rollers so that you can get over rough ground more easily and greater manoeuvrability**



Katharina Queitsch
Product specialist Pallet truck scales

Tel. +49 [0] 7433 9933-218
Fax +49 [0] 7433 9933-29218
katharina.queitsch@kern-sohn.com

KERN VHE

only €
830,-

▶ page 155

Pallet truck scale KERN VHE-A

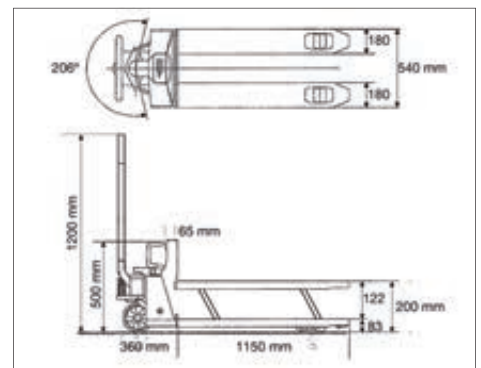

Entry-level model into mobile weighing

Features

- **Highly versatile for general checkweighing**, e.g.: plausibility check at goods receiving, determining shipping weights, avoiding overloads, safety checks
- **Very manoeuvrable** thanks to its compact construction and low weight
- **Particularly robust** with its components having been relocated from the load fork into the protected housing area. It is therefore also ideal for heavy applications in the production area and on board lorries
- **Display device:** Protection against dust and water splashes IP65
- **Low height of the loading forks** easy uplifting to work with low pallets
- **Pivot range 206°**
- **Castors:** Solid rubber on aluminium rims
- **Load rollers:** Polyurethane

Operation:

- 1 Switch on and then pump up the load fork to the reference height
 - 2 Tare off
 - 3 Release the load fork and load the goods to be weighed
 - 4 Weighing: Pump the load fork with the goods to be weighed up to the reference height, read off the weight
- **Ready for use:** Batteries included 2 x 1.5 V AA. AUTO-OFF function to preserve the batteries. Operating time approx. 1 year/approx. 3000 weighings. Charge status indicator on display

Technical data

- Large LCD display, digit height 18 mm

! Shipment via freight forwarder. Please ask for dimensions, gross weight, shipping costs

STANDARD



OPTION



Model	Weighing range	Readout	Net weight approx.	Permissible ambient temperature	Price excl. of VAT ex works €	Option	
						DAKKS Calibr. Certificate	
KERN VHE 2T5A	[Max] kg 2000	[d] kg 5	kg 65	°C -10 °C / 40 °C	€ 830,-	DKD KERN 963-131	€ 220,-

Pallet truck scale KERN VFB



Pallet truck scale with totalising function for weights and integrated rechargeable battery pack

Features

- **PRE-TARE function** for manual deduction of a known container weight (e.g. pallet, mesh crate etc.)
- **Load fork:** Protection against dust and water splashes IP67, temporary use in wet areas possible
- **Pivot range 180°**
- **Castors:** Solid rubber on aluminium rims
- **Load rollers:** Tandem tyres to overcome thresholds and obstacles more easily. Material: Polyurethane
- **Check the weighing range** which is in use at the press of a button (net/gross weight)
- **Totalising** of weights
- **Rechargeable battery pack internal,** standard, operating time up to 40 h without backlight, charging time approx. 12 h. Can be re-ordered KERN VFB-A02, € 40,-

Technical data

- **Backlit LCD display,** digit height 22 mm

Accessories

- **Protective working cover** over the display device, can be retrofitted, KERN VFB-A01S05, € 25,-

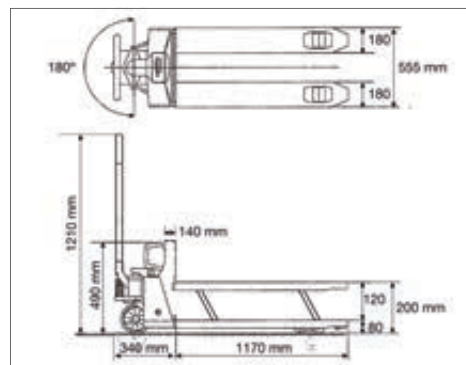

Note: As standard, the unit is dispatched without the shaft and display fitted. The shaft and display can be fitted at our factory for an additional cost, delivery + 2 working days, KERN VFS-M01, € 150,- Please state when ordering

Shipment via freight forwarder. Please ask for dimensions, gross weight, shipping costs

STANDARD



OPTION



only with VFS-M01

Model	Weighing range	Readout	Net weight approx.	Permissible ambient temperature	Price excl. of VAT ex works	Option	
						DAkKS Calibr. Certificate	
KERN	[Max] kg	[d] kg	kg	°C	€	DKD KERN	€
VFB 2T-3	2000	1	126	-10 °C / 40 °C	1430,-	963-131	220,-

Pallet truck scale KERN VHB



Pallet truck scale with complete protection against dust and water splashes IP65/67 and a memory for a container weight

Features

- **PRE-TARE function** for manual subtraction of a known container weight, value can be saved
- **1 Display device:** Protection against dust and water splashes IP65
- **2 Load fork:** Protection against dust and water splashes IP67, temporary use in wet areas possible
- **Pivot range 206°**
- **Castors:** Solid rubber on aluminium rims
- **3 Load rollers:** Tandem tyres to overcome thresholds and obstacles more easily. Material: Polyurethane
- **Totalising** of weights
- **Ready for use:** Batteries included (4 x 1.5 V AA). AUTO-OFF function to preserve the batteries. Operating time approx. 80 h / 1700 weighings

Technical data

- Large LCD display, digit height 28 mm

Accessories

- **Castors made of red polyurethane on aluminium rims.** Ideal for light-coloured flooring as they leave less visible abrasive marks. Suitable for the current models of the pallet truck scale ranges KERN VHB, KERN VHS (when retrofitting, please give the serial number of the pallet truck scale available when ordering), KERN VHB-A02, € 120,-

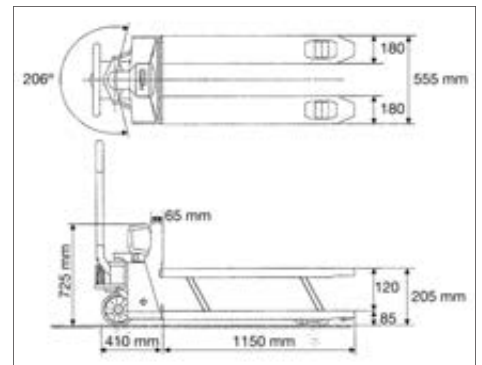

1 Shipment via freight forwarder. Please ask for dimensions, gross weight, shipping costs

13

STANDARD



OPTION



Model	Weighing range	Readout	Net weight approx.	Permissible ambient temperature	Price excl. of VAT ex works	Option	
						DAKKS Calibr. Certificate	
KERN VHB 2T1	[Max] kg 2000	[d] kg 1	kg 120	°C -10 °C / 40 °C	€ 1350,-	DKD KERN 963-131	€ 220,-

Pallet truck scale KERN VFS

PREMIUM



Pallet truck scale with large display, integrated printer, rechargeable battery pack and complete dust and spray protection to IP 65/67

Features

- **PRE-TARE function** for manual deduction of a known container weight (e.g. pallet, mesh crate etc.)
- **1 Display device:** Protection against dust and water splashes IP65
- **2 Load fork:** Protection against dust and water splashes IP67, temporary use in wet areas possible
- **Pivot range 180°**
- **Castors:** Solid rubber on aluminium rims
- **Load rollers:** Tandem tyres to overcome thresholds and obstacles more easily. Material: Polyurethane
- **Rechargeable battery pack internal,** standard, operating time up to 60 h, charging time approx. 12 h. Can be re-ordered, KERN HFM-A01, € 50,-

- **3 Integrated thermal printer,** standard. Printout with date and time. Width of paper 56 mm, 20 characters/line, print-out speed up to 45 mm/sec, temperature range 0 °C / +40 °C

Technical data

- Large backlit LCD display, digit height 52 mm

Accessories

- **Thermal receipt rolls** (10 pieces), width 56 mm, Ø 51 mm, KERN RFS-A10, € 40,-

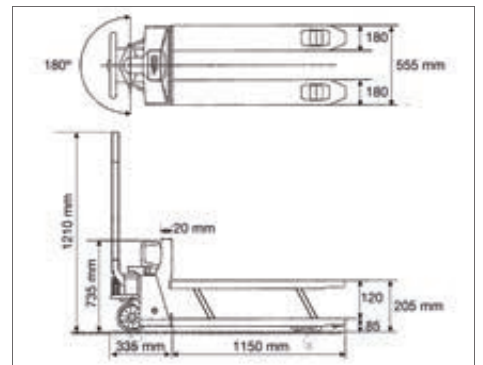

Note: As standard, the unit is dispatched without the shaft and display fitted. The shaft and display can be fitted at our factory for an additional cost, delivery + 2 working days, KERN VFS-M01, € 150,- Please state when ordering

1 Shipment via freight forwarder. Please ask for dimensions, gross weight, shipping costs

STANDARD



1

2

OPTION



only with VFS-M01

Model	Weighing range	Readout	Net weight approx.	Permissible ambient temperature	Price excl. of VAT ex works	Option	
						DAkKS Calibr. Certificate	
KERN	[Max] kg	[d] kg	kg	°C	€	DKD KERN	€
VFS 2T1	2000	1	125	-10 °C / 40 °C	1780,-	963-131	220,-

1 ONLY WHILE STOCKS LAST

Hanging scales/Crane scales

TÜV-tested safety

KERN puts great emphasis on safety. For your safety, all KERN hanging and crane scales are subject to a stringent load test in accordance with EN 13155 and EN 61010-1 industry standards.

New in the KERN crane scale range: Compact crane scales/load receptors/tensile dynamometers – KERN HFA and HFC.

As well as the classic crane scales, we also have electronic tensile dynamometers which are extremely versatile thanks to their stable, compact construction. They can, for example, be fitted into testing machines, used for checking for overload, for bracing and tensile force measurement, etc.

This type of device is ideally suited for use between shackles or with a test bench. This is where the benefit of this construction comes to the fore, as the tensile force can be applied in both directions. These compact crane scales are also particularly suitable when weighing suspended loads where space is tight.

At the core of this construction is a robust load cell. Through the absence of moving parts, these balances are practically maintenance and wear free.



Tip

DAkkS calibration certificates (DKD) for crane scales up to 12 t

Do you use crane scales in ISO-certified processes? Then we can produce the right calibration certificate for your measuring device. Thanks to a modern crane scale test unit, we can calibrate crane scales and force-measuring devices from any manufacturer to a maximum load of up to 12 t or 120 kN. You can find all the important details on pages 209, 213 or directly from one of our calibration specialists, we will be pleased to help you.



Your product specialist's recommendation:

-  **For loads up to 10 tonnes**
-  **High-contrast display for optimum readability from a distance**
-  **TÜV-tested safety**



Lisa Mayer
Product specialist
Hanging scales/Crane scales

Tel. +49 [0] 7433 9933-219
Fax +49 [0] 7433 9933-29219
lisa.mayer@kern-sohn.com



from €
1020,-









► page 166

KERN HFO

HIGH-LIGHT



Quick-Finder Hanging scales/Crane scales

Read-out	Weighing range	Model	Price excl. of VAT ex works €	Page	 DAYS ready for shipping								
[d]	[Max]	KERN				For an explanation on the pictos, see the front flap							
5 g	5 kg	HDB 5K5N	60,-	161	1		●		●			●	
10 g	10 kg	HDB 10K10N	60,-	161	1		●		●			●	
10 g	20 kg	HCB 20K10	105,-	162	1		●		●			●	
20 g	15 kg	CH 15K20	71,-	161	1		●		●			●	
20 g	50 kg	HCB 50K20	115,-	162	1		●		●			●	
50 g	50 kg	CH 50K50	76,-	161	1		●		●			●	
50 g	99 kg	HCB 99K50	100,-	162	1		●		●			●	
50 g	150 kg	HFB 150K50	355,-	165	1		●						●
100 g	50 kg	CH 50K100	66,-	161	1		●		●			●	
100 g	50 kg	HCB 50K100	90,-	162	1		●		●			●	
100 g	50 kg	HCN 50K100IP	130,-	162	1		●		●	●	●	●	
100 g	200 kg	HCB 200K100	110,-	162	1		●		●			●	
100 g	300 kg	HFB 300K100	385,-	165	1		●						●
100 g	1 t	HFM 1T0.1	710,-	166	1		●						●
200 g	100 kg	HCB 100K200	110,-	162	1		●		●			●	
200 g	100 kg	HCN 100K200IP	130,-	162	1		●		●	●	●	●	
200 g	600 kg	HFB 600K200	385,-	165	1		●						●
200 g	600 kg	HFA 600K-1	590,-	163	1		●					○	●
500 g	200 kg	HCB 200K500	99,-	162	1		●		●			●	
500 g	200 kg	HCN 200K500IP	130,-	162	1		●		●	●	●	●	
500 g	1 t	HFA 1T-4	690,-	163	1		●					○	●
500 g	1 t	HFC 1T-4	990,-	164	1		●					○	●
500 g	1 t	HFO 1.5T0.5M	1020,-	166	1	○	●						●
500 g	1,5 t	HTS 1T-4AM	1140,-	167	1	○	●						●
500 g	3 t	HFM 3T0.5	740,-	166	1		●						●
500 g	3 t	HFT 3T0.5	1200,-	168	2*		●	●	●				●
500 g	5 t	HFM 5T0.5	960,-	166	1		●						●
1000 g	0,5 t	HCB 0.5T-3	215,-	162	1		●		●			●	
1000 g	3 t	HFA 3T-3	750,-	163	1		●					○	●
1000 g	3 t	HFC 3T-3	1050,-	164	1		●					○	●
1000 g	3 t	HFO 3T1M	1150,-	166	1	○	●						●
1000 g	3 t	HTS 3T-3AM	1200,-	167	1	○	●						●
1000 g	5 t	HFT 5T1	1440,-	168	2*		●	●	●				●
1000 g	10 t	HFM 10T1	1250,-	166	1		●						●
2000 g	1 t	HCB 1T-3	275,-	162	1		●		●			●	
2000 g	5 t	HFA 5T-3	790,-	163	1		●					○	●
2000 g	5 t	HFC 5T-3	1090,-	164	1		●					○	●
2000 g	6 t	HTS 6T-3AM	1270,-	167	1	○	●						●
2000 g	6 t	HFO 6T2M	1450,-	166	1	○	●						●
2000 g	10 t	HFT 10T2	1790,-	168	2*		●	●	●				●
5000 g	10 t	HFA 10T-3	1040,-	163	1		●					○	●
5000 g	10 t	HFC 10T-3	1350,-	164	1		●					○	●
5000 g	10 t	HTS 10T-3AM	1410,-	167	1	○	●						●
5000 g	15 t	HFT 15T5	2650,-	168	2*		●	●	●				●

■ = News 2016

2* = Delivery by truck, please ask for prices

● = Standard

○ = Option

Hanging scales KERN HDB-N · CH



KERN HDB-N



KERN CH



Convenient, economical and always handy

Features

- **1** With the TÜV certification mark, the scale meets the requirements of the standard EN 13155 (Non-fixed load lifting attachments/ Breakage resistance) and EN 61010-1 (Electrical safety)
- Ideal for rapid control in goods-in and goods-out
- Also essential in the private sector to determine the weight of fish, game, fruits, bicycle parts, suitcases etc.
- **Hold function:** For easy reading of the weighing result, the display can be „frozen“ in different ways. Either automatically when the weighing value remains unchanged or manually by pressing the Hold key

Technical data

HDB-N:

- **Hook (stainless steel)**, can be hinged
- **Ready for use:** Batteries included 2 x 1.5 V AAA, operating time up to 180 h, AUTO-OFF function to preserve the battery, can be switched off
- Further weighing units: kg, lb, N
- Permissible ambient temperature 5 °C / 35 °C

CH:

- **Hook (stainless steel)**
- **2 Tape measure**, extractable, length approx. 100 cm
- **Peak load display** (peak hold), measuring frequency 5 Hz

- **Ready for use:** 9 V block included, operating time up to 20 h. AUTO-OFF function to preserve the batteries, can be switched off
- Further weighing units: kg, lb, N
- Permissible ambient temperature 5 °C / 35 °C

Accessories

- **3 Tare pan with retaining bracket** suitable for KERN HDB-N and KERN CH 15K20, for details see page 182, KERN CH-A01N, € 67,-

STANDARD



OPTION



Model	Weighing range [Max] kg	Readout [d] g	LCD display, digit height mm	Dimensions housing WxDxH mm	Height with hook mm	Net weight approx. kg	Price excl. of VAT ex works €	Option DAkKS Calibr. Certificate	
								DKD KERN	€
KERN									
HDB 5K5N	5	5	12	70x25x105	195	0,15	60,-	963-127H	72,-
HDB 10K10N	10	10	12	70x25x105	195	0,15	60,-	963-128H	88,-
CH 15K20	15	20	11	90x30x176.5	270	0,25	71,-	963-128H	88,-
CH 50K50	50	50	11	90x30x176.5	270	0,25	76,-	963-128H	88,-
CH 50K100	50	100	11	90x30x176.5	270	0,25	66,-	963-128H	88,-

Hanging scales KERN HCB · HCN



KERN HCB

KERN HCN

The handy scales for higher loads up to 1 t

Features

- **1** With the TÜV certification mark, the scale meets the requirements of the standard EN 13155 (Non-fixed load lifting attachments/ Breakage resistance) and EN 61010-1 (Electrical safety)
- Ideal for rapid control in goods-in and goods-out
- Essential too in the private sector to determine the weight of fish, game, fruits, bicycle parts, suitcases etc.

- **Hold function:** For easy reading of the weighing result, the display can be „frozen“ in different ways. Either automatically when the weighing value remains unchanged or manually by pressing the Hold key
- **Peak load display** (peak hold), measuring frequency 5 Hz

Technical data

- LCD display, digit height 11 mm
- Hole diameter of load support, model with [Max] ≤ 200 kg: approx. 14 mm
[Max] > 200 kg: approx. 16 mm



HCB:

- **Ready for use:** Batteries included
3 x 1.5 V AA, operating time up to 300 h
- **2** HCB with [Max] ≥ 0,5 t: Reinforced version for heavy loads. Snap link and Hook not included

HCN:

- Housing stainless steel, IP65 protection
- **3** **Second display** on the rear of the balance
- **Ready for use:** 2 x 1.5 V AA, operating time up to 200 h

Accessories for models with [Max] ≤ 200 kg

- **Hook (stainless steel)** standard, opening approx. 25 mm, can be retrofitted, KERN HCB-A02, € 30,-
- **Snap link (stainless steel) with safety catch** standard, opening approx. 15 mm, can be retrofitted, KERN HCB-A01, € 33,-
Batteries included

Accessories for models with [Max] ≤ 20 kg

- **Tare pan with retaining bracket**, for details see page 182, KERN CH-A01N, € 67,-

STANDARD



OPTION



Model	Weighing range [Max] kg	Readout [d] g	Dimensions housing WxDxH mm	Height with snap link and hook mm	Net weight approx. kg	Price excl. of VAT ex works €	Option DAkKS Calibr. Certificate	
							DKD KERN	€
KERN								
HCB 20K10	20	10	80x45x150	290	0,4	105,-	963-128H	88,-
HCB 50K20	50	20	80x45x150	290	0,4	115,-	963-128H	88,-
HCB 50K100	50	100	80x45x150	290	0,4	90,-	963-128H	88,-
HCB 99K50	99	50	80x45x150	290	0,4	100,-	963-129H	105,-
HCB 100K200	100	200	80x45x150	290	0,4	110,-	963-129H	105,-
HCB 200K100	200	100	80x45x150	290	0,4	110,-	963-129H	105,-
HCB 200K500	200	500	80x45x150	290	0,4	99,-	963-129H	105,-
HCB 0.5T-3	500	1000	82x42.5x152	-	0,35	215,- 1	963-130H	165,-
HCB 1T-3	1000	2000	80x48x150	-	0,52	275,- 1	963-130H	165,-
stainless steel								
HCB 50K100IP	50	100	95x55x175	315	0,8	130,-	963-128H	88,-
HCB 100K200IP	100	200	95x55x175	315	0,8	130,-	963-129H	105,-
HCB 200K500IP	200	500	95x55x175	315	0,8	130,-	963-129H	105,-

1 Price reduction

Crane scale KERN HFA

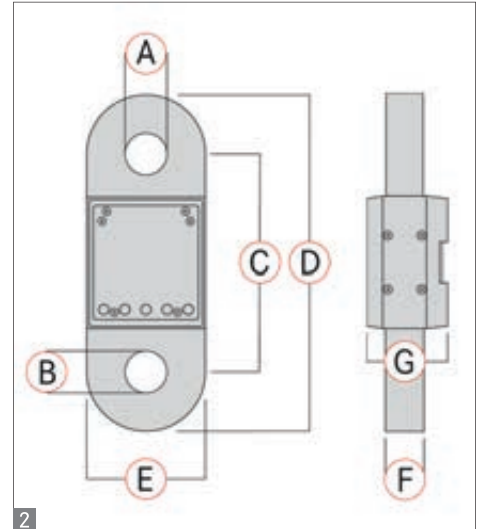

Compact crane scale with integrated display can also be used for tensile force measurement

Features

- With the TÜV certification mark, the scale meets the requirements of the standard EN 13155 (Non-fixed load lifting attachments/ Breakage resistance) and EN 61010-1 (Electrical safety)
- With its high-quality finish, low weight and compact dimensions, this crane scale (tensile force gauge) is an essential device for industrial use, on building sites, in freight centres, ports etc.
- Because of its compact design it is also ideally suited for installation in systems where space is limited, etc.
- Ideally suited for determining weight quickly while loading and unloading

- **Peak load display** (peak hold)
- **Hold function:** When the weighing value remains unchanged the weight indicated on the display is automatically „frozen“ until the HOLD key is pressed
- **Tare:** Resets the display to „0“ when there is a load on the scale. Now removed or added loads are directly displayed

Technical data

- Large backlit LCD display, digit height 23 mm
- Material and design of housing/load support, models with
[Max] ≤ 3 t: aluminium/stainless steel bearing
[Max] > 3 t: steel/steel

- Rechargeable battery pack internal, standard. Can be re-ordered, KERN HFA-A01, € 40,- operating time up to 30 h, charging time approx. 12 h, internal charging via mains adapter, charge status indicator on display
- Optional battery operation, 3 x 1.5 V AA not included, operating time up to 40 h
- Precision: 0,2 % of [Max]
- Measuring frequency: 60 Hz
- Further weighing units: kg, lb, N
- Permissible ambient temperature 5 °C / 35 °C

14

STANDARD



OPTION



Model	Weighing range [Max] kg	Readout [d] g	Dimensions						Net weight approx. kg	Price excl. of VAT ex works €	Option DAKKS Calibr. Certificate	
			A = B	C	D	E	F	G			DKD KERN	€
			mm	mm	mm	mm	mm	mm				
HFA 600K-1	600	200	27	165	255	90	30	55	1,8	590,-	963-130H	165,-
HFA 1T-4	1000	500	27	165	255	90	30	55	1,8	690,-	963-130H	165,-
HFA 3T-3	3000	1000	27	165	255	90	30	61	1,8	750,-	963-132H	500,-
HFA 5T-3	5000	2000	30	165	255	90	30	61	3,9	790,-	963-132H	500,-
HFA 10T-3	10000	5000	40	185	275	90	40	71	5,5	1040,-	963-133H	700,-

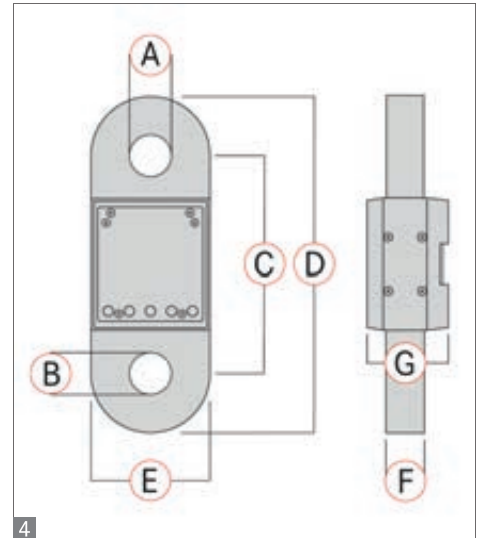

Compact crane scale for use in harsh environmental conditions or where space is limited, with convenient hand-held terminal

Features

- **1** With the TÜV certification mark, the scale meets the requirements of the standard EN 13155 (Non-fixed load lifting attachments/ Breakage resistance) and EN 61010-1 (Electrical safety)
- With its high-quality finish, low weight and compact dimensions, this crane scale (tensile force gauge) is an essential device for industrial use, on building sites, in freight centres, ports etc.
- Because of its **compact design** it is also ideally suited for installation in systems where space is limited, etc.
- **Peak load display** (peak hold)
- **Hold function:** When the weighing value remains unchanged the weight indicated on the display is automatically „frozen“ until the HOLD key is pressed

- **Tare:** Resets the display to „0“ when there is a load on the scale. Now removed or added loads are directly displayed
- **2 Display device with integrated radio module**, which the user can carry around with him, thanks to the convenient hand strap **3**. In this way the weighing data can always be read off the display device by the user, even when the user is a long way from the load receptor (force gauge) or under poor lighting conditions. Standard. Range up to 100 m. All functions can be selected. LCD display, digit height 23 mm, rechargeable battery pack internal, standard. Operating time up to 30 h without backlight, charging time approx. 12 h. Can be re-ordered, KERN HFC-A01, **€ 60,-**
- Dimensions Housing (display device) WxDxH 88x64x256 mm
- Net weight approx. 0,5 kg

Technical data

- Large backlit LCD display, digit height 23 mm
- Material and design of housing/load support, models with [Max] ≤ 3 t: aluminium/stainless steel bearing [Max] > 3 t: steel/steel
- Load lifting attachments: Optional battery operation, 3 x 1.5 V AA not included, operating time up to 40 h
- Precision: 0,2 % of [Max]
- Measuring frequency: 60 Hz
- Further weighing units: kg, lb, N
- Permissible ambient temperature 5 °C / 35 °C

Accessories

- **5 Rechargeable battery pack internal** for load lifting attachments, operating time up to 15 h, charging time approx. 12 h, KERN HFA-A01, **€ 40,-**

STANDARD

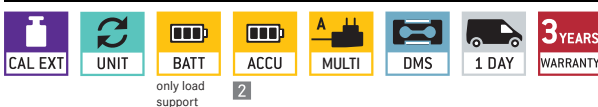

OPTION



Model	Weighing range [Max] kg	Readout [d] g	Net weight approx. kg	4 Dimensions						Price excl. of VAT ex works €	Option	
				A = B	C	D	E	F	G		DAkkS Calibr. Certificate	
				mm	mm	mm	mm	mm	mm		DKD KERN	€
KERN HFC 1T-4	1000	500	1,7	27	165	255	90	30	55	990,-	963-130H	165,-
KERN HFC 3T-3	3000	1000	2,2	27	165	255	90	30	61	1050,-	963-132H	500,-
KERN HFC 5T-3	5000	2000	3,9	30	165	255	90	30	61	1090,-	963-132H	500,-
KERN HFC 10T-3	10000	5000	6,0	40	185	275	90	40	71	1350,-	963-133H	700,-

Crane scale KERN HFB

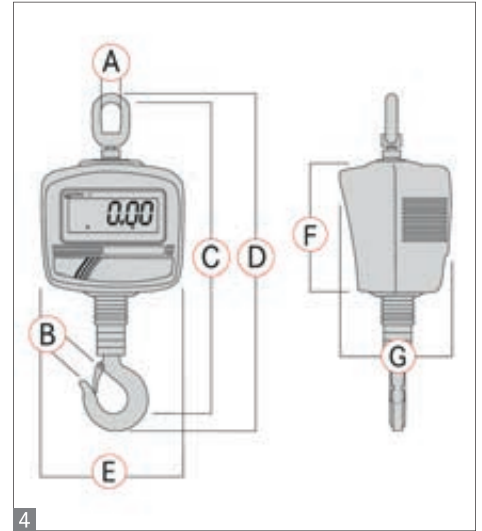

The professional alternative up to 600 kg with rear-facing second display

Features

- **1** With the TÜV certification mark, the scale meets the requirements of the standard EN 13155 (Non-fixed load lifting attachments/ Breakage resistance) and EN 61010-1 (Electrical safety)
- **2** **Second display** on the rear of the scale
- **High mobility:** thanks to battery operation, compact construction and low weight, it is suitable for use in several locations (production, warehouse, dispatch department etc.)
- **Hold function:** When the weighing value remains unchanged the weight indicated on the display is automatically „frozen“ until the HOLD key is pressed

- **Tare:** Resets the display to „0“ when there is a load on the scale. Now removed or added loads are directly displayed
- **Hook with safety catch,** revolving
- Shackle and hook connection made of nickel-plated steel
- **3** **Radio remote control** standard. Range up to 20 m. All functions can be selected (excl. ON/OFF). WxDxH 48x10x95 mm. Batteries included, 2 x 1,5 V AAA

Technical data

- Superior display size: digit height 25 mm. Bright backlight for easy reading of weight, even from a distance
- Dimensions housing WxDxH 162x123x158.5 mm
- Rechargeable battery pack internal, standard, operating time approx. 40 h, charging time approx. 14 h with mains adapter, charge status indication visualised through LED
- Precision: 0.2 % from [Max]
- Permissible ambient temperature 0 °C / 40 °C

STANDARD



OPTION



Model	Weighing range [Max] kg	Readout [d] g	Net weight approx. kg	4 Dimensions							Price excl. of VAT ex works €	Option DAKKS Calibr. Certificate	
				A mm	B mm	C mm	D mm	E mm	F mm	G mm		DKD KERN	€
KERN													
HFB 150K50	150	50	3,2	26	25	358	390	163	158,5	126	355,-	963-129H	105,-
HFB 300K100	300	100	3,2	26	25	358	390	163	158,5	126	385,-	963-129H	105,-
HFB 600K200	600	200	3,2	26	25	358	390	163	158,5	126	385,-	963-130H	165,-

Crane scales KERN HFM · HFO



KERN HFM



KERN HFO

NEW



1



2

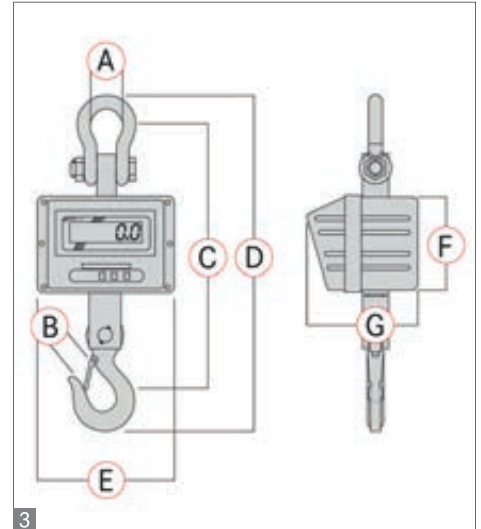

3

Industrial crane scale up to 10 t – now also with EC type approval [M]

Features

- With the TÜV certification mark, the scale meets the requirements of the standard EN 13155 (Non-fixed load lifting attachments/ Breakage resistance) and EN 61010-1 (Electrical safety)
- Professional device for robust applications** in production, quality control, logistics etc.
- Because of its stable construction and robust design, it is ideal for continuous use in industrial environment
- High mobility:** thanks to battery operation, compact construction and low weight, it is suitable for use in several locations (production, warehouse, dispatch department etc.)

- Adaptation to unstable environmental conditions by changing the readability
- High resolution readout: Readout [d] for 5 sec increased by one decimal place at the touch of a key, only for models with EC type approval
- Hold function:** When the weighing value remains unchanged the weight indicated on the display is automatically „frozen“ until the HOLD key is pressed
- Tare:** Resets the display to „0“ when there is a load on the scale. Now removed or added loads are directly displayed
- Hook with safety catch,** revolving
- Radio remote control** standard. Range up to 20 m. All functions can be selected (excl. ON/OFF). WxDxH 48x10x95 mm. Batteries included, 2 x 1,5 V AAA

Technical data

- Superior display size: digit height 30 mm. Luminescent LED display of weight values, even from a distance or under poor lighting conditions
- Rechargeable battery pack internal, standard, operating time up to 50 h, charging time approx. 14 h
- Precision: 0,2 % of [Max]
- Permissible ambient temperature -10 °C / 40 °C

14

STANDARD



OPTION



FACTORY



Model	Weighing range [Max] kg	Readout [d] g	Net weight approx. kg	3 Dimensions							Price excl. of VAT ex works €	Options			
				A	B	C	D	E	F	G		Verification		Calibr. Certificate	
				mm	mm	mm	mm	mm	mm	mm		MID KERN	€	DKD KERN	€
HFM 1T0.1	1000	100	13,2	80	40	540	610	270	200	175	710,-	-	-	963-130H	165,-
HFM 3T0.5	3000	500	15,7	75	50	540	610	270	200	175	740,-	-	-	963-132H	500,-
HFM 5T0.5	5000	500	22,3	75	50	650	730	300	230	190	960,-	-	-	963-132H	500,-
HFM 10T1	10000	1000	34	100	60	750	840	300	230	190	1250,-	-	-	963-133H	700,-
Note: For applications that require verification, please order verification at the same time, initial verification at a later date is not possible. Verification at the factory, we need to know the full address of the location of use.															
HFO 1.5T0.5M	1500	500	15	80	40	540	610	270	200	175	1020,-	950-130H	200,-	963-130H	165,-
HFO 3T1M	3000	1000	16,5	75	50	540	610	270	200	175	1150,-	950-132H	300,-	963-132H	500,-
HFO 6T2M	6000	2000	25	75	50	650	730	300	230	190	1450,-	on request	on request	963-132H	500,-

Crane scale KERN HTS

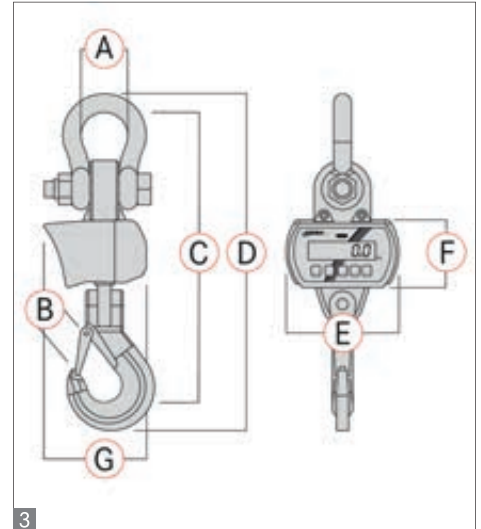

Robust industrial crane scale up to 10 t, with EC type approval [M]

Features

- With the TÜV certification mark, the scale meets the requirements of the standard EN 13155 (Non-fixed load lifting attachments/ Breakage resistance) and EN 61010-1 (Electrical safety)
- Professional device for robust applications** in production, quality control, logistics etc. Because of its stable construction and robust design, it is ideal for continuous use in industrial environment
- High mobility:** thanks to battery operation, compact construction and low weight, it is suitable for use in several locations (production, warehouse, dispatch department etc.)
- Range of tare: 100 % of [Max]

- LED display with Gross/Tare/Net
- Chargestatus indicator visualised through LED, visual using LED
- Standby function: display automatically switched off after 5 min without a change of load. Automatic activation with the touch of a key
- Tare:** Resets the display to „0“ when there is a load on the scale. Now removed or added loads are directly displayed
- Hook **with safety catch**, non-revolving
- Infrared remote control** standard. Range up to 8 m. All functions can be selected. WxDxH 65x24x100 mm. Batteries included, 9 V

Technical data

- Superior display size: digit height 25 mm. Large backlit LCD display for easy reading of the weight, even from a distance or under poor lighting conditions
- Rechargeable battery pack internal, standard, operating time up to 100 hours with backlight, charging time approx. 12 h. Can be re-ordered, KERN WTB-A01N, € 35,-
- Precision: 0,1 % of [Max]
- Net weight
 - HTS 1T-4AM approx 6,2 kg
 - HTS 3T-3AM approx 8,5 kg
 - HTS 6T-3AM approx 11,5 kg
 - HTS 10T-3AM approx 19,9 kg
- Permissible ambient temperature -20 °C / 40 °C

STANDARD



OPTION



FACTORY



Model	Weighing range [Max] kg	Readout [d] = [e] g	Minimum load [Min] kg	3 Dimensions							Price excl. of VAT ex works €	Options			
				A	B	C	D	E	F	G		Verification		Calibr. Certificate	
				mm	mm	mm	mm	mm	mm	mm		M KERN	€	DKD KERN	€
HTS 1T-4AM	1500	500	10	33	29	315	359	200	121	181	1140,-	950-130H	200,-	963-130H	165,-
HTS 3T-3AM	3000	1000	20	43	47	347	369	200	121	181	1200,-	950-132H	500,-	963-132H	500,-
HTS 6T-3AM	6000	2000	40	58	55	440	519	200	121	181	1270,-	950-132H	500,-	963-132H	500,-
HTS 10T-3AM	10000	5000	100	83	61	335	628	200	121	181	1410,-	950-133H	700,-	963-133H	700,-

Note: For applications that require verification, please order verification at the same time, initial verification at a later date is not possible. Verification at the factory, we need to know the full address of the location of use.

Crane scale KERN HFT

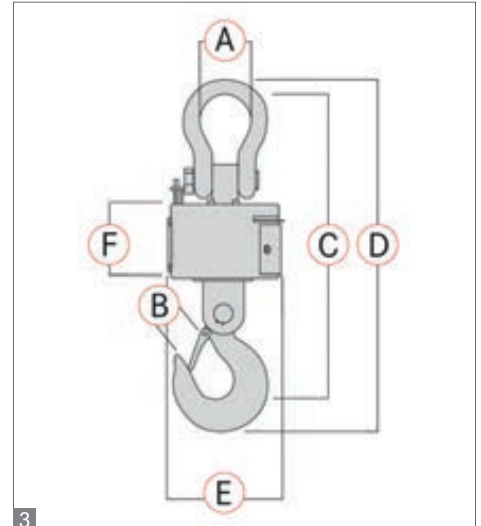

Robust industrial crane scale up to 15 t with radio display and RS-232 data interface for transferring weighing results

Features

- With the TÜV certification mark, the scale meets the requirements of the standard EN 13155 (Non-fixed load lifting attachments/ Breakage resistance) and EN 61010-1 (Electrical safety)
- Professional device for robust applications** in production, quality control, logistics etc. Because of its stable steel construction and robust design, it is ideal for continuous use in industrial applications
- Weighing unit without display**, therefore very robust
- Hold function:** When the weighing value remains unchanged the weight indicated on the display is automatically „frozen“ until the HOLD key is pressed
- Hook with safety catch**, revolving

- Display with integrated radio module**, in this way the weighing data can easily be read off the display by the user, even if the user might find himself in a remote distance from the crane scale. Range up to 100 m. The integrated RS-232 data interface allows from connection to a printer, PC or network

Technical data

- Separate display with large, backlit LCD display, digit height 22 mm. Dimensions WxDxH 175x135x39 mm, incl. antenna WxDxH 240x135x55 mm
- Precision: 0,2 % of [Max]
- Permissible ambient temperature 0 °C / 40 °C

Accessories

- Rechargeable battery pack internal**, standard. Can be re-ordered, scale: operating time up to 80 h, charging time approx. 8 h. Can be re-ordered, KERN VFB-A02, **€ 40,-**
- display device: operating time up to 40 h, charging time 4 h. Can be re-ordered, KERN GAB-A04, **€ 40,-**
- Interface cable RS-232**, to connect the display device to a printer, PC, etc., cable length approx. 1,5 m, KERN KFF-A01, **€ 46,-**
- Suitable printers** see page 177

14

STANDARD



OPTION



Model	Weighing range [Max] kg	Readout [d] g	Net weight approx. kg	3 Dimensions						Price excl. of VAT ex works €	Option DAkkS Calibr. Certificate	
				A	B	C	D	E	F		DKD KERN	€
KERN				mm	mm	mm	mm	mm	mm			
HFT 3T0.5	3000	500	28	73	39	545	650	270	145	1200,-	963-132H	500,-
HFT 5T1	5000	1000	45	76	51	635	760	270	147	1440,-	963-132H	500,-
HFT 10T2	10000	2000	53	92	61	735	840	270	167	1790,-	963-133H	700,-
HFT 15T5	15000	5000	73	99	61	842	950	320	160	2650,-	963-133H*	700,-

* Calibration up to [Max] = 12 t

Special equipment: Scales to meet Pre-packaging legislation

Pre-packaging legislation (FPVO)

This is anchored in the EC pre-packaging directive 76/211/EEC and serves as consumer protection within the framework of weights and measures laws when selling pre-packaged products commercially. It governs in detail the permitted tolerances (deviations) from the filling quantity stated on the sales label, as well as the quality of the verified balances being used for checking samples.

Pre-packaged products, which are produced and tested in accordance with pre-packaging legislation, carry the E symbol on their label.

Choosing the right verified checkweigher depends, on one hand, on the weighing range required and the largest permitted verification value in relation to the nominal quantity of the pre-packaged goods.

Nominal contents Q_N of the pre-packed goods	largest permitted Verification Value [e]
$\leq 10 \text{ g (ml)}$	0,1 g
from 10 g (ml) to $\leq 50 \text{ g (ml)}$	0,2 g
from 50 g (ml) to $\leq 150 \text{ g (ml)}$	0,5 g
from 150 g (ml) to $\leq 500 \text{ g (ml)}$	1,0 g
from 500 g (ml) to $\leq 2,5 \text{ kg (l)}$	2,0 g
from 2,5 kg (l) and more	5,0 g
from 10 kg (l) to $\leq 15 \text{ kg (l)}$	10 g
from 15 kg (l) to $\leq 25 \text{ kg (l)}$	20 g
from 25 kg (l) to $\leq 100 \text{ kg (l)}$	50 g

Volume values in ml or l are calculated using the weight and density of the liquid.

Order example:

The item to be checked is a pre-packaged product with a filling quantity of 250 g and an average tare value of 100 g. In accordance with the table above, a filling quantity of 250 g requires a checkweigher with a verification value [e] of maximum 1 g.

The right KERN product is either the **KERN FKTF 3K0.5LM** or the **FKTF 6K1LM**

Calibration periods for checkweighers: These are usually 1 year and are therefore shorter than the general re-verification periods in many European countries.



Sample testing of a pre-packaged item with an average tare value, e.g. the relative constant packaging weight is entered as a fixed value



Sample testing of a pre-packaged item with fluctuating packaging weight, such as glass containers, e.g. the tare weight is entered individually for each sample.



Sample testing of a pre-packaged item which is empty (destructive analysis)



Sven Göggel

Product specialist Scales to meet Pre-packaging legislation

Tel. +49 [0] 7433 9933-189

Fax +49 [0] 7433 9933-195

goeggel@kern-sohn.com

Quick-Finder Scales to meet Pre-packaging legislation

Read-out [d]	Weighing range [Max]	Model KERN	Price excl. of VAT ex works €	Page	DAYS ready for shipping					
0,5 g	3 kg	FKTF 3K0.5LM	1050,-	170	1	○	●	●	●	●
1 g	6 kg	FKTF 6K1LM	1050,-	170	1	○	●	●	●	●
2 g	12 kg	FKTF 12K2LM	1050,-	170	1	○	●	●	●	●
5 g	30 kg	FKTF 30K5LM	1050,-	170	1	○	●	●	●	●
10 g	60 kg	FKTF 60K10LM	1050,-	170	1	○	●	●	●	●

● = Standard

○ = Option

Pre-packaged Products Control Scale KERN FKTF



Modes

- ① Weighing
- ② Checkweighing function in accordance with pre-packaging legislation
- ③ Controlling fill quantities

Functions

- Capacity display ①
- Date and time ①, ②, ③
- Tare deduction ②
- 400 item memories for master data, such as limit values, tare weights, items, machine, user as well as UL, LL, LL 1 and LL 2 ②, ③
- Sample testing in accordance with pre-packaging legislation with average tare value ③
- Sample testing in accordance with pre-packaging legislation with fluctuating tare ③
- Testing in accordance with pre-packaging legislation with an empty item (destructive analysis) ②, ③
- Daily statistics from 10 sets of measurements ③
- Weekly statistics from 49 sets of measurements ③

Checkweigher with touch screen operation for sampling tests in accordance with certified pre-packaging legislation and controlling fill quantities in the production process

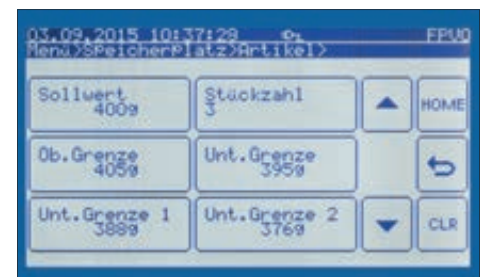
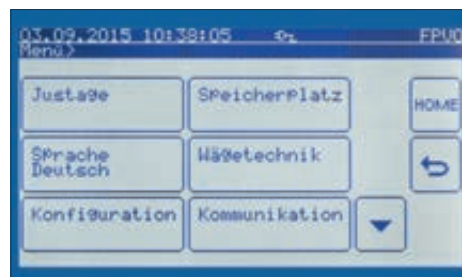
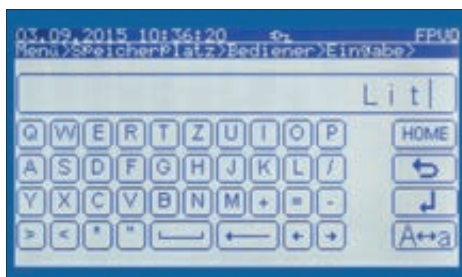

Easy input of text and values

Using large keypad, e.g. packaging weights, item descriptions, user name, etc.

Clear user guidance with buttons labelled with plain text, which saves time and means that operating errors are avoided

400 item memories for master data such as PRE-TARE (packaging weight), free limit values, user name, machine number, batch description etc.

Pre-packaged Products Control Scale KERN FKTF

Features

- **Touchscreen bench scale** with special software for testing, in accordance with weights and measures regulations, that the permitted error limits (minus deviations) have been observed, in accordance with pre-packaging legislation, and for production control and monitoring when filling pre-packaged items to a target weight.
- **The verifiable KERN FKTF** fulfills all the regulations of pre-packaging legislation. It has EC type approval which fulfils verification requirements, and which covers the special software for pre-packing legislation.
- **The special software for pre-packaging legislation in the KERN FKTF has two functions:**
 - a) When selling pre-packaged products, filling tolerances are regulated in verification terms, in the interests of consumer protection. Here the software supports compliance with the verification regulations of the pre-packaging legislation during certified sampling tests using the automatically generated largest permitted negative deviation compared with a given target weight (LL 2).
 - b) In the area of food stuff production, when setting and adjusting the production facility for filling pre-packaged goods to a target weight, the software will automatically display the lower limit value (LL 1) below which the item is not permitted.
- **Statistical function** in the form of daily and weekly records, also with date/time, machine number and user statement. Graphic display is also possible.
- **Password protection** for secure manipulation of data which has been stored and collected

Technical data

- Backlit LCD graphic display with digit height 18 mm, screen diagonal 5.8" (approx. 147 mm)
- Weighing plate dimensions, stainless steel, WxD 340x240 mm
- Dimensions housing WxDxH 350x390x120 mm
- Optional battery operation, 6 x 1.5 V Size C not included, operating time up to 15 h
- Net weight approx. 6,5 kg
- Permissible ambient temperature 10 °C / 40 °C

Accessories

- **Protective working cover** over keyboard and housing, standard. Can be re-ordered, scope of delivery: 5 items, KERN FKB-A02S05, € 25,-
- **Matrix needle printer**, to print the weights on normal paper, ideal for long-term archiving, KERN 911-013, € 330,-
- **Suitable printers** see page 177

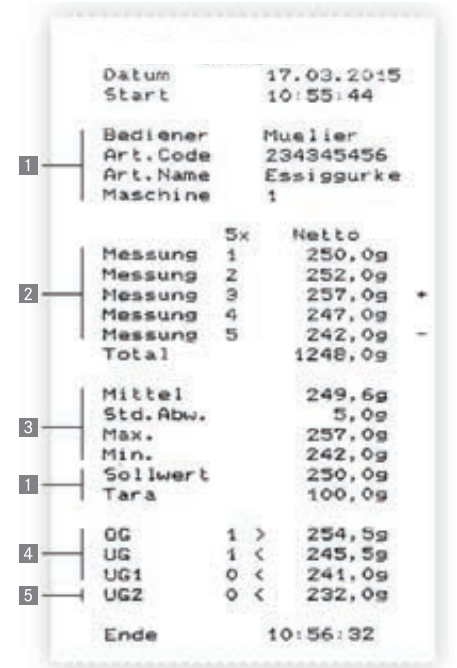

- **1** Operator, Item code, Item name, Machine, Filling quantity target value 250g, Average tare value 100g are entered using the touchscreen keypad
- **2** The measurements taken are captured and stored automatically
- **3** Average value, Standard deviation, Max. value, Min. value are calculated automatically
- **4** The upper/lower limit values (UL/LL) for setting and adjusting the production facility are stored by the machine operator in the pre-packaging legislation software of the checkweigher. In the course of checking pre-packaged items in accordance with pre-packaging legislation, please note that the value must not fall below the lower limit value LL 1 during production
- **5** The LL 2 value is the permitted lower limit in accordance with pre-packaging legislation for on-site sampling tests in accordance with weights and measures regulations.

STANDARD



OPTION



FACTORY



Model	Weighing range [Max] kg	Readout [d] g	Verification value [e] g	Minimum load [Min] g	Nominal quantity g	Price excl. of VAT ex works €	Option			
							Verification		DAkks Calibr. Certificate	
							M KERN	€	DKD KERN	€
FKTF 3K0.5LM	3	0,5	0,5	10	50	1050,-	950-127	55,-	963-127	72,-
FKTF 6K1LM	6	1	1	20	150	1050,-	950-128	55,-	963-128	88,-
FKTF 12K2LM	12	2	2	40	500	1050,-	950-128	55,-	963-128	88,-
FKTF 30K5LM	30	5	5	100	2500	1050,-	950-128	55,-	963-128	88,-
FKTF 60K10LM	60	10	10	200	10000	1050,-	950-129	93,-	963-129	105,-

Note: For applications that require verification, please order verification at the same time, initial verification at a later date is not possible. Verification at the factory, we need to know the full address of the location of use.

ATEX – Safe weighing in potentially explosive atmospheres!

ATEX is derived from the French words for explosive atmosphere (**AT**mosphère **EX**plosible) and is a synonym for EU guidelines, for the quality and the use of equipment in hazardous industrial environments

ATEX balances were developed specifically for those areas where there is explosion danger, e.g. through handling of flammable substances, which are present in high concentrations in the form of gas, mist, vapour or dust.

Typical fields of application are to be found, for example, in the crude oil processing industry, e.g. in all kinds of refineries. But also in the pharmaceutical or chemical industries, where you are processing oils, alcohols or Benzenes, in the manufacture of paints and lacquers, as well as in the cosmetics industry in the manufacture of alcohol-based cosmetics.

Note: Power supply to the ATEX scales is from a power source outside the explosion-proof area.



Taras Mikitisin

Product specialist ATEX scales

Tel. +49 [0] 7433 9933- 143

Fax +49 [0] 7433 9933- 137

mikitisin@kern-sohn.com

ATEX balances are divided into different protection classes, depending on the level of danger.

The KERN ATEX balances are permitted for the following protection classes:

Model KERN IEX: **II 2 G II B T4**

Model KERN OEX: **II 2 G II C T4**

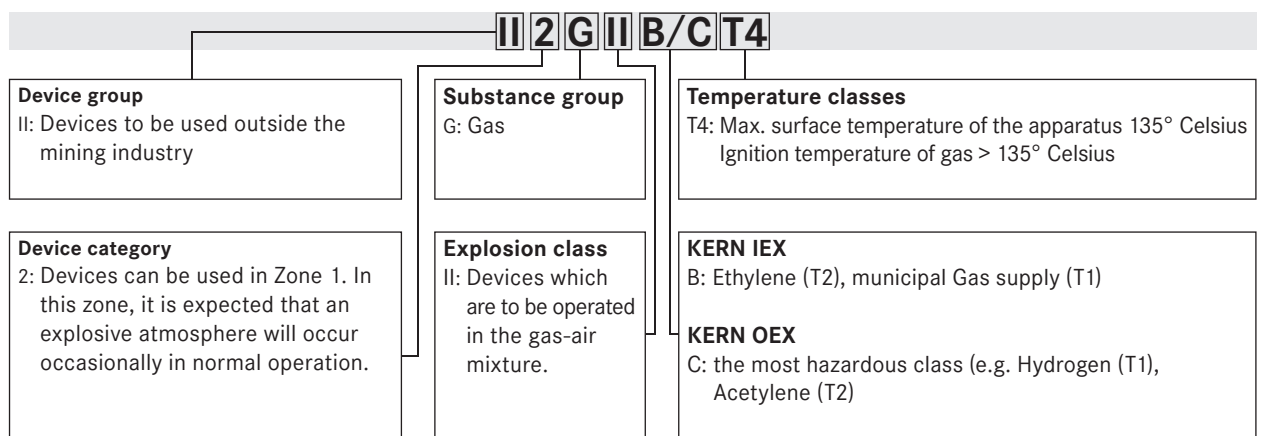

Quick-Finder ATEX scales

Read-out	Weighing range	Model	Price excl. of VAT ex works €	Page	DAYS ready for shipping							
[d]	[Max]	KERN				For an explanation on the pictos, see the front flap						
2 g	6 kg	IEX 6K-3M	1950,-	173	20	● IIB	○	●	●	●	●	●
2 g	6 kg	OEX 6K-3M	4330,-	174	20	● IIC	○	●	●	●	●	●
2 g	6 kg	OEX 6K-3HM	4330,-	174	20	● IIC	○	●	●	●	●	●
5 g	15 kg	IEX 10K-3M	1950,-	173	20	● IIB	○	●	●	●	●	●
5 g	15 kg	OEX 10K-3M	4330,-	174	20	● IIC	○	●	●	●	●	●
5 g	15 kg	OEX 10K-3HM	4330,-	174	20	● IIC	○	●	●	●	●	●
10 g	30 kg	IEX 30K-2M	2150,-	173	20	● IIB	○	●	●	●	●	●
10 g	30 kg	OEX 30K-2M	4730,-	174	20	● IIC	○	●	●	●	●	●
10 g	30 kg	OEX 30K-2HM	4730,-	174	20	● IIC	○	●	●	●	●	●
20 g	60 kg	IEX 60K-2M	2150,-	173	20	● IIB	○	●	●	●	●	●
20 g	60 kg	OEX 60K-2M	5690,-	174	20	● IIC	○	●	●	●	●	●
20 g	60 kg	OEX 60K-2HM	5690,-	174	20	● IIC	○	●	●	●	●	●
50 g	150 kg	IEX 100K-1M	2850,-	173	20	● IIB	○	●	●	●	●	●
50 g	150 kg	OEX 100K-1M	5690,-	174	20	● IIC	○	●	●	●	●	●
50 g	150 kg	OEX 100K-1HM	5690,-	174	20	● IIC	○	●	●	●	●	●

● = Standard

○ = Option



Platform scale with ATEX approval in explosion class II B, with EC type approval [M]

Features

- **Class of protection II 2 G II B T4**, see page 172
- **Stainless steel weighing plate**, painted steel base **1**
- **2 Weighing platform** with dust and spray protection IP65
- **Load cell** aluminium, **silicone-coated**
- **3 Stainless steel display device**, protection against dust and water splashes IP67

Technical data

- Backlit LCD display, digit height 18 mm
- Weighing plate dimensions, stainless steel, WxDxH
 - A** 500x400x105 mm
 - B** 500x400x105 mm
- Dimensions of display device WxDxH 170x172x76 mm (incl. benchtop stand: WxDxH 226x250x120 mm)
- Cable length of display device, shielded and fail safe, 6-core, length approx. 2,5 m
- Permissible ambient temperature -10 °C / 40 °C

4 Power supply using power supply outside the explosion-proof area using a 20 m long cable with **5** screw coupling to fix the display device. Power supply included with delivery. Please indicate the type required at purchase, e.g.:
 European power supply: IEX 6K-3MEU
 UK power supply: IEX 6K-3MUK

STANDARD

OPTION

+3 DAYS

FACTORY

Model	Weighing range [Max] kg	Readout [d] g	Verification value [e] g	Minimum load [Min] g	Net weight approx. kg	Weighing plate	Price excl. of VAT ex works €	Options			
								Verification		DAkkS Calibr. Certificate	
								KERN	€	DKD KERN	€
IEX 6K-3M	6	2	2	40	9,5	A	1950,-	965-228	55,-	963-128	88,-
IEX 10K-3M	15	5	5	100	9,5	A	1950,-	965-228	55,-	963-128	88,-
IEX 30K-2M	30	10	10	200	18,5	B	2150,-	965-228	55,-	963-128	88,-
IEX 60K-2M	60	20	20	400	18,5	B	2150,-	965-229	93,-	963-129	105,-
IEX 100K-1M	150	50	50	1000	18,5	B	2850,-	965-229	93,-	963-129	105,-

Note: For applications that require verification, please order verification at the same time, initial verification at a later date is not possible. Verification at the factory, we need to know the full address of the location of use.



KERN OEX-HM



KERN OEX-M



2 Power supply using power supply outside the explosion-proof area using a 20 m long cable with screw coupling to fix the display device. Power supply included with delivery. Please indicate the type required at purchase, e.g.:
European power supply: IEX 6K-3MEU
UK power supply: IEX 6K-3MUK

Platform scale with ATEX approval in explosion class II C, with EC type approval [M]

Features

- **Class of protection II 2 G II C T4**, see page 172
- **Stainless steel weighing plate**, stainless steel substructure **1**
- **Weighing platform** with dust and spray protection IP65
- **Load cell** aluminium, **silicone-coated**
- Stainless steel **display device**, protection against dust and water splashes IP67
- Column to screw on to the platform, standard for models OEX-HM

Technical data

- Backlit LCD display, digit height 18 mm
- Weighing plate dimensions, stainless steel, WxDxH
 - A** 250x300x155 mm
 - B** 250x300x155 mm, see enlarged picture
 - C** 250x300x155 mm
- Dimensions of display device WxDxH 170x172x76 mm (only OEX-M: incl. benchtop stand: WxDxH 226x250x120 mm)

- only OEX-HM: Height incl. fitted column, approx. 790 mm
- Cable length of display device, shielded and fail safe, 6-core, length approx. 2,5 m
- Permissible ambient temperature -10 °C / 40 °C

STANDARD



OPTION



FACTORY



Model	Weighing range [Max] kg	Readout [d] g	Verification value [e] g	Minimum load [Min] g	Net weight approx. kg	Weighing plate	Price excl. of VAT ex works €	Options			
								Verification		DAkkS Calibr. Certificate	
								M III KERN	€	DKD KERN	€
OEX 6K-3M	6	2	2	40	9	A	4330,-	965-228	55,-	963-128	88,-
OEX 10K-3M	15	5	5	100	9	A	4330,-	965-228	55,-	963-128	88,-
OEX 30K-2M	30	10	10	200	11	B	4730,-	965-228	55,-	963-128	88,-
OEX 60K-2M	60	20	20	400	17	C	5690,-	965-229	93,-	963-129	105,-
OEX 100K-1M	150	50	50	1000	17	C	5690,-	965-229	93,-	963-129	105,-
with elevated display											
OEX 6K-3HM	6	2	2	40	9,5	A	4330,-	965-228	55,-	963-128	88,-
OEX 10K-3HM	15	5	5	100	9,5	A	4330,-	965-228	55,-	963-128	88,-
OEX 30K-2HM	30	10	10	200	11,5	B	4730,-	965-228	55,-	963-128	88,-
OEX 60K-2HM	60	20	20	400	18	C	5690,-	965-229	93,-	963-129	105,-
OEX 100K-1HM	150	50	50	1000	18	C	5690,-	965-229	93,-	963-129	105,-

Note: For applications that require verification, please order verification at the same time, initial verification at a later date is not possible. Verification at the factory, we need to know the full address of the location of use.

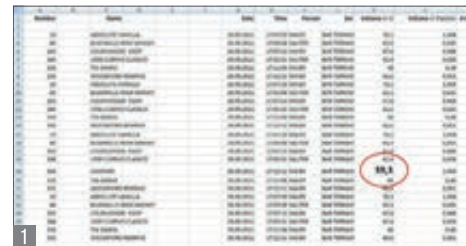

Stocktaking scale with touchscreen for efficiently measuring beverage residuals in bottles and for transferring information to the PC

Features

- **Your advantage:** Less time consuming, compared with the measuring method used before
 - Up to now: Generally, the content of a bottle is established by a visual check, e.g. estimated, documented manually and then manually entered into the PC.
 - New with KERN SMT: Now you can easily select drinks and spirits by item name, item number, autolist or using a barcode scanner, then you can weigh the bottle, transfer the results to the PC - and stocktaking is done!
- **400 item memories** for master data such as item name, item description, PRE-TARE, e.g. weight of the empty bottle, max. bottle content in g, specific weight of liquid etc. The associated stock list can easily be generated at the PC
- **Easy entering of items at the PC:** An excel list with spirit bottles produced at a PC can be transferred to the balance using the software included as standard. Whether in the bar or in the warehouse, the spirits can be weighed in their bottles. In doing so, the stored bottle weight will be subtracted automatically.

After the stocktaking, the results will be transferred back to the PC where they can then be processed further as an Excel table

- Determination of beverage inventory according to an internal stock list
- **Selecting the spirit:** During stocktaking, the beverage to be registered can be selected using item name, item number, autolist or using a barcode scanner

Technical data

- Backlit LCD graphic display with digit height 13 mm, screen diagonal 4,3" (approx. 109 mm)
- Weighing plate dimensions, stainless steel, WxD 160x200 mm
- Overall dimensions WxDxH 180x310x85 mm
- **Rechargeable battery pack internal**, standard, operating time up to 12 h without backlight, charging time approx. 10 h
- Net weight approx. 2,7 kg
- Permissible ambient temperature 10 °C / 40 °C

Modes

- ① Weighing
- ② Determination stock level

Functions

- Capacity display with ①, ②
- PRE-TARE from the memory unit with ①, ②
- Date/time with ①, ②
- GLP printout with ①, ②
- Data transfer of stock items from PC → Stocktaking scale from Excel list with ②
- Transfer of the stocktake information from stocktaking scale → PC as an Excel list with ②
- Selection of stock location and user with ②

Accessories

- **Protective working cover** over keyboard and housing, standard. Can be re-ordered, scope of delivery: 5 items, KERN 572-A02S05, **€ 35,-**
- **Volume kit** for determining the specific weight of beverages, scope of delivery: precision balance KERN EMB 600-2, beaker, pipette, KERN SMT-A05, **€ 850,-**
- **Barcode scanner**, table-top version, dimensions WxDxH 230x150x135 mm, KERN SMT-A02, **€ 685,-**
- **Barcode scanner**, hand-held version, dimensions WxDxH 235x210x115 mm, KERN SMT-A03, **€ 445,-**
- **Radio barcode scanner**, hand-held version, dimensions WxDxH 225x220x110 mm, KERN SMT-A04, **€ 495,-**

STANDARD

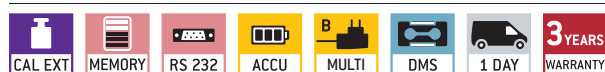

OPTION



Model	Weighing range	Readout	Reproducibility	Linearity	Price excl. of VAT ex works	Option	
						DAkKS Calibr. Certificate	
KERN	[Max] kg	[d] g	g	g	€	DKD KERN	€
SMT 10K-3	10	1	0,5	± 0,5	950,-	963-128	88,-

! Laptop and decorative items not within the scope of delivery

! ONLY WHILE STOCKS LAST !

For more information, please visit kern-sohn.com/en/SMT · Order hotline +49 [0] 7433 9933-0

Special equipment 175

WLAN interface

Printers

Stands



Weighing table

Tare pans



USB keyboard

Protective dust cover



Relay output

Transport case

Wall mount



Large displays

Barcode scanner

Foot switch



Interface cable

Second display

Digital I/O interface



Printers

Important note for printer orders: Please state your balance model when ordering, so that the printer can be preconfigured in the factory to suit your balance.

STANDARD

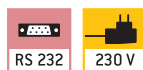

KERN 911-013

Matrix needle printer

For printing weighing results on normal paper, which is ideal for long-term archiving.

Technical data

- Needle print
- Speed: 1,8 line/sec
- Max. 40 characters per line
- Paper stripes: 57 mm wide
- Operation via mains adapter 230V/50Hz (standard EU), as standard

- Dimensions housing: WxDxH 100x180x106 mm
- Interface cable not included with delivery

Price printer without interface cable, KERN 911-013, **€ 330,-**

Accessories

- Paper rolls (10 pcs.), KERN 911-013-010, **€ 35,-**
- Universal mains adapter, standard EU/GB, USA, KERN ABS-A01, **€ 72,-**

STANDARD

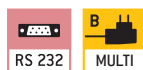

KERN YKN-01

Matrix needle printer

For printing weighing results on normal paper, which is ideal for long-term archiving.

Technical data

- Needle print
- Speed: 1 line/sec
- Max. 16 characters per line
- Paper stripes: 44 mm wide
- Operation via mains adapter 230V/50Hz, as standard

- Dimensions housing: WxDxH 158x106x40 mm
- Interface cable not included with delivery

Price printer without interface cable, KERN YKN-01, **€ 225,-**

Accessories

- Paper rolls (5 pcs.), KERN YKN-A01, **€ 35,-**

STANDARD



KERN YKB-01N

Thermal printer

For printing weighing results, recipes, quantities etc. or for GLP record keeping of balance adjustment with date and time print. Language versions: DE, GB, FR.

Technical data

- Thermal print
- Speed: 0,75 lines/sec
- Max. 40 characters per line
- Paper stripes: 112 mm wide
- Operation via mains adapter 230V/50Hz, as standard

- Dimensions housing: WxDxH 165x140x50 mm
- Interface cable not included with delivery

Price printer without interface cable, KERN YKB-01N, **€ 325,-**

Accessories

- Paper rolls (10 pcs.), KERN YKB-A10, **€ 55,-**

Individual header data:

For printers **KERN YKN-01, YKB-01N** the free software **KERN SHM-01** (see www.kern-sohn.com) can be used to print 4 header lines on the printout (see marking on balance).

Compatible models: KERN 440, DE, FCB, FKB-A, PCB, PCD.

STANDARD



KERN YKS-01

Thermal statistics printer

For printing weighing results, recipes etc. or for GLP record keeping of weighing data with date and time print (not in combination with KERN counting scales or KERN MLS, MLB moisture analysers).

Numerator; with statistical functions such as count and total of all measurements, minimum and maximum values of the main unit, range (Max-Min), average value, standard deviation, available units: mg, g, kg, pcs. Language versions: DE, GB, FR.

- Paper stripes: 112 mm wide
- Operation via mains adapter 230V/50Hz (standard)
- Dimensions: WxDxH 165x140x50 mm
- Interface cable not included with delivery

Price printer without interface cable, KERN YKS-01, **€ 390,-**

Accessories

Paper rolls (10 pcs.), KERN YKB-A10, **€ 55,-**

Technical data

- Thermal print
- Speed: 0,75 lines/sec
- Max. 40 characters per line

STANDARD



NEW



KERN YKE-01

Thermal label printer

Affordable universal label printer to print out weighing results on thermal labels, compatible with all KERN 2016 balances. ASCII-capable.

Price printer without interface cable, KERN YKE-01, **€ 590,-**

Accessories

- Paper roll (1 pcs.),
Dimensions labels: WxD
51x30 mm, 290 labels: KERN YKE-A01, **€ 60,-**
73x61 mm, 140 labels: KERN YKE-A02, **€ 60,-**
105x48 mm, 65 labels: KERN YKE-A03, **€ 60,-**

Technical data

- Thermal print
- Speed: 22 mm/s
- Max. 82 characters per line
- Paper stripes: 112 mm wide
- Operation via mains adapter 230V/50Hz, as standard
- Dimensions housing:
WxDxH 150x155x65 mm
- Interface cable not included with delivery

STANDARD



KERN YKC-01

Bluetooth thermal printer

For printing weighing results, recipes, etc. or for GLP record keeping of weighing data. Suitable for wireless connection to compatible, Bluetooth-enabled balances (Kern: DLT-N or all models with RS-232 data interface in combination with RS-232/Bluetooth adapter KERN YKI-02), dynamometers, etc.

- Operation via mains adapter 230V/50Hz, as standard
- Dimensions housing:
WxDxH 85x113x57 mm
- Interface cable not included with delivery

Price printer without interface cable, KERN YKC-01, **€ 690,-**

Accessories

Paper rolls (10 pcs.), KERN YKC-A01, **€ 35,-**

Technical data

- Thermal print
- Speed: 60 mm/sec
- Max. 42 characters per line
- Paper stripes: 57 mm wide

Interface cable for RS-232

For direct connection to a printer or PC, cable length approx. 1.5 m. The interface parameters can be set using the balance keypad.

Note:

The interface cable is **free of charge** if you purchase balance, printer or Ethernet-/WLAN-/Bluetooth adapter together.

Printer, ... →	PC, YKI-01/-02/-03	911-013, YKE-01, YKB-01N, YKN-01	YKS-01	Cable Price excl. of VAT ex works €
Balance ↓	Product code	Product code	Product code	
440, 572, 573, ALJ-AM, ALS-A, ALT-B, CDS, CKE, DE-D, DS, EMB-V, FCB, FKB, FKB-A, FKT, FKTF, IKT, KB, PCB, PCD, PKS, PKT, PLJ-A, PLJ-F, PLS-A, PLS-F, PLE, PLT		572-926		46,-
DBS, DLB, DLT, DAB		572-926	-	
BFA, BFB, EWJ, GAB-N, GAB-P, IFB, KFB-TM, NFB, PFB, UFB		CFS-A01		
BFS, CCS, CFS, CPB KFS-TM, IFS (from year of production 2015)		CFS-A01		
EG-N, EW-N		474-926		
PEJ, PES (printer connection unidirectional)	-	474-926		
PEJ, PES (printer/PC connection bidirectional)		MLB-A05		
ADB, AEJ-CM, AEJ-NM, AES-C, AES-N, AET, CCP, ILJ-C, ILS-C, ILT, PET, PLJ-C, PLJ-G, PNJ, PNS		MLB-A05		
KFS-T, MLS-D		MLB-A05	-	
HFT		KFF-A01		
ABT-N, PBJ, PBS		770-926		
ABJ-NM, ABS-N		ACS-A01		
CCT		KET-A09		120,-



KERN SCD-4.0

Balance Connection Software

For the direct transmission of weighing data to Windows applications (operating systems Windows XP, Vista, 7, 8, 10).

New: many additional applications, which will help to make the daily work with your balance easier.

- Transfer via RS-232, Bluetooth, LAN or WLAN (TCP/UDP/IP) to applications or files on the PC or in networks, e.g. to MS Excel, Access or Word
- Background transfer at the touch of a key or on a time-controlled basis
- Any output formatting of the transferred data is possible
- Any sequence, if applicable, calculations are possible, etc.)
- Automatic file-naming
- Recording of date and time for every value transferred

- Several output options (e.g. On-Screen display, Excel and file), is also possible simultaneously
- Parallel recording of data from several balances in a table simultaneously
- Large display of the latest recorded value on the display, for maximum transparency
- The interface protocols for KERN balances are already predefined
- Interface cable included. Please specify balance model when ordering (see interface cable table)

Benefits:

- Typing errors during e.g. manual transfer are avoided
- Automatic recording, e.g. for long-term tests
- GLP-compliant lab software

KERN SCD-4.0, € 150,-

KERN PET-A16

Alibi memory software

Alibi memory software for viewing and saving data from the alibi memory onto a PC connected to the system, suitable for series

KERN AEJ-C, ILJ-C, PLJ-C,

KERN PET-A16, € 300,-



KERN PLJ-A06

WLAN interface

WLAN interface for wireless connection of the balance to networks and WLAN capable devices, such as tablets, laptops, smartphones or networks, must be ordered at purchase,

suitable for series KERN AEJ-C, AES-C, ILJ-C, ILS-C, PLJ-C,

KERN PLJ-A06, € 135,-

Accessories

STANDARD

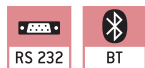

KERN YKI-02

RS-232 / Bluetooth adapter

Adapter for the wireless connection of balances, force measuring devices etc. with an RS-232 interface to Bluetooth devices, such as Bluetooth printers (e.g. KERN YKC-01), tablets, laptops, Smartphones etc. In this way, where there is a physical separation or a large distance between the devices, the weighing data from one or several balances can be easily sent without cable and printed on a Bluetooth printer or transferred to a Bluetooth device (you would need the relevant software on the Bluetooth device, not included with the delivery). The compact adapter with its attractive design can usually be connected directly to the balance **1**, e.g. an additional interface cable would not be necessary. Bluetooth adapter will

be powered by the balance (if compatible) or with the mains adapter which is supplied as standard **2**.

Range up to 100 m outside, depending on obstacles, such as, walls, the sensitivity and type of antenna of the receiver. Intersections of sending and receiving lines using the DCE/DTE switch **3**. **Compatible with KERN BalanceConnection software.**

Scope of delivery: RS-232/Bluetooth adapter, mains adapter (EU/UK/USA/AUS/CH) **2**, USB-A to Mini-USB-B cable **4**, gender changer **5**, driver CD.

Price interface cable incl.,
KERN YKI-02, € 260,-

STANDARD

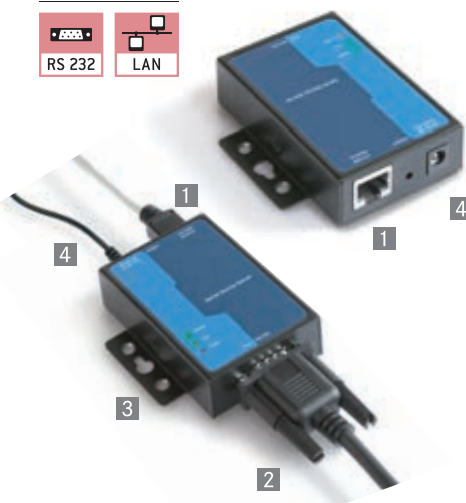
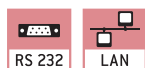

KERN YKI-01

RS-232 / Ethernet adapter

Adapter to connect balances, force measuring devices etc. with an RS-232 interface **2** to an IP-based Ethernet network **1**. The adapter allows direct integration of measuring devices into most company networks, with automatic configuration using DHCP or statistical IP allocation. You can access the current measuring data at any time from within the whole network, without having to use additional cables. The adapter supports a wide range of configurational options using the enclosed administration software or by the web interface. The driver delivered with the goods allows you to access the measuring device with existing,

non-network-compatible applications using a virtual COM port. **Compatible with KERN BalanceConnection software.** DIN track mount **3** or free-standing.

Scope of delivery: RS-232 Ethernet adapter with 1x Port RS-232 **1**, mains adapter **4**, CD (driver, software, operating instructions), adhesive feet.

Price interface cable incl.,
(please provide balance model in order),

KERN YKI-01, € 390,-



Note: To connect to your network, you will need information from your network administrator. We recommend discussing connecting your device into your network with the administrator before you place your order.



STANDARD



KERN YKI-03

RS-232 / WLAN adapter

High-quality adapter for the wireless connection of balances, force measuring devices etc. with RS-232 interface to WLAN-enabled devices, such as tablets, laptops, Smartphones etc. In this way, where there is a physical separation or a large distance between the devices, the weighing data from one or several balances can be easily transferred without cable to a WLAN device or a network (relevant software on the WLAN device needed, not included in delivery). The adapter allows direct integration of measurement devices into most company networks, with automatic configuration using DHCP or statistical IP allocation. You can access the current measuring data at any time from within the whole network, without having to use additional cables. The adapter supports a wide range of configurational options using the enclosed administration software or by the

web interface. The driver delivered with the goods allows you to access the measurement device with existing, non-network-compatible applications using a virtual COM port.

Compatible with KERN Balance Connection Software. The adapter also has an Ethernet interface for a wired connection to an IP-based Ethernet network **1**. Thanks to the screw terminals **2**, the power connection can be implemented individually using individual wires or using the robust, screw-in power connector **3**. Large input voltage range from 12 V – 8 V. Suitable for wall mounting and DIN track mount **4** or free-standing.

Scope of delivery: RS-232/WLAN adapter, mains adapter, network cable (1 m), driver CD.

Price interface cable incl.,
KERN YKI-03, € 780,-

KERN YKD-A02



Large display

with superior display size, digit height 3" (76 mm). Luminescent, red LED display for easy reading of weight, even from a distance or under poor lighting conditions. 6 segments, mains connection as standard (230 V, EU/GB), connection using RS-232 data interface, dimensions WxDxH 541x55x180 mm.

Suitable for series IFB, BFB, NFB, UFA, UFB,

KERN YKD-A02, € 215,-

KERN CFS-A03



Signal lamp

Signal lamp for visual support of weighing with tolerance range. Three-colour LED, red, green, yellow. Power supply via balance using RS-232. Total dimensions WxDxH 100x180x300 mm

Suitable for series BFB, BFN, CPB-N, GAB-N, GAB-P, IFB, KFB-TM, NBB, NFB, NFN, SFB, UFA, UFB, UFC, UFN,

KERN CFS-A03, € 250,-

KERN CFS-A04



2nd RS-232 data interface

separate Y cable, e.g. for simultaneous connection of a printer, signal lamp etc. Suitable for series BFB, CPB-N, CFS, GAB-N, GAB-P, IFB, KFB-TM, NFB, UFA, UFB, SFB, BAN, UFN, NFN

KERN CFS-A04, € 35,-

KERN AFH 12



RS-232/USB adapter

to connect peripheral devices with USB connection, fits on all balances and measuring instruments with RS-232 port.

Scope of delivery:
Converter cable, CD with driver,

KERN AFH 12, € 85,-

KERN AFH 14



2 x RS-232/USB adapter

to connect peripheral devices with USB connection, fits on all balances and measuring instruments with RS-232 port.

Scope of delivery:
Converter cable, CD with driver,

KERN AFH 14, € 65,-

KERN YKA-02



Power supply adapter set

from standard EU to GB/US/AUS/CH etc. Four pieces. Ideal for devices with Class II protection (not earthed). Ideal for Euro moulded plug,

KERN YKA-02, € 30,-

KERN YKP-01

Stand (tripodal)

stable and robust, to elevate display device, stainless steel, height-adjustable, height of stand approx. 750–1000 mm, Factory Option.

NEW

Suitable for series SFB (from weighing plate size WxD 500x400 mm), BFA, BBB, BFN, BBN, KEN-TM, UFN, NFN,

KERN YKP-01, € 360,-



KERN YKP-02

Stand (tripodal)

stable and robust, to elevate display device, stainless steel, height-adjustable, height of stand approx. 750–1000 mm, Factory Option.

NEW

Suitable for series SFE, IFS, IFB, BFB, BXS, BFS, BFA, BBB, BBN, UFA, UFB, UFC, NFB, NBB, KFE-TM, KXG-TM, KXS-TM, KEN-TM,

KERN YKP-02, € 210,-





KERN KXS-A03

Foot switch

Ideal, when 2 free hands are required for application. TARE or PRINT function can be selected. For the PRINT function you will need the RS-232 interface cable KERN KXS-A04.

Must be ordered at purchase, suitable for series BAN, BXS, IXS, SXS, KXS-TM, KXG-TM.

KERN KXS-A03, € 70,-



KERN RFS-A02

Tare pan

Made of stainless steel, which makes cleaning easy and hygienic. Ideal for weighing loose screws, small parts, fruit, vegetables, cheese, etc.

- WxDxH 370x240x20 mm
- Net weight approx. 524 g

KERN RFS-A02, € 55,-



KERN CH-A01N

Tare pan with pan beam

Made of stainless steel. Ideal for weighing loose small parts, fruit, vegetables etc. Max. load 30 kg. Removable tare pan which makes cleaning easy and hygienic. Suitable for models KERN CH 15K20, HCB 20K10, HCN 20K50IP, HDB-N.

- Dimensions: Tare pan Ø/H 273x40 mm
- Pan beam: WxDxH 320x273x300 mm
- Total dimensions: WxDxH 320x273x340 mm
- Total net weight approx. 1000 g

KERN CH-A01N, € 67,-



KERN RFB-A02

Sturdy transport case

for the safe transport and storage of series WTB-N, RFB, lockable. Inner dimensions WxDxH 330x290x117 mm, total dimensions WxDxH 510x360x220 mm,

(scale not included with delivery!)

KERN RFB-A02, € 95,-



KERN MPS-A07

Sturdy transport case

for the safe transport and storage of series EOE, EOB scales with weighing plate size ≤ 315x305mm without stand, inner dimensions WxDxH 425x315x65 mm, net weight approx. 2,2 kg,

(scale not included with delivery!)

KERN MPS-A07, € 115,-



KERN ABS-A08

Protective dust cover

For protection from dust and light. Suitable for all KERN analytical balances and precision balances with glass draught shield, except

KERN ADB, AET 100-5AM, AET 200-5DAM

KERN ABS-A08, € 30,-



KERN YDB-03

Universal density set

Universal density set for precise and convenient density determination of liquids and solids $\leq/\geq 1$. Suitable for all KERN analytical balances.

Scope of delivery: Beaker, thermometer, sample holder, adapter, equalising weights, volume plummet (stainless steel, 20 g), universal submersible basket for solid bodies which

float and sink. The wire of the submersible basket has a diameter of 0.5 mm and therefore complies with the requirements of DIN EN ISO 1183-1 (Test methods for the determination of density of non-foamed plastics),

KERN YDB-03, € 520,-



KERN 962-335V

Density determination of the volume plummet

The density of the enclosed steel volume plummet can be determined by using the universal density set to measure solids. We would be pleased to determine the density of the volume plummet for you quickly and at a reasonable price in our DAkkS calibration laboratory.

You will receive a calibration certificate with all data relating to the density and volume,

KERN 962-335V, € 143,-



KERN YBI-01

Ioniser to neutralise electrostatic charge

Weighing items which are non-conductive, such as plastic, china, glass, etc often carry electrostatic charge. The electromagnetic field which then occurs between the items and the balance can cause the weighing result to be distorted by up to a gramme.

With the mount, **1** conveniently next to the balance or you can manually direct it from all sides onto a particular weighing item **2**.

Therefore, when weighing in milligrammes or even smaller increments, we recommend neutralising the electrostatic charge with the KERN AC-Korona discharge ioniser.

- Neutralisation $\pm 20V$
- Discharge of ozone 0,04 ppm/h
- Dimensions WxDxH 97x53x31 mm, WxDxH 190x60x110 mm incl. mount
- Net weight approx. 0,11 kg approx. 0,55 kg incl. mount
- Mains connection 110-230V/50Hz, AC power supply, 12V DC output

KERN YBI-01, € 1350,-



STANDARD



KERN YPS-03

Weighing table

Accurate measuring results require stable working conditions! The KERN YPS-03 weighing table has been constructed to absorb vibrations and oscillations, which would otherwise distort the weighing result.

- Work table with steel profile frame and height-adjustable feet
- Total dimensions WxDxH 770x650x815 mm
- Dimensions granite plate WxD 270x410 mm
- Net weight approx. 55 kg (scale not included with delivery!)

The YPS-03 weighing table consists of:

- Polished granite plate (34 kg) as integrated working surface, positioned on absorbing rubber components

1 Dispatch complete on pallet. Please ask for dimensions, gross weight, shipping costs,

KERN YPS-03, € 900,-



KERN PET-A01/KERN KET-A04

Software for database management

for easy maintenance of item data at the PC, such as, e.g., creating item detail links, capturing or deleting item data, creating item text etc. Data of the following categories can be edited: customers, stocks, universal variables, labels, packaging, users, products. Data transfer to the balance using the interface cable

(included as standard in the delivery with the balance),

For series KERN AET, PET:
KERN PET-A01, **€ 300,-**
For series KERN ILT:
KERN KET-A04, **€ 300,-**

STANDARD



RS 232



PET-A05



PET-A09

KERN PET-A05/KERN PET-A09

Barcode scanner

ergonomically optimised hand-held version, for connection to an RS-232 interface. Particularly robust and durable. Scratchproof scan window made of hardened glass. Large working area: data collection is possible up to a distance of 43 cm, dimensions WxDxH 152x84x63 mm,

Scope of delivery: barcode scanner, interface cable, mount,

RS-232 version: KERN PET-A05, **€ 350,-**
USB version: KERN PET-A09, **€ 350,-**

STANDARD

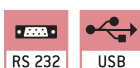

RS 232



USB



KERN PET-A13

Direct thermal label printer

very quiet and very quick, print speed of 150 mm/sec, maximum print width: 104 mm, maximum print length: 812 mm, internal power supply, interfaces: USB, RS-232. Especially suitable for the logistics industry, the pharmaceutical industry and in the retail sector. Dimensions WxDxH 231x289x186 mm.

Scope of delivery: Printer, USB interface cable, labeling software.

Suitable for series KERN KERN AET, BBB, BBN, CCP, CCT, ILT, KEN-TM, KET-TAM, PET,

KERN PET-A13, **€ 980,-**

Accessories

- Paper roll (1 pcs.), 1450 direct thermal labels, Dimensions labels WxD 100x50 mm, outer diameter label roll 120 mm, KERN PET-A12, **€ 65,-**

STANDARD

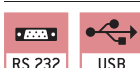

RS 232



USB



KERN PET-A14

Thermal transfer and direct thermal label printer

very quiet and very quick print speed of 101.6 mm/sec, maximum print width: 104 mm, maximum print length: 812 mm, internal power supply, interfaces: USB, RS-232. Especially suitable for the food, chemical and pharmaceutical industries. Software for easy editing of (adhesive) labels included with delivery. The sample labels can be sent to the balance as well as the printer. The sample labels can be sent to the balance as well as the printer. Dimensions WxDxH 231x289x270 mm.

Scope of delivery: Printer, USB interface cable, labeling software.

Suitable for series KERN AET, BBB, BBN, CCP, CCT, ILT, KEN-TM, KET-TAM, PET, KERN PET-A14, **€ 1000,-**

Accessories

- Paper roll (1 pcs.), 1500 direct thermal labels, dimensions labels WxD 100x50 mm, outer diameter label roll 120 mm, KERN PET-A10, **€ 80,-**
- Paper roll (1 pcs.), 1450 direct thermal labels, dimensions labels WxD 100x50 mm, outer diameter label roll 120 mm, KERN PET-A12, **€ 65,-**

NEW

KERN PET-A17

Cable with special length 3 m

between the display and the weighing unit, for verified models this cannot be ordered afterwards, suitable for series KERN AET, PET.

KERN PET-A17, € 250,-

KERN ILT-A03

Cable with special length 15 m

between display device and platform, for verified models this cannot be ordered afterwards, suitable for series KERN ILT.

KERN ILT-A03, € 250,-

KERN PET-A03/KERN KET-A03

Second display

Ideal for training and demonstration purposes in laboratories or industry. Large backlit LCD display with digit height 25 mm. KERN KET-A03: 6 segments, KERN PET-A03: 8 segments. 2 additional data interfaces RS-232. Interface cable to the balance, length approx. 1,5 m, as well as mains adapter standard.

Dimensions WxDxH 150x58x100 mm.

For series KERN AET, PET:
KERN PET-A03, € 210,-
For series KERN ILT:
KERN KET-A03, € 210,-

KERN KET-A06

Large display

with superior display size, digit height 4,4" (117.7 mm). Luminescent LCD display for easy reading of weight, even from a distance or under poor lighting conditions. Ready for wall mounting. 6 segments, mains connection as standard (230 V, EU / GB). Connection to the balance using the RS-232 or RS-485 interface. Stainless steel housing IP66 protection.

Dimensions WxDxH 541x55x180 mm. Suitable for series KERN BBB, BBN, ILT-GM, KET-TAM.

KERN KET-A06, € 1450,-

KERN KET-A10

Signal lamp

Signal lamp for visual support of weighing with tolerance range. Three-colour LED, red, green, yellow. Power supply via balance using RS-232. Total dimensions WxDxH 100x180x300 mm. Scope of delivery: Signal lamp CFS-A03, adapter cable KET-A11.

Suitable for series KERN ILT-BAM, ILT-GAM, KET-TAM.

KERN KET-A10, € 270,-

KERN PET-A06

USB keyboard

For easy capture of item data at the balance, for connection to a USB interface. 105 keys, separate numeric keypad, black housing, Dimensions WxDxH 440x128x24 mm.

Suitable for series KERN AET, PET, BBB, BBN, ILT, KET-TAM, KEN-TM.

KERN PET-A06, € 45,-

STANDARD

RS 232



STANDARD

RS 232 RS 485 IP 66



STANDARD

USB





KERN KET-A01

Analogue/Digital converter

to connect up to two platforms to the display device, suitable for series KERN BBB-N, BBN, ILT-BAM, ILT-GAM, KET-TAM,

KERN KET-A01, € 350,-

KERN KEN-A07

Relay output

with 4 outputs for weighing in 2 tolerance ranges, cannot be ordered afterwards, suitable for series KERN BBB, KEN-TM,

KERN KEN-A07, € 180,-

KERN KEN-A09

Profibus module

for integrating a KERN balance into a Profibus network, suitable for series KERN BBB, KEN-TM,

KERN KEN-A09, € 250,-

KERN KET-A02

Wall mount

to fit the display device (see Fig.), the display device can be fitted at two angles, dimensions WxDxH 135x148x110 mm, suitable for series KERN ILT-BM, ILT-GM, KET-TAM,

KERN KET-A02, € 190,-
(Display device is not included with the delivery)



KERN KEN-A06

Analogue module

for control and warning tasks etc. depending on a specific, defined weight, e.g. when dispensing. Output voltage 0-10V, suitable for series KERN BBB, KEN-TM,

KERN KEN-A06, € 350,-

KERN KEN-A08

Digital I/O interface (8 in/8 out)

e.g. to control machines, plant, relays, signal lamps, valves etc., suitable for series KERN BBB, KEN-TM,

KERN KEN-A08, € 600,-



KET-A05/KET-A08

Transponder card reader

RFID technology, dimensions WxDxH 133x30x98 mm, suitable for series KERN AET, BBB, BBN, CCP, CCT, ILT-BAM, ILT-GAM, ILT-NM, KET-TAM, KEN-TM, PET.

Scope of delivery: transponder card reader, interface cable for connecting to the digital I/O interface. Transponder cards are not included with the delivery.

KERN KET-A05, € 450,-

Transponder cards for transponder card reader KET-A05, pack of 10 pcs.,

KERN KET-A08, € 65,-



WE WEIGH ALMOST EVERYTHING ... AND THAT'S NOT ALL!

Microscopes and Refractometers

We offer you a complete, carefully-designed range of biological microscopes, stereo microscopes, metallurgical microscopes, polarisation microscopes as well as analogue and digital refractometers which are high-quality and highly-competitive in terms of price.

Comprehensive product details, high-quality materials, durability and ergonomic operation are all in line with the typical KERN "virtues" - quick delivery, large stocks, competent advice, comprehensive pre- and after sales service.



Your personal copy is ready and waiting for you - you can request it now, free of charge!



Request your personal copy!

Medical Scales

For years an established name in doctors' surgeries, nursing homes, rehabilitation clinics and hospitals.

Wherever reliable quality is important, look no further than the complete KERN range of medical scales, from baby scales, to personal scales, chair scales, obesity scales through to hand grip dynamometers.

SAUTER measuring technology

The SAUTER measuring technology range covers a large selection of force-measurement devices, measurement devices for coating thickness, material thickness, hardness measurement equipment (Shore, Leeb), calliper gauges, photometers, sound level meters and test benches.



Request your personal copy now, free of charge!



Weights yesterday and today

Weights have always been used to carry out weighing procedures. This original purpose has almost disappeared. Today, weights are used almost exclusively for adjusting and testing = calibration of electronic balances. We therefore call them "Test weights" as this is their purpose of use.

Adjustment or calibration?

→ **Adjusting** a balance means that you are intervening in the weighing system, to make sure that the display is set to show the correct nominal value. With → **calibration** on the other hand, there is no intervention, you are testing whether the display is correct and documenting any deviation.

Testing, the right way!

The internationally valid OIML norm R111-2004 classifies test weights hierarchically in accuracy classes, where E1 is the most accurate and M3 is the least accurate weight class. With KERN you get the whole test weight range in all OIML accuracy classes E1, E2, F1, F2, M1, M2, M3.

As the appropriate test weight is only classed as checking equipment according to → **ISO 9000ff** if it has the relevant proof of accuracy, all KERN test weights come with an appropriate → **DAkkS-calibration certificate**. For further details, see the calibration service section on page 208.

KERN offers you the appropriate test weight package for your balance, consisting of the test weight, box and DAkkS-calibration certificate, as proof of its accuracy. The best pre-requisite for proper balance calibration.

→ See the glossary on page 214 – 216

Test weights: classes of accuracy E, F, M and their general relation to the types of balances:

- E1 Test weights for customers who require a high degree of accuracy for the most demanding applications. For high-resolution balances with $d > 1,000,000$ Use recommended with DAkkS calibration certificate only.
- E2 Most accurate test weights for high resolution analytical balances of verification class I $\geq 100,000$ e
- F1 Test weights for analytical balances/precision balances for verification class I/II $\leq 100,000$ e
- F2 Test weights for precision balances of verification class II, $\leq 30,000$ e
- M1 Test weights for industrial and commercial scales of verification class III $\leq 10,000$ e



Marietta Diener

Product specialist Test weights

Tel. +49 [0] 7433 9933- 167

Fax +49 [0] 7433 9933-29167

diener@kern-sohn.com

Selection of the appropriate test weight for your balance

Correctly selected test weights with DAkkS calibration certificate are the pre-requisite for ensuring that your balances are not only correctly adjusted, but also correctly calibrated. Scheduled testing of your balances with such test weights helps to guarantee your quality requirements and to maintain your quality targets.

Here's how you find the right test weight for your balance:

A balance can never be more accurate than the test weight used to adjust it, it all depends on its tolerance.

Accuracy of the test weight: Should correspond to the readout [d] of the balance, or rather be better.

Nominal weight value: This is shown in adjust mode "CAL" in the balance display. Given a choice, the heaviest weight is the most suitable for accurate measurement.

Once accuracy and nominal weight value are specified, the suitable test weight is selected according to the tolerances "Tol" of the individual accuracy classes E2 - M3, see column "Tol ± mg" at the respective weight and table at page 190.

Example:

Balance with weighing range [Max] 2000 g = 2 kg and readout [d] = 0,01 g = 10 mg

- The accuracy of the required test weight is determined by readout [d] with approx. ± 10 mg.
- Displayed weight size on "CAL" mode: 1000 g or 2000 g. The required test weight has a 2 kg weight size.
- Suitable test weights with ± 10 mg tolerance and 2 kg weight size, can be found in accuracy class F1. KERN-No 327-72, see page 195.

Exception, analytical balances (readout [d] ≤ 0,1 mg):

E1 test weights are recommended. Depending on the safety requirements, E2 test weights with a DAkkS calibration certificate will also be sufficient.

From brass to stainless steel - the right test weight for every situation



Test weight	Cylindrical shape with lifting knob, polished stainless steel	Compact shape with carrying grip, polished stainless steel	Cylindrical shape with lifting knob, polished stainless steel or nickelplated and polished brass	Compact shape with carrying grip, finely turned stainless steel	Cylindrical shape with lifting knob, finely turned stainless steel	Cylindrical shape with lifting knob, finely turned brass
Features						
Conforms to OIML R111	yes	yes	yes	no	yes	yes
Available classes	E1, E2	E2, F1	F1	adjusted to F1 error limit class	F2, M1	M1, M2, M3
Upper surface	polished	polished	polished	finely turned	finely turned	finely turned
Material	Stainless steel	Stainless steel	Stainless steel or nickel-plated brass	Stainless steel	Stainless steel	Brass
Adjusting cavity	no	no	yes	yes, from 20 g	yes, from 20 g	yes, from 20 g
Verification possible	yes	yes	yes	nein	yes	yes, except M2
Checking equipment for verification purposes	approved	approved	approved	not approved	approved	approved (M1, M2)
Ideal as checking equipment in QM systems (e.g. ISO 9000 ff)	yes	yes	yes	yes	yes	yes
Benefits	<ul style="list-style-type: none"> • High-quality test weight for analytical and precision balances • Highly-refined surface • Ideal shape of the top for good grip 	<ul style="list-style-type: none"> • Affordable test weight for analytical and precision balances • Highly-refined surface 	<ul style="list-style-type: none"> • Ideal, high-quality test weight for precision balances • Ideal shape of the top for good grip 	<ul style="list-style-type: none"> • Affordable test weight for in-house checking of precision balances 	<ul style="list-style-type: none"> • Ideal test weight for commercial and industrial scales • Ideal shape of the top for good grip 	<ul style="list-style-type: none"> • Affordable test weight for commercial and industrial scales • Ideal shape of the top for good grip

OIML norm R111-2004 for weights

The key points from the OIML norm R111-2004

OIML (Organisation Internationale de Metrologie Legale) has established the exact metrological requirements for weights in verified applications in approx. 100 states all over the world. The OIML recommendation R111 (2004 Edition) for weights relates to sizes 1 mg – 5000 kg. Statements are made on the accuracy, materials, geometric shape, marking and storage of the weights.

Error limits for weights of classes E1 to M3

The error limit classes are in fixed hierarchical levels in the proportion of 1:3, where E1 is the most accurate and M3 is the least accurate weight class. When testing weights with other weights, the correct test class is the next highest class.

Error limit classes (= tolerances)

The values given in the table below (tolerances $\pm \dots$ mg) are the respective permitted fabrication tolerances. They are to be equal to the \rightarrow **measuring uncertainty** of the weight, if no \rightarrow **DAkkS calibration certificate** is available.

Conventional mass

The problem is the air buoyancy, which makes the weight appear lighter. In order to avoid this “distortion” in daily use, all weights are adjusted to the unit specifications as given in R111, e.g. it is accepted that: material density of the weights is 8000 kg/m³, air density is 1.2 kg/m³ and measuring temperature is 20 °C.

KERN cylindrical test weights

Comply with OIML R111-2004 in all respects, without exception.

\rightarrow See the glossary, page 214 – 216

Nominal value ↓	OIML R111-2004 Maximum permissible errors for weights = permissible tolerances “Tol \pm mg”						
	E1	E2	F1	F2	M1	M2	M3
1 mg	$\pm 0,003$ mg	$\pm 0,006$ mg	$\pm 0,020$ mg	$\pm 0,06$ mg	$\pm 0,20$ mg	-	-
2 mg	$\pm 0,003$ mg	$\pm 0,006$ mg	$\pm 0,020$ mg	$\pm 0,06$ mg	$\pm 0,20$ mg	-	-
5 mg	$\pm 0,003$ mg	$\pm 0,006$ mg	$\pm 0,020$ mg	$\pm 0,06$ mg	$\pm 0,20$ mg	-	-
10 mg	$\pm 0,003$ mg	$\pm 0,008$ mg	$\pm 0,025$ mg	$\pm 0,08$ mg	$\pm 0,25$ mg	-	-
20 mg	$\pm 0,003$ mg	$\pm 0,010$ mg	$\pm 0,03$ mg	$\pm 0,10$ mg	$\pm 0,3$ mg	-	-
50 mg	$\pm 0,004$ mg	$\pm 0,012$ mg	$\pm 0,04$ mg	$\pm 0,12$ mg	$\pm 0,4$ mg	-	-
100 mg	$\pm 0,005$ mg	$\pm 0,016$ mg	$\pm 0,05$ mg	$\pm 0,16$ mg	$\pm 0,5$ mg	$\pm 1,6$ mg	-
200 mg	$\pm 0,006$ mg	$\pm 0,020$ mg	$\pm 0,06$ mg	$\pm 0,20$ mg	$\pm 0,6$ mg	$\pm 2,0$ mg	-
500 mg	$\pm 0,008$ mg	$\pm 0,025$ mg	$\pm 0,08$ mg	$\pm 0,25$ mg	$\pm 0,8$ mg	$\pm 2,5$ mg	-
1 g	$\pm 0,010$ mg	$\pm 0,03$ mg	$\pm 0,10$ mg	$\pm 0,3$ mg	$\pm 1,0$ mg	$\pm 3,0$ mg	± 10 mg
2 g	$\pm 0,012$ mg	$\pm 0,04$ mg	$\pm 0,12$ mg	$\pm 0,4$ mg	$\pm 1,2$ mg	$\pm 4,0$ mg	± 12 mg
5 g	$\pm 0,016$ mg	$\pm 0,05$ mg	$\pm 0,16$ mg	$\pm 0,5$ mg	$\pm 1,6$ mg	$\pm 5,0$ mg	± 16 mg
10 g	$\pm 0,020$ mg	$\pm 0,06$ mg	$\pm 0,20$ mg	$\pm 0,6$ mg	$\pm 2,0$ mg	$\pm 6,0$ mg	± 20 mg
20 g	$\pm 0,025$ mg	$\pm 0,08$ mg	$\pm 0,25$ mg	$\pm 0,8$ mg	$\pm 2,5$ mg	$\pm 8,0$ mg	± 25 mg
50 g	$\pm 0,03$ mg	$\pm 0,10$ mg	$\pm 0,3$ mg	$\pm 1,0$ mg	$\pm 3,0$ mg	± 10 mg	± 30 mg
100 g	$\pm 0,05$ mg	$\pm 0,16$ mg	$\pm 0,5$ mg	$\pm 1,6$ mg	$\pm 5,0$ mg	± 16 mg	± 50 mg
200 g	$\pm 0,10$ mg	$\pm 0,3$ mg	$\pm 1,0$ mg	$\pm 3,0$ mg	± 10 mg	± 30 mg	± 100 mg
500 g	$\pm 0,25$ mg	$\pm 0,8$ mg	$\pm 2,5$ mg	$\pm 8,0$ mg	± 25 mg	± 80 mg	± 250 mg
1 kg	$\pm 0,5$ mg	$\pm 1,6$ mg	$\pm 5,0$ mg	± 16 mg	± 50 mg	± 160 mg	± 500 mg
2 kg	$\pm 1,0$ mg	$\pm 3,0$ mg	± 10 mg	± 30 mg	± 100 mg	± 300 mg	$\pm 1\,000$ mg
5 kg	$\pm 2,5$ mg	$\pm 8,0$ mg	± 25 mg	± 80 mg	± 250 mg	± 800 mg	$\pm 2\,500$ mg
10 kg	$\pm 5,0$ mg	± 16 mg	± 50 mg	± 160 mg	± 500 mg	$\pm 1\,600$ mg	$\pm 5\,000$ mg
20 kg	± 10 mg	± 30 mg	± 100 mg	± 300 mg	$\pm 1\,000$ mg	$\pm 3\,000$ mg	± 10 g
50 kg	± 25 mg	± 80 mg	± 250 mg	± 800 mg	$\pm 2\,500$ mg	$\pm 8\,000$ mg	± 25 g
100 kg	-	± 160 mg	± 500 mg	$\pm 1\,600$ mg	$\pm 5\,000$ mg	± 16 g	± 50 g
200 kg	-	± 300 mg	$\pm 1\,000$ mg	$\pm 3\,000$ mg	± 10 g	± 30 g	± 100 g
500 kg	-	± 800 mg	$\pm 2\,500$ mg	$\pm 8\,000$ mg	± 25 g	± 80 g	± 250 g
1 000 kg	-	$\pm 1\,600$ mg	$\pm 5\,000$ mg	± 16 g	± 50 g	± 160 g	± 500 g
2 000 kg	-	-	± 10 g	± 30 g	± 100 g	± 300 g	$\pm 1\,000$ g
5 000 kg	-	-	± 25 g	± 80 g	± 250 g	± 800 g	$\pm 2\,500$ g

Composition table, valid for all KERN weight sets from 1 mg

Individual weights per set \rightarrow	1	2	2	5	10	20	20	50	100	200	200	500	1	2	2	5	10	
Weight set \downarrow	mg	mg	mg	mg	mg	mg	mg	mg	mg	mg	mg	mg	g	g	g	g	g	
1 mg – 500 mg	Total weight												1,11 g					
1 mg – 50 g													111,11 g					
1 mg – 100 g													211,11 g					
1 mg – 200 g													611,11 g					
1 mg – 500 g													1.111,11 g					
1 mg – 1 kg													2.111,11 g					
1 mg – 2 kg													6.111,11 g					
1 mg – 5 kg													11.111,11 g					
1 mg – 10 kg													21.111,11 g					

Test weights class E1

Class E1 Milligram weights, wire shape, stainless steel

Test weight material: stainless steel
Box material: Wood



Milligram weight				+		Box		+		DAkkS certificate		=		Package price	
KERN		Tol ± mg	€	KERN	€	KERN	€	KERN	€	KERN	€	KERN	€	KERN	€
308-31	1 mg	0,003	52,-	338-090-200	14,-	962-251	52,-								118,-
308-32	2 mg	0,003	52,-	338-090-200	14,-	962-252	52,-								118,-
308-33	5 mg	0,003	52,-	338-090-200	14,-	962-253	52,-								118,-
308-34	10 mg	0,003	52,-	338-090-200	14,-	962-254	52,-								118,-
308-35	20 mg	0,003	52,-	338-090-200	14,-	962-255	52,-								118,-
308-36	50 mg	0,004	52,-	338-090-200	14,-	962-256	52,-								118,-
308-37	100 mg	0,005	52,-	338-090-200	14,-	962-257	52,-								118,-
308-38	200 mg	0,006	52,-	338-090-200	14,-	962-258	52,-								118,-
308-39	500 mg	0,008	52,-	338-090-200	14,-	962-259	52,-								118,-

Class E1 Individual weights, cylindrical shape, polished stainless steel

Test weight material: Polished stainless steel
Box material: Lined wood



For weights
≤ 500 g

For weights
≥ 1 kg

Individual weight				+		Box		+		DAkkS certificate Initial calibration		=		Package price		DAkkS certificate Recalibration	
KERN		Tol ± mg	€	KERN	€	KERN	€	KERN	€	€	€	KERN	€	KERN	€	KERN	€
307-01	1 g	0,010	83,-	317-010-100	28,-	963-231	193,-			304,-		962-231 R	52,-				
307-02	2 g	0,012	89,-	317-020-100	28,-	963-232	193,-			310,-		962-232 R	52,-				
307-03	5 g	0,016	96,-	317-030-100	28,-	963-233	193,-			317,-		962-233 R	52,-				
307-04	10 g	0,020	104,-	317-040-100	28,-	963-234	193,-			325,-		962-234 R	52,-				
307-05	20 g	0,025	113,-	317-050-100	28,-	963-235	193,-			334,-		962-235 R	52,-				
307-06	50 g	0,03	135,-	317-060-100	28,-	963-236	193,-			356,-		962-236 R	52,-				
307-07	100 g	0,05	162,-	317-070-100	28,-	963-237	193,-			383,-		962-237 R	52,-				
307-08	200 g	0,10	194,-	317-080-100	28,-	963-238	193,-			415,-		962-238 R	52,-				
307-09	500 g	0,25	280,-	317-090-100	31,-	963-239	193,-			504,-		962-239 R	52,-				
307-11	1 kg	0,5	425,-	317-110-100	35,-	963-241	193,-			653,-		962-241 R	52,-				
307-12	2 kg	1,0	630,-	317-120-100	44,-	963-242	465,-			1139,-		962-242 R	64,-				
307-13	5 kg	2,5	1060,-	317-130-100	66,-	963-243	465,-			1591,-		962-243 R	64,-				
307-14	10 kg	5,0	1530,-	317-140-100	89,-	963-244	465,-			2084,-		962-244 R	64,-				
307-15	20 kg	10,0	2160,-	317-150-100	340,-	963-245	1160,-			3660,-		962-245 R	590,-				
307-16	50 kg	25,0	4140,-	317-160-100	415,-	963-246	1360,-			5915,-		962-246 R	660,-				

For E1 weights > 1g at the point of initial calibration, a volume determination will be carried out in accordance with OIML R111. When recalibrating, this is not required.

Class E1 Weight sets, cylindrical shape, polished stainless steel

Test weight material: Polished stainless steel
Case material: Lined wood. Milligram weights 1 mg - 500 mg in plastic box.



Weight set			+		DAkkS certificate Initial calibration		=		Package price		DAkkS certificate Recalibration	
KERN		€	KERN	€	KERN	€	KERN	€	KERN	€	KERN	€
308-42	1 mg - 500 mg	655,-	962-250	350,-					1005,-		962-250 R	350,-
303-02	1 mg - 50 g	1540,-	963-201	1070,-					2610,-		962-201 R	560,-
303-03	1 mg - 100 g	1700,-	963-202	1170,-					2870,-		962-202 R	580,-
303-04	1 mg - 200 g	2090,-	963-203	1350,-					3440,-		962-203 R	630,-
303-05	1 mg - 500 g	2420,-	963-204	1440,-					3860,-		962-204 R	660,-
303-06	1 mg - 1 kg	2840,-	963-205	1530,-					4370,-		962-205 R	700,-
303-07	1 mg - 2 kg	4150,-	963-206	2000,-					6150,-		962-206 R	750,-
303-08	1 mg - 5 kg	5300,-	963-207	2450,-					7750,-		962-207 R	770,-
303-09	1 mg - 10 kg	6890,-	963-208	2900,-					9790,-		962-208 R	800,-
304-02	1 g - 50 g	910,-	963-215	770,-					1680,-		962-215 R	245,-
304-03	1 g - 100 g	1070,-	963-216	860,-					1930,-		962-216 R	270,-
304-04	1 g - 200 g	1460,-	963-217	1040,-					2500,-		962-217 R	320,-
304-05	1 g - 500 g	1790,-	963-218	1130,-					2920,-		962-218 R	350,-
304-06	1 g - 1 kg	2210,-	963-219	1230,-					3440,-		962-219 R	375,-
304-07	1 g - 2 kg	3520,-	963-220	1780,-					5300,-		962-220 R	425,-
304-08	1 g - 5 kg	4670,-	963-221	2230,-					6900,-		962-221 R	450,-
304-09	1 g - 10 kg	6260,-	963-222	2690,-					8950,-		962-222 R	485,-

Test weights class E2

Class E2 Milligram weights, flat polygonal sheet, aluminium/German silver

Test weight material: Aluminium 1 mg – 5 mg/German silver 10 mg – 500 mg
 Container material: Lined plastic



Milligram weight				+		Container		+		DAkkS certificate		=		Package price	
KERN		Tol ± mg	€	KERN	€	KERN	€	KERN	€	KERN	€	KERN	€	KERN	€
318-01	1 mg	0,006	24,-	347-009-400	2,-	962-351	26,-								
318-02	2 mg	0,006	24,-	347-009-400	2,-	962-352	26,-								
318-03	5 mg	0,006	24,-	347-009-400	2,-	962-353	26,-								
318-04	10 mg	0,008	24,-	347-009-400	2,-	962-354	26,-								
318-05	20 mg	0,010	24,-	347-009-400	2,-	962-355	26,-								
318-06	50 mg	0,012	24,-	347-009-400	2,-	962-356	26,-								
318-07	100 mg	0,016	24,-	347-009-400	2,-	962-357	26,-								
318-08	200 mg	0,020	24,-	347-009-400	2,-	962-358	26,-								
318-09	500 mg	0,025	24,-	347-009-400	2,-	962-359	26,-								

Class E2 Individual weights, compact shape, polished stainless steel

Test weight material: Polished stainless steel
 Container material: Lined plastic



Individual weight				+		Container		+		DAkkS certificate		=		Package price	
KERN		Tol ± mg	€	KERN	€	KERN	€	KERN	€	KERN	€	KERN	€	KERN	€
316-01	1 g	0,03	33,-	317-020-400	6,-	962-331	26,-								
316-02	2 g	0,04	35,-	317-020-400	6,-	962-332	26,-								
316-03	5 g	0,05	37,-	317-030-400	6,-	962-333	26,-								
316-04	10 g	0,06	39,-	317-040-400	6,-	962-334	26,-								
316-05	20 g	0,08	45,-	317-050-400	6,-	962-335	26,-								
316-06	50 g	0,10	48,-	317-060-400	6,-	962-336	26,-								
316-07	100 g	0,16	52,-	317-070-400	6,-	962-337	33,-								
316-08	200 g	0,3	66,-	317-080-400	6,-	962-338	33,-								
316-09	500 g	0,8	111,-	317-090-400	9,-	962-339	33,-								
316-11	1 kg	1,6	161,-	317-110-400	9,-	962-341	33,-								
316-12	2 kg	3,0	260,-	317-120-400	9,-	962-342	41,-								
316-13	5 kg	8,0	375,-	317-130-400	15,-	962-343	41,-								
316-14	10 kg	16,0	530,-	317-140-400	20,-	962-344	41,-								

Class E2 Individual weights, cylindrical shape, polished stainless steel

Test weight material: Polished stainless steel
 Container material: Lined plastic or wooden box (317-150-100 and 317-160-100)



Individual weight				+		Container		+		DAkkS certificate		=		Package price	
KERN		Tol ± mg	€	KERN	€	KERN	€	KERN	€	KERN	€	KERN	€	KERN	€
317-01	1 g	0,03	47,-	317-020-400	6,-	962-331	26,-								
317-02	2 g	0,04	50,-	317-020-400	6,-	962-332	26,-								
317-03	5 g	0,05	54,-	317-030-400	6,-	962-333	26,-								
317-04	10 g	0,06	56,-	317-040-400	6,-	962-334	26,-								
317-05	20 g	0,08	65,-	317-050-400	6,-	962-335	26,-								
317-06	50 g	0,10	76,-	317-060-400	6,-	962-336	26,-								
317-07	100 g	0,16	82,-	317-070-400	6,-	962-337	33,-								
317-08	200 g	0,3	104,-	317-080-400	6,-	962-338	33,-								
317-09	500 g	0,8	175,-	317-090-400	9,-	962-339	33,-								
317-11	1 kg	1,6	260,-	317-110-400	9,-	962-341	33,-								
317-12	2 kg	3,0	415,-	317-120-400	9,-	962-342	41,-								
317-13	5 kg	8,0	590,-	317-130-400	15,-	962-343	41,-								
317-14	10 kg	16,0	850,-	317-140-400	20,-	962-344	41,-								
317-15	20 kg	30,0	1340,-	317-150-100	340,-	962-345	52,-								
317-16	50 kg	80,0	2780,-	317-160-100	415,-	962-346	64,-								

For individual weights, wooden boxes are also available as an alternative to the plastic containers.
 For more details on this, please see page 206.

For weights
 ≤ 500 g

For weights
 ≥ 1 kg

Test weights class E2

Class E2 Weight sets, compact shape, polished stainless steel

Test weight material: Polished stainless steel
Case material: Lined plastic



Weight set			+ DAKkS certificate		= Package price	
KERN		€	KERN	€	KERN	€
312-024	1 g - 50 g	370,-	962-315	127,-		497,-
312-034	1 g - 100 g	410,-	962-316	150,-		560,-
312-044	1 g - 200 g	500,-	962-317	196,-		696,-
312-054	1 g - 500 g	610,-	962-318	220,-		830,-
312-064	1 g - 1 kg	810,-	962-319	245,-		1055,-
312-074	1 g - 2 kg	1310,-	962-320	305,-		1615,-
312-084	1 g - 5 kg	1650,-	962-321	340,-		1990,-

Class E2 Weight sets, cylindrical shape, polished stainless steel

Test weight material: Individual weights, polished stainless steel, milligram weights aluminium/German silver
Case material: Lined plastic. Milligram weights 1 mg - 500 mg in plastic box



Weight set			+ DAKkS certificate		= Package price	
KERN		€	KERN	€	KERN	€
318-22	1 mg - 500 mg	320,-	962-350	190,-		510,-
313-024	1 mg - 50 g	820,-	962-301	315,-		1135,-
313-034	1 mg - 100 g	910,-	962-302	340,-		1250,-
313-044	1 mg - 200 g	1110,-	962-303	385,-		1495,-
313-054	1 mg - 500 g	1270,-	962-304	410,-		1680,-
313-064	1 mg - 1 kg	1630,-	962-305	435,-		2065,-
313-074	1 mg - 2 kg	2460,-	962-306	495,-		2955,-
313-084	1 mg - 5 kg	3050,-	962-307	530,-		3580,-
314-024	1 g - 50 g	540,-	962-315	127,-		667,-
314-034	1 g - 100 g	620,-	962-316	150,-		770,-
314-044	1 g - 200 g	830,-	962-317	196,-		1026,-
314-054	1 g - 500 g	1010,-	962-318	220,-		1230,-
314-064	1 g - 1 kg	1340,-	962-319	245,-		1585,-
314-074	1 g - 2 kg	2180,-	962-320	305,-		2485,-
314-084	1 g - 5 kg	2760,-	962-321	340,-		3100,-

Class E2 Weight sets, cylindrical shape, polished stainless steel

Test weight material: Individual weights, polished stainless steel, milligram weights aluminium /German silver
Case material: Lined wood. Milligram weights 1 mg - 500 mg in plastic box.



Weight set			+ DAKkS certificate		= Package price	
KERN		€	KERN	€	KERN	€
318-22	1 mg - 500 mg	320,-	962-350	190,-		510,-
313-02	1 mg - 50 g	880,-	962-301	315,-		1195,-
313-03	1 mg - 100 g	960,-	962-302	340,-		1300,-
313-04	1 mg - 200 g	1170,-	962-303	385,-		1555,-
313-05	1 mg - 500 g	1400,-	962-304	410,-		1810,-
313-06	1 mg - 1 kg	1670,-	962-305	435,-		2105,-
313-07	1 mg - 2 kg	2550,-	962-306	495,-		3045,-
313-08	1 mg - 5 kg	3250,-	962-307	530,-		3780,-
313-09	1 mg - 10 kg	4180,-	962-308	560,-		4740,-
314-02	1 g - 50 g	590,-	962-315	127,-		717,-
314-03	1 g - 100 g	670,-	962-316	150,-		820,-
314-04	1 g - 200 g	880,-	962-317	196,-		1076,-
314-05	1 g - 500 g	1120,-	962-318	220,-		1340,-
314-06	1 g - 1 kg	1380,-	962-319	245,-		1625,-
314-07	1 g - 2 kg	2260,-	962-320	305,-		2565,-
314-08	1 g - 5 kg	2960,-	962-321	340,-		3300,-
314-09	1 g - 10 kg	3890,-	962-322	370,-		4260,-

Test weights class F1

Class F1 Milligram weights, flat polygonal sheet, aluminium/German silver

Test weight material: Aluminium 1 mg – 5 mg/German silver 10 mg – 500 mg
 Container material: Lined plastic



Milligram weight				+	Container		+	DAkkS certificate		=	Package price	
KERN		Tol ± mg	€		KERN	€		KERN	€		KERN	€
328-01	1 mg	0,020	11,-		347-009-400	2,-		962-451	18,-			31,-
328-02	2 mg	0,020	11,-		347-009-400	2,-		962-452	18,-			31,-
328-03	5 mg	0,020	11,-		347-009-400	2,-		962-453	18,-			31,-
328-04	10 mg	0,025	11,-		347-009-400	2,-		962-454	18,-			31,-
328-05	20 mg	0,03	11,-		347-009-400	2,-		962-455	18,-			31,-
328-06	50 mg	0,04	11,-		347-009-400	2,-		962-456	18,-			31,-
328-07	100 mg	0,05	11,-		347-009-400	2,-		962-457	18,-			31,-
328-08	200 mg	0,06	11,-		347-009-400	2,-		962-458	18,-			31,-
328-09	500 mg	0,08	11,-		347-009-400	2,-		962-459	18,-			31,-

Individual weights, compact shape, finely turned stainless steel

Test weight material: finely turned stainless steel
 Container material: Lined plastic

■ Build type: Not in accordance with OIML R111, adjusted to error limit class F1



Individual weight				+	Container		+	DAkkS certificate		=	Package price	
KERN		Tol ± mg	€		KERN	€		KERN	€		KERN	€
329-01	1 g	0,10	18,-		347-030-400	2,-		962-431N	18,-			38,-
329-02	2 g	0,12	19,-		347-030-400	2,-		962-432N	18,-			39,-
329-03	5 g	0,16	20,-		347-030-400	2,-		962-433N	18,-			40,-
329-04	10 g	0,20	23,-		347-050-400	2,-		962-434N	18,-			43,-
329-05	20 g	0,25	25,-		347-050-400	2,-		962-435N	18,-			45,-
329-06	50 g	0,3	27,-		347-070-400	2,-		962-436N	18,-			47,-
329-07	100 g	0,5	31,-		347-070-400	2,-		962-437N	20,-			53,-
329-08	200 g	1,0	41,-		347-080-400	2,-		962-438N	20,-			63,-
329-09	500 g	2,5	58,-		347-090-400	3,-		962-439N	20,-			81,-
329-11	1 kg	5,0	83,-		347-110-400	3,-		962-441N	20,-			106,-
329-12	2 kg	10	127,-		347-120-400	3,-		962-442N	25,-			155,-
329-13	5 kg	25	218,-		347-130-400	9,-		962-443N	25,-			252,-
329-14	10 kg	50	412,-		347-140-400	9,-		962-444N	25,-			446,-

Class F1 Individual weights, compact shape, polished stainless steel

Test weight material: Polished stainless steel
 Container material: Lined plastic



Individual weight				+	Container		+	DAkkS certificate		=	Package price	
KERN		Tol ± mg	€		KERN	€		KERN	€		KERN	€
326-01	1 g	0,10	22,-		347-030-400	2,-		962-431	18,-			42,-
326-02	2 g	0,12	23,-		347-030-400	2,-		962-432	18,-			43,-
326-03	5 g	0,16	25,-		347-030-400	2,-		962-433	18,-			45,-
326-04	10 g	0,20	28,-		347-050-400	2,-		962-434	18,-			48,-
326-05	20 g	0,25	29,-		347-050-400	2,-		962-435	18,-			49,-
326-06	50 g	0,3	32,-		347-070-400	2,-		962-436	18,-			52,-
326-07	100 g	0,5	36,-		347-070-400	2,-		962-437	20,-			58,-
326-08	200 g	1,0	49,-		347-080-400	2,-		962-438	20,-			71,-
326-09	500 g	2,5	68,-		347-090-400	3,-		962-439	20,-			91,-
326-11	1 kg	5,0	101,-		347-110-400	3,-		962-441	20,-			124,-
326-12	2 kg	10	150,-		347-120-400	3,-		962-442	25,-			178,-
326-13	5 kg	25	257,-		347-130-400	9,-		962-443	25,-			293,-
326-14	10 kg	50	485,-		347-140-400	9,-		962-444	25,-			519,-

Test weights class F1

Class F1 Individual weights, cylindrical shape, nickel-plated and polished brass

Test weight material: Nickel-plated and polished brass

Container material: Lined plastic or lined wooden box (317-150-100 and 317-160-100)



Individual weight				+	Container		+	DAkkS certificate		=	Package price	
KERN		Tol ± mg	€		KERN	€		KERN	€		KERN	€
327-61	1 g	0,10	23,-		347-030-400	2,-		962-431	18,-			43,-
327-62	2 g	0,12	24,-		347-030-400	2,-		962-432	18,-			44,-
327-63	5 g	0,16	26,-		347-030-400	2,-		962-433	18,-			46,-
327-64	10 g	0,20	29,-		347-050-400	2,-		962-434	18,-			49,-
327-65	20 g	0,25	31,-		347-050-400	2,-		962-435	18,-			51,-
327-66	50 g	0,3	34,-		347-070-400	2,-		962-436	18,-			54,-
327-67	100 g	0,5	38,-		347-070-400	2,-		962-437	20,-			60,-
327-68	200 g	1,0	52,-		347-080-400	2,-		962-438	20,-			74,-
327-69	500 g	2,5	72,-		347-090-400	3,-		962-439	20,-			95,-
327-71	1 kg	5,0	106,-		347-110-400	3,-		962-441	20,-			129,-
327-72	2 kg	10	158,-		347-120-400	3,-		962-442	25,-			186,-
327-73	5 kg	25	270,-		347-130-400	9,-		962-443	25,-			304,-
327-74	10 kg	50	510,-		347-140-400	9,-		962-444	25,-			544,-
327-75	20 kg	100	960,-		317-150-100	340,-		962-445	28,-			1328,-
327-76	50 kg	250	1800,-		317-160-100	415,-		962-446	39,-			2254,-

Class F1 Individual weights, cylindrical shape, polished stainless steel

Test weight material: Polished stainless steel

Container material: Lined plastic or lined wooden box (317-150-100 and 317-160-100)



Individual weight				+	Container		+	DAkkS certificate		=	Package price	
KERN		Tol ± mg	€		KERN	€		KERN	€		KERN	€
327-01	1 g	0,10	30,-		347-030-400	2,-		962-431	18,-			50,-
327-02	2 g	0,12	31,-		347-030-400	2,-		962-432	18,-			51,-
327-03	5 g	0,16	33,-		347-030-400	2,-		962-433	18,-			53,-
327-04	10 g	0,20	37,-		347-050-400	2,-		962-434	18,-			57,-
327-05	20 g	0,25	41,-		347-050-400	2,-		962-435	18,-			61,-
327-06	50 g	0,3	45,-		347-070-400	2,-		962-436	18,-			65,-
327-07	100 g	0,5	55,-		347-070-400	2,-		962-437	20,-			77,-
327-08	200 g	1,0	72,-		347-080-400	2,-		962-438	20,-			94,-
327-09	500 g	2,5	118,-		347-090-400	3,-		962-439	20,-			141,-
327-11	1 kg	5,0	165,-		347-110-400	3,-		962-441	20,-			188,-
327-12	2 kg	10	250,-		347-120-400	3,-		962-442	25,-			278,-
327-13	5 kg	25	375,-		347-130-400	9,-		962-443	25,-			409,-
327-14	10 kg	50	680,-		347-140-400	9,-		962-444	25,-			714,-
327-15	20 kg	100	1050,-		317-150-100	340,-		962-445	28,-			1418,-
327-16	50 kg	250	2270,-		317-160-100	415,-		962-446	39,-			2724,-



Alternative to plastic container:

Wooden boxes for individual weights. For more details on this, please see page 206.

Test weights class F1

Weight sets, compact shape, finely turned stainless steel



Check weight material: finely turned stainless steel, Case material: Lined plastic

■ **Build type: Not in accordance with OIML R111, adjusted to error limit class F1**

Weight set			+ DAKkS certificate		= Package price	
KERN		€	KERN	€	KERN	€
321-024	1 g - 50 g	185,-	962-415	67,-		252,-
321-034	1 g - 100 g	215,-	962-416	77,-		292,-
321-044	1 g - 200 g	280,-	962-417	98,-		378,-
321-054	1 g - 500 g	320,-	962-418	109,-		429,-
321-064	1 g - 1 kg	460,-	962-419	119,-		579,-
321-074	1 g - 2 kg	640,-	962-420	151,-		791,-
321-084	1 g - 5 kg	820,-	962-421	166,-		986,-

Class F1 Weight sets, compact shape, polished stainless steel



Test weight material: Polished stainless steel

Case material: Lined plastic

Weight set			+ DAKkS certificate		= Package price	
KERN		€	KERN	€	KERN	€
322-024	1 g - 50 g	235,-	962-415	67,-		302,-
322-034	1 g - 100 g	270,-	962-416	77,-		347,-
322-044	1 g - 200 g	350,-	962-417	98,-		448,-
322-054	1 g - 500 g	410,-	962-418	109,-		519,-
322-064	1 g - 1 kg	580,-	962-419	119,-		699,-
322-074	1 g - 2 kg	810,-	962-420	151,-		961,-
322-084	1 g - 5 kg	1030,-	962-421	166,-		1196,-

Class F1 Weight sets, cylindrical shape, polished and nickel-plated brass or polished stainless steel

Test weight material: Individual weights - nickel-plated and polished brass or polished stainless steel, milligram weights - aluminium 1 mg - 5 mg / German silver 10 mg - 500 mg

Case material: Lined plastic. Milligram weights 1 mg - 500 mg in plastic box.



Weight set			+ DAKkS certificate		= Package price	
KERN		€	KERN	€	KERN	€
328-22	1 mg - 500 mg	175,-	962-450	100,-		275,-
Nickel-plated and polished brass						
323-624	1 mg - 50 g	400,-	962-401	167,-		567,-
323-634	1 mg - 100 g	435,-	962-402	178,-		613,-
323-644	1 mg - 200 g	530,-	962-403	199,-		729,-
323-654	1 mg - 500 g	590,-	962-404	210,-		800,-
323-664	1 mg - 1 kg	750,-	962-405	220,-		970,-
323-674	1 mg - 2 kg	1030,-	962-406	250,-		1280,-
323-684	1 mg - 5 kg	1270,-	962-407	265,-		1535,-
324-624	1 g - 50 g	260,-	962-415	67,-		327,-
324-634	1 g - 100 g	300,-	962-416	77,-		377,-
324-644	1 g - 200 g	380,-	962-417	98,-		478,-
324-654	1 g - 500 g	450,-	962-418	109,-		559,-
324-664	1 g - 1 kg	630,-	962-419	119,-		749,-
324-674	1 g - 2 kg	900,-	962-420	151,-		1051,-
324-684	1 g - 5 kg	1140,-	962-421	166,-		1306,-
Polished stainless steel						
323-024	1 mg - 50 g	500,-	962-401	167,-		667,-
323-034	1 mg - 100 g	560,-	962-402	178,-		738,-
323-044	1 mg - 200 g	700,-	962-403	199,-		899,-
323-054	1 mg - 500 g	820,-	962-404	210,-		1030,-
323-064	1 mg - 1 kg	1070,-	962-405	220,-		1290,-
323-074	1 mg - 2 kg	1570,-	962-406	250,-		1820,-
323-084	1 mg - 5 kg	1920,-	962-407	265,-		2185,-
324-024	1 g - 50 g	340,-	962-415	67,-		407,-
324-034	1 g - 100 g	400,-	962-416	77,-		477,-
324-044	1 g - 200 g	540,-	962-417	98,-		638,-
324-054	1 g - 500 g	660,-	962-418	109,-		769,-
324-064	1 g - 1 kg	890,-	962-419	119,-		1009,-
324-074	1 g - 2 kg	1400,-	962-420	151,-		1551,-
324-084	1 g - 5 kg	1750,-	962-421	166,-		1916,-

Test weights class F1

Class F1 Weight sets, cylindrical shape, nickel-plated and polished brass or polished stainless steel

Test weight material: Individual weights polished or nickel-plated brass or polished stainless steel, milligram weights aluminium 1 mg – 5 mg/German silver 10 mg – 500 mg
Case material: Lined wood. Milligram weights 1 mg – 500 mg in plastic box.



Weight set			+ DAKkS certificate		= Package price	
KERN			KERN	€	KERN	€
328-22	1 mg - 500 mg	175,-	962-450	100,-		275,-
Polished and nickel-plated brass						
323-62	1 mg - 50 g	455,-	962-401	167,-		622,-
323-63	1 mg - 100 g	485,-	962-402	178,-		663,-
323-64	1 mg - 200 g	580,-	962-403	199,-		779,-
323-65	1 mg - 500 g	700,-	962-404	210,-		910,-
323-66	1 mg - 1 kg	790,-	962-405	220,-		1010,-
323-67	1 mg - 2 kg	1120,-	962-406	250,-		1370,-
323-68	1 mg - 5 kg	1470,-	962-407	265,-		1735,-
323-69	1 mg - 10 kg	1990,-	962-408	285,-		2275,-
324-62	1 g - 50 g	310,-	962-415	67,-		377,-
324-63	1 g - 100 g	350,-	962-416	77,-		427,-
324-64	1 g - 200 g	435,-	962-417	98,-		533,-
324-65	1 g - 500 g	560,-	962-418	109,-		669,-
324-66	1 g - 1 kg	660,-	962-419	119,-		779,-
324-67	1 g - 2 kg	980,-	962-420	151,-		1131,-
324-68	1 g - 5 kg	1330,-	962-421	166,-		1496,-
324-69	1 g - 10 kg	1850,-	962-422	182,-		2032,-
Polished stainless steel						
323-02	1 mg - 50 g	560,-	962-401	167,-		727,-
323-03	1 mg - 100 g	610,-	962-402	178,-		788,-
323-04	1 mg - 200 g	750,-	962-403	199,-		949,-
323-05	1 mg - 500 g	930,-	962-404	210,-		1140,-
323-06	1 mg - 1 kg	1100,-	962-405	220,-		1320,-
323-07	1 mg - 2 kg	1650,-	962-406	250,-		1900,-
323-08	1 mg - 5 kg	2110,-	962-407	265,-		2375,-
323-09	1 mg - 10 kg	2880,-	962-408	285,-		3165,-
324-02	1 g - 50 g	390,-	962-415	67,-		457,-
324-03	1 g - 100 g	450,-	962-416	77,-		527,-
324-04	1 g - 200 g	600,-	962-417	98,-		698,-
324-05	1 g - 500 g	760,-	962-418	109,-		869,-
324-06	1 g - 1 kg	940,-	962-419	119,-		1059,-
324-07	1 g - 2 kg	1480,-	962-420	151,-		1631,-
324-08	1 g - 5 kg	1950,-	962-421	166,-		2116,-
324-09	1 g - 10 kg	2710,-	962-422	182,-		2892,-



You can create your own individual weight set yourself:

It contains only the weights which you need for testing purposes. KERN will customise your own personal box out of plastic, wood or aluminium. For more details on this, please see page 207.



Test weights class F2

Class F2 Milligram weights, flat polygonal sheet, aluminium/German silver

Test weight material: Aluminium 1 mg – 5 mg/German silver 10 mg – 500 mg
Container material: Lined plastic



Milligram weight				+	Container		+	DAkkS certificate		=	Package price	
KERN		Tol ± mg	€		KERN	€		KERN	€		KERN	€
338-01	1 mg	0,06	10,-		347-009-400	2,-		962-451	18,-			31,-
338-02	2 mg	0,06	10,-		347-009-400	2,-		962-452	18,-			31,-
338-03	5 mg	0,06	10,-		347-009-400	2,-		962-453	18,-			31,-
338-04	10 mg	0,08	10,-		347-009-400	2,-		962-454	18,-			31,-
338-05	20 mg	0,10	10,-		347-009-400	2,-		962-455	18,-			31,-
338-06	50 mg	0,12	10,-		347-009-400	2,-		962-456	18,-			31,-
338-07	100 mg	0,16	10,-		347-009-400	2,-		962-457	18,-			31,-
338-08	200 mg	0,20	10,-		347-009-400	2,-		962-458	18,-			31,-
338-09	500 mg	0,25	10,-		347-009-400	2,-		962-459	18,-			31,-

Class F2 Individual weights, cylindrical shape, finely turned stainless steel

Test weight material: finely turned stainless steel
Container material: Lined plastic or wooden box (337-150-200 and 337-160-200)



Individual weight				+	Container		+	DAkkS certificate		=	Package price	
KERN		Tol ± mg	€		KERN	€		KERN	€		KERN	€
337-01	1 g	0,3	19,-		347-030-400	2,-		962-431	18,-			39,-
337-02	2 g	0,4	20,-		347-030-400	2,-		962-432	18,-			40,-
337-03	5 g	0,5	22,-		347-030-400	2,-		962-433	18,-			42,-
337-04	10 g	0,6	24,-		347-050-400	2,-		962-434	18,-			44,-
337-05	20 g	0,8	26,-		347-050-400	2,-		962-435	18,-			46,-
337-06	50 g	1,0	28,-		347-070-400	2,-		962-436	18,-			48,-
337-07	100 g	1,6	32,-		347-070-400	2,-		962-437	20,-			54,-
337-08	200 g	3,0	42,-		347-080-400	2,-		962-438	20,-			64,-
337-09	500 g	8,0	60,-		347-090-400	3,-		962-439	20,-			83,-
337-11	1 kg	16	84,-		347-110-400	3,-		962-441	20,-			107,-
337-12	2 kg	30	129,-		347-120-400	3,-		962-442	25,-			157,-
337-13	5 kg	80	220,-		347-130-400	9,-		962-443	25,-			254,-
337-14	10 kg	160	415,-		347-140-400	9,-		962-444	25,-			449,-
337-15	20 kg	300	710,-		337-150-200	220,-		962-445	28,-			958,-
337-16	50 kg	800	1290,-		337-160-200	345,-		962-446	39,-			1674,-



Alternative to plastic container:

Wooden boxes for individual weights. For more details on this, please see page 206.

Class F2 Test weights, stainless steel, stackable

Test weight material: finely turned stainless steel
Box material: Wood



Test weight				+	Container		+	DAkkS certificate		=	Package price	
KERN		Tol ± mg	Dim. Ø x H	€	KERN	€		KERN	€		KERN	€
337-141	10 kg	160	137x132 mm	550,-	337-141-200	190,-		962-444	25,-			765,-
337-151	20 kg	300	137x217 mm	670,-	337-151-200	235,-		962-445	28,-			933,-
337-161	50 kg	800	198x250 mm	1790,-	337-161-200	345,-		962-446	39,-			2174,-

Test weights class F2

Class F2 Weight sets, cylindrical shape, finely turned stainless steel

Test weight material: Individual weights - finely turned stainless steel,
milligram weights - aluminium 1 mg - 5 mg/German silver 10 mg - 500 mg
Case material: Lined plastic. Milligram weights 1 mg - 500 mg in plastic box.



Weight set			+ DAkkS certificate		= Package price	
KERN		€	KERN	€	KERN	€
338-22	1 mg - 500 mg	143,-	962-450	100,-		243,-
333-024	1 mg - 50 g	365,-	962-401	167,-		532,-
333-034	1 mg - 100 g	405,-	962-402	178,-		583,-
333-044	1 mg - 200 g	495,-	962-403	199,-		694,-
333-054	1 mg - 500 g	570,-	962-404	210,-		780,-
333-064	1 mg - 1 kg	690,-	962-405	220,-		910,-
333-074	1 mg - 2 kg	970,-	962-406	250,-		1220,-
333-084	1 mg - 5 kg	1250,-	962-407	265,-		1515,-
334-024	1 g - 50 g	225,-	962-415	67,-		292,-
334-034	1 g - 100 g	265,-	962-416	77,-		342,-
334-044	1 g - 200 g	360,-	962-417	98,-		458,-
334-054	1 g - 500 g	425,-	962-418	109,-		534,-
334-064	1 g - 1 kg	560,-	962-419	119,-		679,-
334-074	1 g - 2 kg	850,-	962-420	151,-		1001,-
334-084	1 g - 5 kg	1120,-	962-421	166,-		1286,-

Class F2 Weight sets, cylindrical shape, finely turned stainless steel

Test weight material: Individual weights - finely turned stainless steel,
milligram weights - aluminium 1 mg - 5 mg/German silver 10 mg - 500 mg
Case material: Wood. Milligram weights 1 mg - 500 mg in plastic box.



Weight set			+ DAkkS certificate		= Package price	
KERN		€	KERN	€	KERN	€
338-22	1 mg - 500 mg	143,-	962-450	100,-		243,-
333-02	1 mg - 50 g	365,-	962-401	167,-		532,-
333-03	1 mg - 100 g	405,-	962-402	178,-		583,-
333-04	1 mg - 200 g	495,-	962-403	199,-		694,-
333-05	1 mg - 500 g	570,-	962-404	210,-		780,-
333-06	1 mg - 1 kg	690,-	962-405	220,-		910,-
333-07	1 mg - 2 kg	970,-	962-406	250,-		1220,-
333-08	1 mg - 5 kg	1250,-	962-407	265,-		1515,-
333-09	1 mg - 10 kg	1750,-	962-408	285,-		2035,-
334-02	1 g - 50 g	225,-	962-415	67,-		292,-
334-03	1 g - 100 g	265,-	962-416	77,-		342,-
334-04	1 g - 200 g	360,-	962-417	98,-		458,-
334-05	1 g - 500 g	425,-	962-418	109,-		534,-
334-06	1 g - 1 kg	560,-	962-419	119,-		679,-
334-07	1 g - 2 kg	850,-	962-420	151,-		1001,-
334-08	1 g - 5 kg	1120,-	962-421	166,-		1286,-
334-09	1 g - 10 kg	1610,-	962-422	182,-		1792,-



You can create your own individual weight set yourself:

It contains only the weights which you need for testing purposes. KERN will customise your own personal box out of plastic, wood or aluminium. For more details on this, please see page 207.

Test weights class M1

Class M1 Milligram weights, flat polygonal sheet, aluminium/German silver

Test weight material: Aluminium 1 mg – 5 mg/German silver 10 mg – 500 mg
 Container material: Lined plastic



Milligram weight				+		Container		+		DAkkS certificate		=		Package price	
KERN		Tol ± mg	€	KERN	€	KERN	€	KERN	€	KERN	€	KERN	€		
348-01	1 mg	0,20	4,10	347-009-400	2,-	962-651	15,-								21,10
348-02	2 mg	0,20	4,10	347-009-400	2,-	962-652	15,-								21,10
348-03	5 mg	0,20	4,10	347-009-400	2,-	962-653	15,-								21,10
348-04	10 mg	0,25	4,10	347-009-400	2,-	962-654	15,-								21,10
348-05	20 mg	0,3	4,10	347-009-400	2,-	962-655	15,-								21,10
348-06	50 mg	0,4	4,10	347-009-400	2,-	962-656	15,-								21,10
348-07	100 mg	0,5	4,10	347-009-400	2,-	962-657	15,-								21,10
348-08	200 mg	0,6	4,10	347-009-400	2,-	962-658	15,-								21,10
348-09	500 mg	0,8	4,10	347-009-400	2,-	962-659	15,-								21,10

Class M1 Individual weights, cylindrical shape, finely turned brass or finely turned stainless steel

Test weight material: Individual weights - finely turned brass or finely turned stainless steel
 Container material: Lined plastic



Individual weight				+		Container		+		DAkkS certificate		=		Package price	
KERN		Tol ± mg	€	KERN	€	KERN	€	KERN	€	KERN	€	KERN	€		
Finely turned brass															
347-41	1 g	1,0	4,10	347-030-400	2,-	962-631	15,-								21,10
347-42	2 g	1,2	4,40	347-030-400	2,-	962-632	15,-								21,40
347-43	5 g	1,6	4,80	347-030-400	2,-	962-633	15,-								21,80
347-44	10 g	2,0	5,30	347-050-400	2,-	962-634	15,-								22,30
347-45	20 g	2,5	5,70	347-050-400	2,-	962-635	15,-								22,70
347-46	50 g	3,0	6,70	347-070-400	2,-	962-636	15,-								23,70
347-47	100 g	5,0	8,60	347-070-400	2,-	962-637	16,-								26,60
347-48	200 g	10	13,-	347-080-400	2,-	962-638	16,-								31,-
347-49	500 g	25	28,-	347-090-400	3,-	962-639	16,-								47,-
347-51	1 kg	50	43,-	347-110-400	3,-	962-641	16,-								62,-
347-52	2 kg	100	77,-	347-120-400	3,-	962-642	17,-								97,-
347-53	5 kg	250	165,-	347-130-400	9,-	962-643	17,-								191,-
347-54	10 kg	500	310,-	347-140-400	9,-	962-644	17,-								336,-
Finely turned stainless steel															
347-01	1 g	1,0	4,60	347-030-400	2,-	962-631	15,-								21,60
347-02	2 g	1,2	4,90	347-030-400	2,-	962-632	15,-								21,90
347-03	5 g	1,6	5,40	347-030-400	2,-	962-633	15,-								22,40
347-04	10 g	2,0	5,80	347-050-400	2,-	962-634	15,-								22,80
347-05	20 g	2,5	6,50	347-050-400	2,-	962-635	15,-								23,50
347-06	50 g	3,0	8,20	347-070-400	2,-	962-636	15,-								25,20
347-07	100 g	5,0	11,-	347-070-400	2,-	962-637	16,-								29,-
347-08	200 g	10	16,-	347-080-400	2,-	962-638	16,-								34,-
347-09	500 g	25	34,-	347-090-400	3,-	962-639	16,-								53,-
347-11	1 kg	50	54,-	347-110-400	3,-	962-641	16,-								73,-
347-12	2 kg	100	92,-	347-120-400	3,-	962-642	17,-								112,-
347-13	5 kg	250	196,-	347-130-400	9,-	962-643	17,-								222,-
347-14	10 kg	500	385,-	347-140-400	9,-	962-644	17,-								411,-

Class M1 Test weights, stainless steel, stackable

Test weight material: Stainless steel, finely turned
 Box material: Wood



Test weight				+		Container		+		DAkkS certificate		=		Package price	
KERN		Tol ± g	Dim. Ø x H	€	KERN	€	KERN	€	KERN	€	KERN	€			
347-141	10 kg	0,50	137x132 mm	465,-	337-141-200	190,-	962-644	17,-							672,-
347-151	20 kg	1,00	137x217 mm	530,-	337-151-200	235,-	962-645	22,-							787,-
347-161	50 kg	2,50	198x250 mm	1510,-	337-161-200	345,-	962-646	24,-							1879,-

Test weights class M1

Class M1 Weight sets, cylindrical shape, finely turned brass or finely turned stainless steel

Test weight material: Individual weights finely turned brass or finely turned stainless steel, milligram weights aluminium 1 mg - 5 mg/German silver 10 mg - 500 mg
Case material: Lined plastic. Milligram weights 1 mg - 500 mg in plastic box.



Weight set		€	+ DAkkS certificate		=	Package price	
KERN			KERN	€		KERN	€
348-22	1 mg - 500 mg	69,-	962-650	63,-			132,-
Finely turned brass							
343-424	1 mg - 50 g	149,-	962-601	106,-			255,-
343-434	1 mg - 100 g	162,-	962-602	112,-			274,-
343-444	1 mg - 200 g	191,-	962-603	125,-			316,-
343-454	1 mg - 500 g	220,-	962-604	131,-			351,-
343-464	1 mg - 1 kg	305,-	962-605	137,-			442,-
343-474	1 mg - 2 kg	485,-	962-606	152,-			637,-
343-484	1 mg - 5 kg	710,-	962-607	160,-			870,-
344-424	1 g - 50 g	81,-	962-615	42,-			123,-
344-434	1 g - 100 g	94,-	962-616	49,-			143,-
344-444	1 g - 200 g	124,-	962-617	61,-			185,-
344-454	1 g - 500 g	158,-	962-618	68,-			226,-
344-464	1 g - 1 kg	250,-	962-619	74,-			324,-
344-474	1 g - 2 kg	430,-	962-620	89,-			519,-
344-484	1 g - 5 kg	650,-	962-621	96,-			746,-
Finely turned stainless steel							
343-024	1 mg - 50 g	155,-	962-601	106,-			261,-
343-034	1 mg - 100 g	170,-	962-602	112,-			282,-
343-044	1 mg - 200 g	205,-	962-603	125,-			330,-
343-054	1 mg - 500 g	245,-	962-604	131,-			376,-
343-064	1 mg - 1 kg	335,-	962-605	137,-			472,-
343-074	1 mg - 2 kg	540,-	962-606	152,-			692,-
343-084	1 mg - 5 kg	800,-	962-607	160,-			960,-
344-024	1 g - 50 g	88,-	962-615	42,-			130,-
344-034	1 g - 100 g	102,-	962-616	49,-			151,-
344-044	1 g - 200 g	139,-	962-617	61,-			200,-
344-054	1 g - 500 g	179,-	962-618	68,-			247,-
344-064	1 g - 1 kg	285,-	962-619	74,-			359,-
344-074	1 g - 2 kg	490,-	962-620	89,-			579,-
344-084	1 g - 5 kg	750,-	962-621	96,-			846,-

Class M1 Weight sets, cylindrical shape, finely turned brass or finely turned stainless steel

Test weight material: Individual weights finely turned brass or finely turned stainless steel, milligram weights aluminium 1 mg - 5 mg/German silver 10 mg - 500 mg
Case material: Wood. Milligram weights 1 mg - 500 mg in plastic box.



Weight set		€	+ DAkkS certificate		=	Package price	
KERN			KERN	€		KERN	€
348-22	1 mg - 500 mg	69,-	962-650	63,-			132,-
Finely turned brass							
343-42	1 mg - 50 g	149,-	962-601	106,-			255,-
343-43	1 mg - 100 g	162,-	962-602	112,-			274,-
343-44	1 mg - 200 g	191,-	962-603	125,-			316,-
343-45	1 mg - 500 g	220,-	962-604	131,-			351,-
343-46	1 mg - 1 kg	305,-	962-605	137,-			442,-
343-47	1 mg - 2 kg	485,-	962-606	152,-			637,-
343-48	1 mg - 5 kg	710,-	962-607	160,-			870,-
343-49	1 mg - 10 kg	1090,-	962-608	167,-			1257,-
344-42	1 g - 50 g	81,-	962-615	42,-			123,-
344-43	1 g - 100 g	94,-	962-616	49,-			143,-
344-44	1 g - 200 g	124,-	962-617	61,-			185,-
344-45	1 g - 500 g	158,-	962-618	68,-			226,-
344-46	1 g - 1 kg	250,-	962-619	74,-			324,-
344-47	1 g - 2 kg	430,-	962-620	89,-			519,-
344-48	1 g - 5 kg	650,-	962-621	96,-			746,-
344-49	1 g - 10 kg	1020,-	962-622	104,-			1124,-

Test weights class M1

Continuation: Class M1 Weight sets, cylindrical shape, finely turned brass or finely turned stainless steel



Weight set			+ DAkkS certificate		= Package price	
KERN		€	KERN	€	KERN	€
Finely turned stainless steel						
343-02	1 mg - 50 g	155,-	962-601	106,-		261,-
343-03	1 mg - 100g	170,-	962-602	112,-		282,-
343-04	1 mg - 200 g	205,-	962-603	125,-		330,-
343-05	1 mg - 500 g	245,-	962-604	131,-		376,-
343-06	1 mg - 1 kg	335,-	962-605	137,-		472,-
343-07	1 mg - 2 kg	540,-	962-606	152,-		692,-
343-08	1 mg - 5 kg	800,-	962-607	160,-		960,-
343-09	1 mg - 10 kg	1250,-	962-608	167,-		1417,-
344-02	1 g - 50 g	88,-	962-615	42,-		130,-
344-03	1 g - 100 g	102,-	962-616	49,-		151,-
344-04	1 g - 200 g	139,-	962-617	61,-		200,-
344-05	1 g - 500 g	179,-	962-618	68,-		247,-
344-06	1 g - 1 kg	285,-	962-619	74,-		359,-
344-07	1 g - 2 kg	490,-	962-620	89,-		579,-
344-08	1 g - 5 kg	750,-	962-621	96,-		846,-
344-09	1 g - 10 kg	1190,-	962-622	104,-		1294,-

You can create your own individual weight set yourself:

It contains only the weights which you need for testing purposes. KERN will customise your own personal box out of plastic, wood or aluminium. For more details on this, please see page 207.

Newton weights (N)

All hook and slotted weights as well as beam bars are available with N adjustment according to M1 tolerances, additional price € 8,-. We need to know the location of use and postal code.

DAkkS calibration certificate for N weights: identical to DAkkS prices for individual weights M1, additional price € 8,-.

Class M1 Hook weights, finely turned brass

Test weight material: Finely turned brass

Container material: Lined plastic



Hook weight			+ Container		+ DAkkS certificate		= Package price	
KERN	Tol ± mg	€	KERN	€	KERN	€	KERN	€
347-416	1 g	1,0	12,-	347-030-400	2,-	962-631	15,-	29,-
347-426	2 g	1,2	13,-	347-030-400	2,-	962-632	15,-	30,-
347-436	5 g	1,6	14,-	347-030-400	2,-	962-633	15,-	31,-
347-446	10 g	2,0	15,-	347-050-400	2,-	962-634	15,-	32,-
347-456	20 g	2,5	16,-	347-050-400	2,-	962-635	15,-	33,-
347-466	50 g	3,0	20,-	347-070-400	2,-	962-636	15,-	37,-
347-476	100 g	5	23,-	347-090-400	3,-	962-637	16,-	42,-
347-486	200 g	10	31,-	347-090-400	3,-	962-638	16,-	50,-
347-496	500 g	25	43,-	347-110-400	3,-	962-639	16,-	62,-
347-516	1 kg	50	63,-	347-120-400	3,-	962-641	16,-	82,-
347-526	2 kg	100	104,-	347-130-400	9,-	962-642	17,-	130,-
347-536	5 kg	250	180,-	347-140-400	9,-	962-643	17,-	206,-
347-546	10 kg	500	350,-	-	-	962-644	17,-	367,-

Test weights class M1

Class M1 Slotted weights, finely turned brass

Test weight material: Finely turned brass
Container material: Lined plastic



Slotted weight				+	Container		+	DAkkS certificate		=	Package price	
KERN		Tol ± mg	€		KERN	€		KERN	€		KERN	€
347-415	1 g	1,0	14,-		347-030-400	2,-		962-631	15,-			31,-
347-425	2 g	1,2	15,-		347-030-400	2,-		962-632	15,-			32,-
347-435	5 g	1,6	16,-		347-030-400	2,-		962-633	15,-			33,-
347-445	10 g	2,0	19,-		347-030-400	2,-		962-634	15,-			36,-
347-455	20 g	2,5	20,-		347-080-400	2,-		962-635	15,-			37,-
347-465	50 g	3,0	22,-		347-080-400	2,-		962-636	15,-			39,-
347-475	100 g	5,0	25,-		347-090-400	3,-		962-637	16,-			44,-
347-485	200 g	10	30,-		347-090-400	3,-		962-638	16,-			49,-
347-495	500 g	25	48,-		347-110-400	3,-		962-639	16,-			67,-
347-515	1 kg	50	77,-		347-130-400	9,-		962-641	16,-			102,-
347-525	2 kg	100	116,-		347-130-400	9,-		962-642	17,-			142,-
347-535	5 kg	250	216,-		347-140-400	9,-		962-643	17,-			242,-
347-545	10 kg	500	376,-		347-140-400	9,-		962-644	17,-			402,-

Class M1 Beam bars, finely turned brass, for fixing slotted weights

Beam bar material: Brass, aluminium (347-445-100)



Beam bar					+	DAkkS certificate	
KERN	Size	Largest slotted weight possible	Maximum total load	€		KERN	€
347-445-100*	10 g	100 g	200 g	30,-		962-634	15,-
347-475-100**	100 g	1 kg	2 kg	50,-		962-637	16,-
347-495-100***	500 g	10 kg	20 kg	79,-		962-639	16,-
347-515-100***	1000 g	10 kg	40 kg	118,-		962-641	16,-

Class M1 Block weights, lacquered cast iron/stainless steel

Test weight material: Lacquered cast iron/stainless steel (in OIML classes F1 and F2 on request)

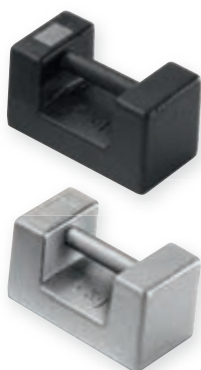

Block weight			+	DAkkS certificate		=	Package price	
KERN	Tol ± g	€		KERN	€		KERN	€
Lacquered cast iron								
346-86	5 kg	0,25	65,-	962-643	17,-			82,-
346-87	10 kg	0,50	85,-	962-644	17,-			102,-
346-88	20 kg	1,00	116,-	962-645	22,-			138,-
346-89	50 kg	2,50	320,-	962-646	24,-			344,-
Stainless steel								
346-06	5 kg	0,25	315,-	962-643	17,-			332,-
346-07	10 kg	0,50	455,-	962-644	17,-			472,-
346-08	20 kg	1,00	580,-	962-645	22,-			602,-
346-09	50 kg	2,50	1490,-	962-646	24,-			1514,-

Class M1 Heavy duty weights, cast iron, stackable

Designed to be lifted with forklift trucks or cranes



Test weight material: Lacquered cast iron

Heavy duty weight				+	DAkkS certificate	
KERN	Tol ± g	Dimensions WxDxH	€		KERN	€
346-81	100 kg	5	340x225x280 mm	1390,-	962-691	63,-
346-82	200 kg	10	465x340x291 mm	1650,-	962-692	63,-
346-83	500 kg	25	750x500x314 mm	2950,-	962-693	63,-
346-84	1000 kg	50	750x500x500 mm	4750,-	962-694	136,-
346-85	2000 kg	100	1000x750x500 mm	8700,-	962-695	250,-

Test weights class M2

Class M2 Individual weights, cylindrical shape, finely turned brass

Test weight material: finely turned brass
 Container material: Lined plastic



Individual weight				+	Container		+	DAkkS certificate		=	Package price	
KERN		Tol ± mg	€		KERN	€		KERN	€		KERN	€
357-41	1 g	3	3,60		347-030-400	2,-		962-631	15,-			20,60
357-42	2 g	4	3,90		347-030-400	2,-		962-632	15,-			20,90
357-43	5 g	5	4,30		347-030-400	2,-		962-633	15,-			21,30
357-44	10 g	6	4,70		347-050-400	2,-		962-634	15,-			21,70
357-45	20 g	8	5,20		347-050-400	2,-		962-635	15,-			22,20
357-46	50 g	10	6,20		347-070-400	2,-		962-636	15,-			23,20
357-47	100 g	16	8,-		347-070-400	2,-		962-637	16,-			26,-
357-48	200 g	30	12,-		347-080-400	2,-		962-638	16,-			30,-
357-49	500 g	80	26,-		347-090-400	3,-		962-639	16,-			45,-
357-51	1 kg	160	41,-		347-110-400	3,-		962-641	16,-			61,-
357-52	2 kg	300	69,-		347-120-400	3,-		962-642	17,-			89,-
357-53	5 kg	800	149,-		347-130-400	9,-		962-643	17,-			175,-
357-54	10 kg	1600	295,-		347-140-400	9,-		962-644	17,-			321,-

Alternative to plastic container:

Wooden boxes for individual weights. For more details on this, please see page 206

Class M2 Block weights, lacquered cast iron

Test weight material: Lacquered cast iron



Block weight				+	DAkkS certificate		=	Package price	
KERN		Tol ±g	€		KERN	€		KERN	€
356-86	5 kg	0,8	62,-		962-643	17,-			79,-
356-87	10 kg	1,6	82,-		962-644	17,-			99,-
356-88	20 kg	3,0	113,-		962-645	22,-			135,-
356-89	50 kg	8,0	310,-		962-646	24,-			334,-

Class M2 Weight sets, cylindrical shape, finely turned brass

Test weight material: Finely turned brass
 Case material: Wood



Weight set			+	DAkkS certificate		=	Package price	
KERN		€		KERN	€		KERN	€
354-42	1 g - 50 g	78,-		962-615	42,-			118,-
354-43	1 g - 100 g	89,-		962-616	49,-			138,-
354-44	1 g - 200 g	117,-		962-617	61,-			178,-
354-45	1 g - 500 g	149,-		962-618	68,-			217,-
354-46	1 g - 1 kg	245,-		962-619	74,-			319,-
354-47	1 g - 2 kg	405,-		962-620	89,-			494,-
354-48	1 g - 5 kg	610,-		962-621	96,-			706,-
354-49	1 g - 10 kg	970,-		962-622	104,-			1074,-

Test weights class M3

Class M3 Individual weights, cylindrical shape, finely turned brass

Test weight material: Finely turned brass
Container material: Lined plastic



Individual weight				+	Container		+	DAkkS certificate		=	Package price	
KERN		Tol ± mg	€		KERN	€		KERN	€		KERN	€
367-41	1 g	10	3,10		347-030-400	2,-		962-631	15,-			20,10
367-42	2 g	12	3,40		347-030-400	2,-		962-632	15,-			20,40
367-43	5 g	16	3,80		347-030-400	2,-		962-633	15,-			20,80
367-44	10 g	20	4,20		347-050-400	2,-		962-634	15,-			21,20
367-45	20 g	25	4,60		347-050-400	2,-		962-635	15,-			21,60
367-46	50 g	30	5,40		347-070-400	2,-		962-636	15,-			22,40
367-47	100 g	50	6,70		347-070-400	2,-		962-637	16,-			24,70
367-48	200 g	100	9,80		347-080-400	2,-		962-638	16,-			27,80
367-49	500 g	250	22,-		347-090-400	3,-		962-639	16,-			41,-
367-51	1 kg	500	35,-		347-110-400	3,-		962-641	16,-			54,-
367-52	2 kg	1000	59,-		347-120-400	3,-		962-642	17,-			79,-

Class M3 Individual weights, cylindrical shape, lacquered cast iron

Test weight material: Lacquered cast iron. 20 kg and 50 kg with bail



Individual weight				+	DAkkS certificate		=	Package price	
KERN		Tol ±g	€		KERN	€		KERN	€
366-91	100 g	0,05	11,-		962-637	16,-			27,-
366-92	200 g	0,10	12,-		962-638	16,-			28,-
366-93	500 g	0,25	18,-		962-639	16,-			34,-
366-94	1 kg	0,50	22,-		962-641	16,-			38,-
366-95	2 kg	1,0	40,-		962-642	17,-			57,-
366-96	5 kg	2,5	66,-		962-643	17,-			83,-
366-97	10 kg	5,0	118,-		962-644	17,-			135,-

Class M3 Block weights, lacquered cast iron

Test weight material: lacquered cast iron



Block weight				+	DAkkS certificate		=	Package price	
KERN		Tol ±g	€		KERN	€		KERN	€
366-86	5 kg	2,5	59,-		962-643	17,-			76,-
366-87	10 kg	5,0	79,-		962-644	17,-			96,-
366-88	20 kg	10	110,-		962-645	22,-			132,-
366-89	50 kg	25	300,-		962-646	24,-			324,-

Class M3 Weight sets, cylindrical, brass and lacquered cast iron

Test weight material: Brass and lacquered cast iron
Case material: Wooden block



Weight set			+	DAkkS certificate		=	Package price	
KERN		€		KERN	€		KERN	€
362-96	1 g - 1 kg	140,-		962-619	74,-			214,-
362-97	1 g - 2 kg	225,-		962-620	89,-			314,-
362-98	1 g - 5 kg	295,-		962-621	96,-			391,-
362-99	1 g - 10 kg	420,-		962-622	104,-			524,-

Test weights accessories

Tweezers, gloves, dusting brush



Tweezers to be able to safely grip small test weights						
For class	For weights	KERN	Length		Version	€
E1 – F1	1 mg – 200 g	315-243	105 mm	1	Stainless steel with silicone-coated tips	15,-
E1 – F1	500 g – 2 kg	315-245	250 mm	1	Stainless steel with silicone-coated tips	32,-
F2 – M3	1 mg – 200 g	335-240	100 mm	2	Stainless steel	6,80
E1 – M1	1 mg – 200 g	315-242	100 mm	3	Plastic	6,20



Gloves cotton, 1 pair. Help to protect the test weights when being used daily, from grease from fingers, damp etc.	
KERN	€
317-280	2,50



Gloves leather/cotton, 1 pair. Help to protect the test weights when being used daily, from grease from fingers, damp etc.	
KERN	€
317-290	6,90

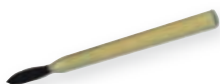

Dusting brush to clean the weights	
KERN	€
318-270	4,20

Boxes for individual weights/test weights



For weights ≤ 500 g

Box material: Lined wood
Suitable for individual weights
KERN-No. 307, 316, 317, 326, 327, 329

Wooden box for individual weights E1 – F1		
For weight	KERN	€
mg	338-090-200	14,-
1 g	317-010-100	28,-
2 g	317-020-100	28,-
5 g	317-030-100	28,-
10 g	317-040-100	28,-
20 g	317-050-100	28,-
50 g	317-060-100	28,-
100 g	317-070-100	28,-
200 g	317-080-100	28,-
500 g	317-090-100	31,-
1 kg	317-110-100	35,-
2 kg	317-120-100	44,-
5 kg	317-130-100	66,-
10 kg	317-140-100	89,-
20 kg	317-150-100	340,-
50 kg	317-160-100	415,-



For weights ≥ 1 kg



For weights ≥ 10 kg

Wooden box for check weights F2, M1		
For weight	KERN	€
10 kg	337-141-200	190,-
20 kg	337-151-200	235,-
50 kg	337-161-200	345,-



For weights ≤ 500 g

Box material: Wood
Suitable for individual weights
KERN-No. 337, 347, 357, 367

Wooden box for individual weights F2 – M3		
For weight	KERN	€
mg	338-090-200	14,-
1 g	337-010-200	14,-
2 g	337-020-200	14,-
5 g	337-030-200	14,-
10 g	337-040-200	14,-
20 g	337-050-200	14,-
50 g	337-060-200	15,-
100 g	337-070-200	15,-
200 g	337-080-200	16,-
500 g	337-090-200	19,-
1 kg	337-110-200	24,-
2 kg	337-120-200	27,-
5 kg	337-130-200	47,-
10 kg	337-140-200	61,-
20 kg	337-150-200	220,-
50 kg	337-160-200	345,-



For weights ≥ 1 kg



For weights ≥ 10 kg

Aluminium box for individual weights, cylindrical shape, class E1, E2, F1 and F2		
Largest possible weight	KERN	€
10 kg	317-140-600	245,-
20 kg	317-150-600	275,-

Test weights accessories

Cases/boxes for individual weight sets

Individual weight sets:

You can create your own "tailor-made" individual weight sets yourself. KERN will customise your own personal wooden box/plastic carrying case. The largest individual weight which will fit is given in the table.

Sample order:

Your individual weight set:
1 x 50 g, 2 x 100 g, 1 x 500 g, 2 x 1 kg, 1 x 2 kg.

The correct individual box is **KERN-Nr. 313-080-400** (plastic) or **KERN-Nr. 315-070-100** (wood).



Plastic case for individual weight sets classes E2 – M3, not appropriate for cast iron weights		
KERN	Largest possible weight	€
313-050-400	≤ 500 g	82,-
313-080-400	≤ 5 kg	180,-



Wooden box for individual weight sets classes E1 – F1		
KERN	Largest possible weight	€
315-040-100	≤ 200 g	124,-
315-060-100	≤ 1 kg	185,-
315-070-100	≤ 2 kg	245,-
315-080-100	≤ 5 kg	350,-
315-090-100	≤ 10 kg	465,-



Wooden box for individual weight set classes F2 – M3		
KERN	Largest possible weight	€
335-040-200	≤ 200 g	58,-
335-050-200	≤ 500 g	61,-
335-060-200	≤ 1 kg	108,-
335-070-200	≤ 2 kg	134,-
335-080-200	≤ 5 kg	210,-
335-090-200	≤ 10 kg	300,-

Plastic carrying case for standard weight sets

Aluminium case

for safe storage and transportation under harsh industrial conditions.



Plastic case for weight sets with standard denomination classes E2 – M3, not appropriate for cast iron weights		
KERN	Largest possible weight	€
313-052-400	≤ 500 g	55,-
313-082-400	≤ 5 kg	154,-



Aluminium case for weight sets with standard denomination classes E1, E2		
KERN	Largest possible weight	€
313-042-600	≤ 200 g	230,-
313-062-600	≤ 1 kg	310,-
313-082-600	≤ 5 kg	390,-
313-090-600	≤ 10 kg	470,-

Weight carriers for block weights or other test weights

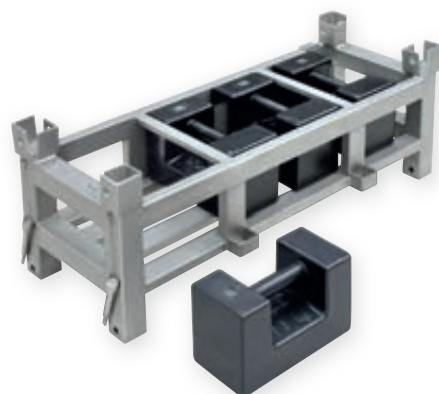

Individual weight carriers for testing high capacity floor scales, pallet scales, pallet truck scales, crane scales, etc. This can also be used for storing the weights.

This means the weight container and the weights can be placed on the scale in one go, saving time and money.

The weight container can be calibrated to OIML accuracy classes M1 – M3.

On request, KERN will make you a "tailor-made" weight carrier to your specifications.

Example:

9 block weights	each 50 kg, class M1 =	450 kg
1 weight container	each 50 kg, class M1 =	50 kg
Total		= 500 kg

The Deutsche Akkreditierungsstelle GmbH (DAkkS) (German accreditation body)

The Deutsche Akkreditierungsstelle GmbH (DAkkS), successor of the German Calibration Service (DKD), is responsible for measuring “correctly” in accordance with legally binding international standards. It is part of DAkkS = Deutsche Akkreditierungsstelle (German accreditation authority) which was founded in Germany. The basis is the European range of standards DIN EN ISO/IEC 17000 for conformity assessment, in particular the accreditation standard 17025, which governs the organisation of a calibration laboratory, as well as basic metrological technical requirements.

Only an accredited calibration laboratory can issue a DAkkS calibration (DKD) certificate. This defines not only the measuring method as well as the measuring result, but also gives information on tracing the test medium to national standards and the relevant uncertainty of measurement.

- ➔ **You are certified to ...**
ISO 9001, QS 9000, GLP, GMP, TS16949
- ➔ **You need ...**
to control your measuring equipment
- ➔ **Our solution ...**
DAkkS calibration certificate (DKD); (traceability, measuring uncertainty, internationally recognised)

KERN – Precision is our business

The KERN calibration laboratory for electronic balances and weights has been DKD accredited since 1994 and today it is one of the most modern and best-equipped DAkkS calibration laboratories for balances, test weights and force measurement in Europe.

Thanks to the high level of automation, we can carry out DAkkS calibration (DKD) of balances, test weights and force-measuring devices 24 hours a day, 7 days a week.

Do you have any further requests or questions on this matter? We would be pleased to help you or visit us on the web at www.kern-lab.com

Range of services:

- DAkkS calibration (DKD) of balances with a maximum load of up to 50.000 kg
- DAkkS calibration (DKD) of weights in the range of 1 mg – 2.500 kg. Calibrations can be carried out in the following classes: E1, E2, F1, F2, M1, M2, M3
- Database supported management of checking equipment and reminding service

- In combination with periodic recalibration we can offer you a wide range of further services:
 - Reconditioning of weights, e.g. cast weights (sand blasting, painting, adjustment etc.)
 - Collection service with special transport packaging, even for heavy weights
 - Volume determination for weights of accuracy class E1
 - Measuring of sensitivity (magnetic characteristics)
- Calibration of force-measuring devices
- DAkkS calibration certificates in the following languages DE, GB, FR, IT, ES, NL

DAkkS calibration (DKD)

Why? DAkkS calibration (DKD) is always necessary when checking equipment (balance or test weight) is to be used in a QM process (e.g. to ISO 9000ff, GS 9000, TS 16949, VDA 6.1, FDA, GLP, GMP, GMP etc.)

What? Any checking equipment in proper condition can be DAkkS calibrated (DKD)

How? Determination of accuracy throughout the world by a laboratory which is accredited to DIN EN ISO 17025. Traceability to internationally recognised standards. The DAkkS calibration (DKD) certificate confirms both the measurement characteristics of the checking equipment and the general requirements for the control of checking equipment.

Where? Internationally recognised – this is monitored by ILAC (International Laboratory Accreditation Cooperation) and e.g. DAkkS (German calibration service) in Germany

When? Operator control the use of checking equipment and periodic recalibration time intervals themselves



Martin Goltz
Product specialist Calibration service

Tel. +49 [0] 7433 9933- 151
Fax +49 [0] 7433 9933- 172
goltz@kern-sohn.com

Calibration service for balances (DAkKS calibration)

The advantages of using the KERN in-house calibration

You send your balance to us.

Recommendable with new equipment and for balances which can be transported economically, as the travel costs for on-site calibration are then not applied. On request, we can also provide a pick-up and collection service with our parcel service.

The advantages of using the KERN on-site calibration

We visit you.

In Germany, KERN has access to a comprehensive network of employees at the KERN DAkKS calibration laboratory, who can carry out on-site calibration of scales up to 50 t.

The calibration service is **independent of the brand**.

Preliminary maintenance work by agreement.
Prices for on-site calibration on request.

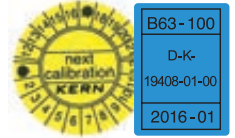

Recalibration

- The recalibration schedule depends on the frequency of use, the conditions of use and the safety requirements.
- We would recommend that you recalibrate your balances every 6 months if they are used intensively, and every 12 months with normal use.

Initial calibration and recalibration of balance at the KERN factory	KERN	Price excl. of VAT ex works €
Weighing range		
Analytical balances		
[Max] ≤ 5 kg	963-101	138,-
[Max] > 5 kg	963-102	176,-
Precision balances/Industrial scales		
[Max] ≤ 5 kg	963-127	72,-
[Max] > 5 kg – 50 kg	963-128	88,-
[Max] > 50 kg – 350 kg	963-129	105,-
[Max] > 350 kg – 1500 kg	963-130	165,-
[Max] > 1500 kg – 2900 kg ¹⁾	963-131	220,-
[Max] > 2900 kg – 6000 kg ¹⁾	963-132	440,-
[Max] > 6000 kg – 12000 kg ¹⁾	963-133	500,-
Hanging scales/Crane scales		
[Max] ≤ 5 kg	963-127H	72,-
[Max] > 5 kg – 50 kg	963-128H	88,-
[Max] > 50 kg – 350 kg	963-129H	105,-
[Max] > 350 kg – 1500 kg	963-130H	165,-
[Max] > 1500 kg – 2900 kg	963-131H	250,-
[Max] > 2900 kg – 6000 kg	963-132H	500,-
[Max] > 6000 kg – 12000 kg ³⁾	963-133H	700,-
[Max] > 12000 kg – 31000 kg ⁴⁾ (recalibration only)	963-134HR	830,-
[Max] > 31000 kg – 50000 kg ⁴⁾ (recalibration only)	963-135HR	830,-
Preparation for recalibration (cleaning, adjustment, function test)	969-003R	20,-
Additional services		
Minimum weight of sample (for details see internet)	969-103	10,-
DAkKS Express service with delivery time 48 hours (only on initial purchase, details see p. 188)	962-116	50,-/scale
Express shipping: Express supplement for guaranteed delivery on the next working day (if ready for shipment before 12:00 noon)	in GER only	40,-/parcel

- ¹⁾ Floor scales & axle load scales only (Price per weighing panel). Please ask for further details.
²⁾ On request
³⁾ Processing time 4 working days
⁴⁾ Processing time 15 working days

KERN & Sohn GmbH

Älteste europäische Feinwaagen und Gewichtefabrik seit 1844
 Oldest European Manufacturer of Precision Balances since 1844

akkreditiert durch die / accredited by the
Deutsche Akkreditierungsstelle GmbH
 als Kalibrierlaboratorium im / as calibration laboratory in
Deutschen Kalibrierdienst DKD

Kalibrierschein / Calibration Certificate **1**

Kalibrierzeichen / Calibration mark

Sample	D-K	19408-01-00
2014-05		

Gegenstand / Object **2**: Präzisionswaage / Precision Balance

Hersteller / Manufacturer **3**: KERN & Sohn GmbH, Ziegelsel 1, 72336 Balingen, GERMANY

Typ / Type **4**: PLJ 600-3CM

Fabrikate/Serien-Nr. / Serial number: 123456789

Hersteller / Manufacturer: Mustermann GmbH

Dieser Kalibrierschein dokumentiert die Rückführung auf nationale Normale zur Darstellung der Einheiten in Übereinstimmung mit dem Internationalen Einheitensystem (SI). Die DAkKS ist Unterzeichner der multilateralen Übereinkommen der European co-operation for Accreditation (EA) und der International Laboratory Accreditation Cooperation (ILAC) zur gegenseitigen Anerkennung der Kalibrierscheine. Für die Einhaltung einer angemessenen Frist zur Kalibrierung ist...

Messergebnisse / Measurement results

1. Wiederholbarkeit / Repeatability

Messung / Measurement	Prüflast / Load	Waagenanzeige / Indication
No. 1	500 g	499,999 g
No. 2	500 g	499,999 g
No. 3	500 g	500,000 g
No. 4	500 g	500,000 g
No. 5	500 g	500,000 g

Standardabweichung: s = 0,0006 g
 Standard deviation:

2. Richtigkeit / Linearity

Prüflast / Load	Waagenanzeige / Indication
100 g	100,000 g
200 g	200,000 g
300 g	300,001 g
500 g	500,000 g
600 g	600,001 g

3. Außermittige Belastung / Eccentricity

Position / Position	Prüflast / Load	Waagenanzeige / Indication
No. 1	500 g	500,000 g
No. 2	500 g	499,999 g
No. 3	500 g	500,001 g
No. 4	500 g	500,001 g
No. 5	500 g	500,001 g

Standardabweichung: s = 0,0006 g
 Standard deviation:

Messunsicherheit U / Measuring uncertainty U

Last / Load	Abweichung / Error	Erweiterungsfaktor k / Coverage factor	Unsicherheit / Uncertainty	relative Unsicherheit / Rel. uncertainty
100 g	0,000 g	2,38	0,0016 g	0,00154 %
200 g	0,000 g	2,32	0,0016 g	0,00078 %
300 g	0,001 g	2,24	0,0017 g	0,00053 %
500 g	0,000 g	2,12	0,0018 g	0,00036 %
600 g	0,001 g	2,06	0,0020 g	0,00032 %

Darstellung im Diagramm / Representation as chart **6**

Abweichung / Error in g vs Nettobelastung / Net-Load in g

Verwendungsgenauigkeit G / Usage accuracy G

Diagramm der Verwendungsgenauigkeit / Graph of usage accuracy:

$$G = 0,0013 \text{ g} + 8,72 \cdot 10^{-6} \cdot m_w$$

m_w = Nettoanzeige bei zunehmender Belastung / net display with increasing load

Verwendungsgenauigkeit / Usage accuracy in g vs Last / Load in g

rel. Meßunsicherheit

rel. Meßunsicherheit vs Nettobelastung / Net-Load in g

Mindesteinwaage / Minimum weight of sample

DAkKS calibration certificate for balances (extract)

- | | |
|-------------------------------------|--|
| 1 Official document | 6 Measuring uncertainty, see page 215 |
| 2 Item to be calibrated | 7 Usage accuracy, see page 216 |
| 3 Traceability, see page 216 | 8 Minimum weight of sample (additional price) |
| 4 Identification/Applicant | |
| 5 Metrological component | |

Calibration service for test weights (DAkKS calibration)

Calibration of test weights

Calibrated measuring equipment requires calibrated checking equipment. For balances, these are calibrated test weights, also called "standard weights".

We calibrate test weights

- In all classes with permissible error limits E1 – M3 according to OIML R111-2004 (for tolerance tables, see page 190), in sizes 1 mg to 2500 kg.
- With free nominal value
- Newton (N)
- Independent of design (special designs)

The advantages of using the KERN in-house calibration

You send your test weights to us.

- Excellent price performance ratio
- The quickest processing time
 - DAkKS standard service: 4 working days
 - DAkKS express service: 48 hrs (new weights)
- The most modern calibration methods with robot controlled comparators allow the most accurate calibration results and fastest throughput time
- KERN DAkKS calibration certificates are internationally recognised
- A calibration service which is independent of the brand
- KERN also reconditions existing customer weights (e.g. cleaning or readjustment)
- On request, we can also provide a pick-up and collection service with our parcel service

The advantages of using the KERN on-site calibration

We visit you.

We would be pleased to visit you within Germany and carry out the calibration of your reference standards to OIML classes M1 – M3, 10 kg, 20 kg, 25 kg, 40 kg, 50 kg with permissible error limits, using our mobile MACOS system. Minimized downtime of your checking equipment and direct contact with our expert are the major benefits of this service. Price on request.

Recalibration

- The recalibration schedule depends on the frequency of use, the conditions of use and the safety requirements.
- In terms of standardisation, no particular recalibration interval is specified.
- We would recommend that you recalibrate your test weights every 6 months if they are used intensively, and every 12 months with normal use.
- We would be pleased to monitor your recalibration schedule.

1 Official document

- 2 Item to be calibrated
- 3 Traceability, see page 216
- 4 Identification/Applicant

5 Environmental conditions

- 6 Metrological component
- 7 Conventional mass
- 8 Measuring uncertainty, see page 215



KERN & Sohn GmbH
Älteste europäische Feinwaagen und Gewichtfabrik seit 1844
 Oldest European Manufacturer of Precision Balances since 1844

akkreditiert durch die / accredited by the
Deutsche Akkreditierungsstelle GmbH
 als Kalibrierlaboratorium im / as calibration laboratory in the
Deutschen Kalibrierdienst 

Kalibrierschein
Calibration certificate

1

Kalibrierzeichen
Calibration mark

D-K
19408-01-00
2014-05

Gegenstand
Object

Hersteller
Manufacturer

Typ
Type

Fabrikate/Serien-Nr.
Serial number

Auftraggeber
Customer

Auftragsnummer
2014-123456789

Gewichtssatz, 1 mg - 1 kg
Klasse E2

Satz of weights, 1 mg - 1 kg
Class E2

KERN & Sohn GmbH
Ziegelei 1
D-72336 Balingen
Germany

313-052

G123456789

Mustermann GmbH
Teststr. 1
42446 Musterstadt
Deutschland

Dieser Kalibrierschein dokumentiert die Rückführung auf nationale Normale zur Darstellung der Einheiten in Übereinstimmung mit dem Internationalen Einheitensystem (SI). Die DAkKS ist Unterzeichner der multilateralen Übereinkommen der Europäischen Kooperation für Akkreditation (EA) und der International Laboratory Accreditation Cooperation (ILAC) zur gegenseitigen Anerkennung der Kalibrierscheine. Für die Einhaltung seiner angemessenen Frist zur Wiederholung der Kalibrierung ist der Benutzer verantwortlich.

This calibration certificate documents the traceability to national standards, which realize the units of measurement according to the International System of Units (SI). The DAkKS is signatory to the multilateral agreements of the European co-operation for Accreditation (EA) and of the International Laboratory Accreditation (ILAC).

Kalibrierverfahren:
Calibration method

Umgebungsbedingungen:
Ambient conditions

	von from	bis to	Unsicherheit uncertainty
Temperatur (°C) <small>temperature</small>	22,9	24,1	0,1
rel. Luftfeuchte (%) <small>relative humidity</small>	48,5	53,4	2,0
Luftdruck (hPa) <small>air pressure</small>	942,5	948,5	0,3

Referenzgewichte:
Standard weights

G1-123-D-K-19408-01-00-2014-05

Material / angenommene Dichte:
Material / assumed density

Nennwert nominal value	Dichte density	Unsicherheit uncertainty	Material material	Form shape
1 mg - 500 mg	7950 kg/m ³	140 kg/m ³	Edelstahl Stainless steel	Draht Wire
1 g - 1 kg	8000 kg/m ³	100 kg/m ³	Edelstahl Stainless steel	Knopf Cylindrical form

Messergebnisse:
Measurement results:

Nennwert nominal value	Kennzeichnung marking	konventioneller Wägewert conventional mass	Unsicherheit k=2 uncertainty	Fehlergrenze max. perm. error	Klasse* class*
1 mg		1 mg + 0,0010 mg	0,0020 mg	± 0,0060 mg	E2 ✓
2 mg		2 mg + 0,0005 mg	0,0020 mg	± 0,0060 mg	E2 ✓
2 mg	*	2 mg + 0,0016 mg	0,0020 mg	± 0,0060 mg	E2 ✓
5 mg		5 mg + 0,0010 mg	0,0020 mg	± 0,0060 mg	E2 ✓
10 mg		10 mg + 0,0009 mg	0,0020 mg	± 0,0080 mg	E2 ✓
20 mg		20 mg - 0,001 mg	0,003 mg	± 0,010 mg	E2 ✓
20 mg	*	20 mg + 0,001 mg	0,003 mg	± 0,010 mg	E2 ✓
50 mg		50 mg + 0,001 mg	0,004 mg	± 0,012 mg	E2 ✓
100 mg		100 mg + 0,001 mg	0,005 mg	± 0,016 mg	E2 ✓
200 mg		200 mg + 0,002 mg	0,006 mg	± 0,020 mg	E2 ✓
200 mg	*	200 mg + 0,003 mg	0,006 mg	± 0,020 mg	E2 ✓
500 mg		500 mg + 0,005 mg	0,008 mg	± 0,025 mg	E2 ✓
1 g		1 g + 0,002 mg	0,010 mg	± 0,030 mg	E2 ✓
2 g		2 g + 0,002 mg	0,013 mg	± 0,040 mg	E2 ✓
2 g	*	2 g + 0,002 mg	0,013 mg	± 0,040 mg	E2 ✓
5 g		5 g + 0,010 mg	0,016 mg	± 0,050 mg	E2 ✓
10 g		10 g - 0,007 mg	0,020 mg	± 0,060 mg	E2 ✓
20 g		20 g + 0,005 mg	0,026 mg	± 0,080 mg	E2 ✓
20 g	*	20 g + 0,015 mg	0,026 mg	± 0,080 mg	E2 ✓
50 g		50 g + 0,02 mg	0,03 mg	± 0,10 mg	E2 ✓
100 g		100 g + 0,01 mg	0,05 mg	± 0,16 mg	E2 ✓
200 g		200 g + 0,05 mg	0,10 mg	± 0,30 mg	E2 ✓
200 g	*	200 g - 0,00 mg	0,10 mg	± 0,30 mg	E2 ✓
500 g		500 g + 0,10 mg	0,26 mg	± 0,80 mg	E2 ✓
1 kg		1 kg + 0,1 mg	0,5 mg	± 1,6 mg	E2 ✓

DAkKS calibration certificate for test weights (extract)

For more details on our calibration service and other useful information, please see the internet on www.kern-lab.com

Note:

For more information on this subject, please see our KERN DAkKS calibration service brochure – just request your free copy.

210 Calibration service

Calibration hotline: +49 [0] 7433 9933-0 · Internet: www.kern-lab.com

18

Recalibration price of test weights (DAkkS calibration)

Class acc. OIML R111-2004 →	E1 with volume determination		E1 without volume determination		E2		F1/F2 * F2 only		M1/M2/M3	
	Nominal value ↓	KERN	Price € excl. of VAT ex works	KERN	Price € excl. of VAT ex works	KERN	Price € excl. of VAT ex works	KERN	Price € excl. of VAT ex works	KERN
1 mg	-	-	962-251R	52,-	962-351R	26,-	962-451R	18,-	962-651R	15,-
2 mg	-	-	962-252R	52,-	962-352R	26,-	962-452R	18,-	962-652R	15,-
5 mg	-	-	962-253R	52,-	962-353R	26,-	962-453R	18,-	962-653R	15,-
10 mg	-	-	962-254R	52,-	962-354R	26,-	962-454R	18,-	962-654R	15,-
20 mg	-	-	962-255R	52,-	962-355R	26,-	962-455R	18,-	962-655R	15,-
50 mg	-	-	962-256R	52,-	962-356R	26,-	962-456R	18,-	962-656R	15,-
100 mg	-	-	962-257R	52,-	962-357R	26,-	962-457R	18,-	962-657R	15,-
200 mg	-	-	962-258R	52,-	962-358R	26,-	962-458R	18,-	962-658R	15,-
500 mg	-	-	962-259R	52,-	962-359R	26,-	962-459R	18,-	962-659R	15,-
1 g	963-231	193,-	962-231R	52,-	962-331R	26,-	962-431R	18,-	962-631R	15,-
2 g	963-232	193,-	962-232R	52,-	962-332R	26,-	962-432R	18,-	962-632R	15,-
5 g	963-233	193,-	962-233R	52,-	962-333R	26,-	962-433R	18,-	962-633R	15,-
10 g	963-234	193,-	962-234R	52,-	962-334R	26,-	962-434R	18,-	962-634R	15,-
20 g	963-235	193,-	962-235R	52,-	962-335R	26,-	962-435R	18,-	962-635R	15,-
50 g	963-236	193,-	962-236R	52,-	962-336R	26,-	962-436R	18,-	962-636R	15,-
100 g	963-237	193,-	962-237R	52,-	962-337R	33,-	962-437R	20,-	962-637R	16,-
200 g	963-238	193,-	962-238R	52,-	962-338R	33,-	962-438R	20,-	962-638R	16,-
500 g	963-239	193,-	962-239R	52,-	962-339R	33,-	962-439R	20,-	962-639R	16,-
1 kg	963-241	193,-	962-241R	52,-	962-341R	33,-	962-441R	20,-	962-641R	16,-
2 kg	963-242	465,-	962-242R	64,-	962-342R	41,-	962-442R	25,-	962-642R	17,-
5 kg	963-243	465,-	962-243R	64,-	962-343R	41,-	962-443R	25,-	962-643R	17,-
10 kg	963-244	465,-	962-244R	64,-	962-344R	41,-	962-444R	25,-	962-644R	17,-
20 kg	963-245	1160,-	962-245R	590,-	962-345R	52,-	962-445R	28,-	962-645R	22,-
50 kg	963-246	1360,-	962-246R	660,-	962-346R	64,-	962-446R	39,-	962-646R	24,-
100 kg	-	-	-	-	-	-	962-591R*	116,-	962-691R	63,-
200 kg	-	-	-	-	-	-	962-592R*	116,-	962-692R	63,-
500 kg	-	-	-	-	-	-	962-593R*	116,-	962-693R	63,-
1000 kg	-	-	-	-	-	-	-	-	962-694R	136,-
2000 kg	-	-	-	-	-	-	-	-	962-695R	250,-
1 mg – 500 mg	-	-	962-250R	350,-	962-350R	190,-	962-450R	100,-	962-650R	63,-
1 mg – 50 g	963-201	1070,-	962-201R	560,-	962-301R	315,-	962-401R	167,-	962-601R	106,-
1 mg – 100 g	963-202	1170,-	962-202R	580,-	962-302R	340,-	962-402R	178,-	962-602R	112,-
1 mg – 200 g	963-203	1350,-	962-203R	630,-	962-303R	385,-	962-403R	199,-	962-603R	125,-
1 mg – 500 g	963-204	1440,-	962-204R	660,-	962-304R	410,-	962-404R	210,-	962-604R	131,-
1 mg – 1 kg	963-205	1530,-	962-205R	700,-	962-305R	435,-	962-405R	220,-	962-605R	137,-
1 mg – 2 kg	963-206	2000,-	962-206R	750,-	962-306R	495,-	962-406R	250,-	962-606R	152,-
1 mg – 5 kg	963-207	2450,-	962-207R	770,-	962-307R	530,-	962-407R	265,-	962-607R	160,-
1 mg – 10 kg	963-208	2900,-	962-208R	800,-	962-308R	560,-	962-408R	285,-	962-608R	167,-
1 g – 50 g	963-215	770,-	962-215R	245,-	962-315R	127,-	962-415R	67,-	962-615R	42,-
1 g – 100 g	963-216	860,-	962-216R	270,-	962-316R	150,-	962-416R	77,-	962-616R	49,-
1 g – 200 g	963-217	1040,-	962-217R	320,-	962-317R	196,-	962-417R	98,-	962-617R	61,-
1 g – 500 g	963-218	1130,-	962-218R	350,-	962-318R	220,-	962-418R	109,-	962-618R	68,-
1 g – 1 kg	963-219	1230,-	962-219R	375,-	962-319R	245,-	962-419R	119,-	962-619R	74,-
1 g – 2 kg	963-220	1780,-	962-220R	425,-	962-320R	305,-	962-420R	151,-	962-620R	89,-
1 g – 5 kg	963-221	2230,-	962-221R	450,-	962-321R	340,-	962-421R	166,-	962-621R	96,-
1 g – 10 kg	963-222	2690,-	962-222R	485,-	962-322R	370,-	962-422R	182,-	962-622R	104,-

Additional costs for preparation, overhaul and adjustment before the calibration	KERN	Price € excl. of VAT ex works
Preparation of weights (e.g. cleaning, etc.)		
Single weight	969-001R	3,-
Weight set	969-002R	16,-
Subsequent services are carried out after confirmation		
Continued overhaul of weights (e.g. wet-cleaning, markings, repair, special packaging, adjustment E1 (DAkkS only), E2 ...)	969-005R	T & M basis
Adjustment, per weight only available for weights with adjustment chamber (F1 - M3)	969-010R	12,-
Second calibration after adjustment or substitution, per weight		
Class E1	969-210R	40,-
Class E1 incl. volume determination	969-211R	80,-
Class E2	969-310R	14,-
Class F1/F2	969-410R	14,-
Class M1 - M3	969-610R	14,-
Testing of magnetic properties according to OIML R111-2004, per weight	972-000	12,-
Calibration of NON-OIML test weights, additional price per weight	-	8,-

KERN DAkkS Express Service	
DAkkS standard service Class E2 - M3	4 working days
DAkkS standard service Class E1, 1 mg - 500 mg, and recalibration 1 g - 10 kg with a known volume	10 working days
Class E1, 1 g - 2 kg, incl. volume determination (new weights)	15 working days
Class E1, ≥ 2 kg, incl. volume determination (new weights)	15 working days
 DAkkS Express service in 48 hours except for class E1	
<ul style="list-style-type: none"> Urgent order is received at KERN by 12:00 noon at the latest Ready for shipping at KERN within two working days, at 12:00 noon Return by standard parcel service or express shipping (Costs and processing time on request) Additional cost for DAkkS Express Service, for each KERN test weight KERN 962-115 € 20,- For Express shipping, see page 209 	

Verification prices for test weights

Class acc. → OIML R111-2004	E2 with verification certificate		F1/F2 with verification certificate		M1 with verification certificate	
	Nominal value ↓ KERN	Price excl. of VAT ex works €	KERN	Price excl. of VAT ex works €	KERN	Price excl. of VAT ex works €
1 mg	952-351	40,-	952-451	35,-	952-651	24,-
2 mg	952-352	40,-	952-452	35,-	952-652	24,-
5 mg	952-353	40,-	952-453	35,-	952-653	24,-
10 mg	952-354	40,-	952-454	35,-	952-654	24,-
20 mg	952-355	40,-	952-455	35,-	952-655	24,-
50 mg	952-356	40,-	952-456	35,-	952-656	24,-
100 mg	952-357	40,-	952-457	35,-	952-657	24,-
200 mg	952-358	40,-	952-458	35,-	952-658	24,-
500 mg	952-359	40,-	952-459	35,-	952-659	24,-
1 g	952-331	40,-	952-431	35,-	952-631	24,-
2 g	952-332	40,-	952-432	35,-	952-632	24,-
5 g	952-333	40,-	952-433	35,-	952-633	24,-
10 g	952-334	40,-	952-434	35,-	952-634	24,-
20 g	952-335	40,-	952-435	35,-	952-635	24,-
50 g	952-336	40,-	952-436	35,-	952-636	24,-
100 g	952-337	45,-	952-437	35,-	952-637	24,-
200 g	952-338	45,-	952-438	36,-	952-638	24,-
500 g	952-339	45,-	952-439	36,-	952-639	24,-
1 kg	952-341	45,-	952-441	36,-	952-641	24,-
2 kg	952-342	51,-	952-442	40,-	952-642	25,-
5 kg	952-343	51,-	952-443	40,-	952-643	25,-
10 kg	952-344	51,-	952-444	40,-	952-644	32,-
20 kg	952-345	59,-	952-445	42,-	952-645	36,-
50 kg	952-346	67,-	952-446	50,-	952-646	37,-
1 mg – 500 mg	952-350	200,-	952-450	105,-	952-650	66,-
1 mg – 50 g	952-301	330,-	952-401	175,-	952-601	111,-
1 mg – 100 g	952-302	360,-	952-402	187,-	952-602	117,-
1 mg – 200 g	952-303	405,-	952-403	210,-	952-603	131,-
1 mg – 500 g	952-304	430,-	952-404	220,-	952-604	137,-
1 mg – 1 kg	952-305	455,-	952-405	230,-	952-605	144,-
1 mg – 2 kg	952-306	520,-	952-406	260,-	952-606	159,-
1 mg – 5 kg	952-307	560,-	952-407	280,-	952-607	168,-
1 mg – 10 kg	952-308	590,-	952-408	300,-	952-608	175,-
1 g – 50 g	952-315	133,-	952-415	76,-	952-615	50,-
1 g – 100 g	952-316	157,-	952-416	81,-	952-616	54,-
1 g – 200 g	952-317	205,-	952-417	103,-	952-617	64,-
1 g – 500 g	952-318	235,-	952-418	114,-	952-618	71,-
1 g – 1 kg	952-319	255,-	952-419	125,-	952-619	78,-
1 g – 2 kg	952-320	320,-	952-420	158,-	952-620	93,-
1 g – 5 kg	952-321	355,-	952-421	174,-	952-621	101,-
1 g – 10 kg	952-322	390,-	952-422	191,-	952-622	109,-

KERN verification delivery time	
Standard verification service Class E2 – M1	6 working days

Additional costs for preparation, overhaul and adjustment before the verification	KERN	Price excl. of VAT ex works €
Preparation of weights (e.g. cleaning, etc.)		

Single weight	969-008R	3,-
Weight set	969-009R	16,-

Subsequent services are carried out after confirmation

Continued overhaul of weights (e.g. wet-cleaning, markings, repair, special packaging, adjustment E2 ...)	969-005R	T & M basis
---	----------	-------------

Adjustment, per weight only available for weights with adjustment chamber (F1/F2 – M1)	969-010R	12,-
--	----------	------

Verification after adjustment or substitution, per weight

Class E2	969-310R	14,-
Class F1/F2	969-410R	14,-
Class M1/M3	969-610R	14,-

Verification prices for electronic balances (electronic crane scales, see page 213)

Checking equipment	Initial verification	Price excl. of VAT ex works €	Subsequent verification	Price excl. of VAT ex works €
	KERN	€	KERN	€
Electronic balances, class I, [Max] ≤ 5 kg ¹⁾	965-201	110,-	950-101R	180,-
Electronic balances, class I, [Max] > 5 kg ¹⁾	965-202	110,-	950-102R	230,-
Electronic balances, class II, [Max] ≤ 5 kg ¹⁾	965-216	66,-	950-116R	90,-
Electronic balances, class II, [Max] > 5 kg – 50 kg ¹⁾	965-217	77,-	950-117R	110,-
Electronic balances, class II, [Max] > 50 kg – 350 kg ¹⁾	965-218	110,-	950-118R	170,-
Electronic balances, class III-IV, [Max] ≤ 5 kg ¹⁾	965-227	55,-	950-127R	86,-
Electronic balances, class III-IV, [Max] > 5 kg – 50 kg ¹⁾	965-228	55,-	950-128R	86,-
Electronic balances, class III-IV, [Max] > 50 kg – 350 kg ¹⁾	965-229	93,-	950-129R	138,-
Electronic balances, class III-IV, [Max] > 350 kg – 1500 kg ¹⁾	965-230	132,-	950-130R	200,-
Electronic balances, class III-IV, [Max] > 1500 kg – 2900 kg ¹⁾	965-231	220,-	950-131R	280,-
Electronic balances, class III-IV, [Max] > 2900 kg – 6000 kg ¹⁾	965-232	320,-	950-132R	430,-

¹⁾ processing time 4 working days, ²⁾ processing time 15 working days

Verification prices for electronic crane scales

Checking equipment	Initial verification	Price excl. of VAT ex works	Subsequent verification	Price excl. of VAT ex works
	KERN	€	KERN	€
Electronic crane scales, class III-IV, [Max] > 50 kg – 350 kg ¹⁾	950-129H	105,-	950-129HR	150,-
Electronic crane scales, class III-IV, [Max] > 350 kg – 1500 kg ¹⁾	950-130H	200,-	950-130HR	250,-
Electronic crane scales, class III-IV, [Max] > 1500 kg – 2900 kg ¹⁾	950-131H	270,-	950-131HR	360,-
Electronic crane scales, class III-IV, [Max] > 2900 kg – 6000 kg ¹⁾	950-132H	500,-	950-132HR	550,-
Electronic crane scales, class III-IV, [Max] > 6000 kg – 12000 kg ¹⁾	950-133H	700,-	950-133HR	870,-
Electronic crane scales, class III-IV, [Max] > 12000 kg – 31000 kg ²⁾	-	-	950-134HR	1060,-
Electronic crane scales, class III-IV, [Max] > 31000 kg – 50000 kg ²⁾	-	-	950-135HR	1060,-

¹⁾ processing time 4 working days, ²⁾ processing time 15 working days

Factory calibration certificates (ISO calibration)

Mechanical hanging scales, prices for initial calibration and recalibration

Checking equipment	Initial calibration	Recalibration	Price excl. of VAT ex works
	KERN	KERN	€
Mechanical hanging scales (spring scales) [Max] ≤ 5 kg	961-100	961-100R	72,-
Mechanical hanging scales [Max] > 5 kg – 50 kg	961-101	961-101R	88,-
Mechanical hanging scales [Max] > 50 kg – 350 kg	961-102	961-102R	105,-
Mechanical hanging scales [Max] > 350 kg – 1500 kg	961-103	961-103R	165,-
Mechanical hanging scales [Max] > 1500 kg – 3000 kg	961-104	961-104R	220,-
Mechanical hanging scales [Max] > 3000 kg – 6000 kg	961-105	961-105R	440,-
Mechanical hanging scales [Max] > 6000 kg – 12000 kg	961-106	961-106R	500,-

Force gauges, tensile force, prices for initial calibration and recalibration

Checking equipment	Initial calibration	Recalibration	Price excl. of VAT ex works
	Tensile force KERN	Tensile force KERN	€
Force gauges [Max] 300 N, 400 N, 500 N (DAkS Calibration)	963-161	963-161R	250,-
Force gauges [Max] ≤ 500 N	961-161	961-161R	135,-
Force gauges [Max] > 500 N – 2 kN	961-162	961-162R	165,-
Force gauges [Max] > 2 kN – 10 kN	961-163	961-163R	225,-
Force gauges [Max] > 10 kN – 20 kN	961-164	961-164R	350,-
Force gauges [Max] > 20 kN – 50 kN	961-165	961-165R	520,-
Force gauges [Max] > 50 kN – 120 kN	961-166	961-166R	940,-

Force gauges, compression force, prices for initial calibration and recalibration

Checking equipment	Initial calibration	Recalibration	Price excl. of VAT ex works
	Compression force KERN	Compression force KERN	€
Force gauges [Max] > 50 N – 500 N	961-261	961-261R	135,-
Force gauges [Max] > 500 N – 2 kN	961-262	961-262R	165,-
Force gauges [Max] > 2 kN – 5 kN	961-263	961-263R	225,-

Force gauges, tensile and compression force, prices for initial calibration and recalibration

Checking equipment	Initial calibration	Recalibration	Price excl. of VAT ex works
	Tensile force/ Compression force KERN	Tensile force/ Compression force KERN	€
Force gauges [Max] > 50 N – 500 N	961-361	961-361R	245,-
Force gauges [Max] > 500 N – 2 kN	961-362	961-362R	300,-
Force gauges [Max] > 2 kN – 5 kN	961-363	961-363R	405,-

Measuring instruments, prices for initial calibration and recalibration

Checking equipment	Initial calibration	Recalibration	Price excl. of VAT ex works
	KERN	KERN	€
Hardness testing devices in accordance with Leeb tests (Type D)	961-131	961-131R	120,-
Coating thickness gauges 0 µm – 2000 µm (Ferro or NonFerro)	961-110	961-110R	120,-
Coating thickness gauges 0 µm – 2000 µm (Ferro and NonFerro)	961-112	961-112R	170,-
Ultrasonic material thickness testing devices 25 mm – 300 mm	961-113	961-113R	120,-

A

Accuracy classes for test weights

E, F, M → *Error limit classes*

Adjusting of measurement equipment

Precise setting of a measurement value via a professional intervention in the measurement system.

Adjusting the weighing range of a balance



Either with the external test weight via **the adjusting program CAL**, or with the **internal automatic adjustment resp. adjusting switch**. It is necessary with variations in temperature, a change of environmental conditions, change of location, etc. **Recommended as a daily check routine.**

Alibi memory

For weighings where verification is mandatory, and which are to be analysed and processed by a PC (e.g. printing out a packing list using a PC instead of a printer connected directly to the balance) electronic archiving is required by the metrological authorities by a verifiable data memory which cannot be manipulated.

Alibi memories from KERN fulfil this requirement. They are for paperless archiving of weighing results. For KERN products the alibi memory is fitted inside the balance, right between where the weight is determined and the output to the PC.

All data transferred to the PC is stored with date, time and all important weights for at least three months. These stored data strings can be displayed on the balance at any time. The data in the alibi memory can be deleted, but not changed.

Application accuracy

Allowance for measuring uncertainty during practical use of a balance. Is given in the appendix to the DKD calibration certificate.

ATEX

Derived from **AT**mosphere **EX**plosibles. (explosive atmosphere). A synonym for EU guidelines, which controls the quality and use of equipment in hazardous industrial environments, where there is explosion danger, e.g. by handling of flammable substances, which are present in high concentrations in the form of gas, mist, vapour or dust. See also 94/9/EC as well as 199/92/EC.

B

Balances which are verified/not approved for verification

Metrologically almost identical. For verified balances certain details are regulated by law, e.g. software changes and additional markings.

C

CAL

Adjusting the balance is triggered by using the CAL key on the key pad or on the touch display of the display device or the CAL menu option. This will guarantee the consistent high accuracy of the balance.

Calibration Certificate DKD/DAkkS



See product group 18 "Calibration service"

Calibration of measurement equipment:

determination of the precision of a measurement value without intervention in the measurement system. Example: to check a balance you load a → **test weight upon it**. The term "Calibrating" was formerly also used for → **Adjusting**.

Calibration or verification



DAkkS-Calibration is possible for every balance in perfect condition. DAkkS calibration is a private service monitored by the state for ensuring high quality requirements according to ISO 9000ff and others, e.g. in production or research. **M Verifying** is only possible for type-approved balances marked with the green **M**

→ **Verification**

Conformity assessment

Procedure for confirming warranted characteristics in accordance with recognised rules. For balances this relates to verification.

Conformity declaration from the manufacturer

The manufacturer declares that the product fulfils the applicable EU directives. With electronic balances this is always in conjunction with the CE mark.

Control of measuring equipment in the QM system in conjunction with quality standards

An organisation certified to a quality standard such as DIN/EN/ISO 9000 ff. e.g. a production plant is obliged to adhere to a defined quality standard within the framework of its quality management system. To do this, it is imperative to have a measurement equipment which is working accurately. DIN/EN/ISO 9001, December Edition 2008 states in section 7.6 "Guidance of monitoring and measurement equipment", that measurement equipment must be calibrated is defined intervals and before use. The measurement devices and measurement standards needed to do this must:

- be traced back to international or national standards. (→ **Traceability to the National Standard**)
- their uncertainty of measurement must be known
- they must be marked with a clear identification

- the test must be documented

The → **DAkkS calibration** fulfils all these requirements.

Conventional mass of weights

The problem is the air movement, which makes the weight appear lighter. In order to avoid this „distortion“ in daily use, all weights are adjusted to the unit specifications given in R111, e.g. it is accepted that: material density of the weights is 8000 kg/m³, air density is 1.2 kg/m³ and measuring temperature is 20°C.

Counting resolution

The counting resolution is calculated in points from the ratio of the weighing range [Max] divided by the smallest part weight. It is a statement of counting accuracy.

D

DAkkS = German accreditation authority

See product group 18 "Calibration service"

Data interface



To connect the balance to a printer, PC, network or a second balance. Typical interfaces are, for example, RS-232, RS-485, USB, Bluetooth, LAN, Digital I/O, DUAL, LAN etc. The interface parameters can be set using the balance. The interfaces available are stated in the model description.

Density determination

One of the main areas of application for laboratory balances is determining densities, e.g. determining the specific weight of liquids and solids. To do this you will need a highly accurate precision balance and a density set. It is particularly convenient if the balance can calculate and display the density right away. It has become apparent that by means of weighing when in the process of determining the density of liquids and solids according to the buoyancy method particularly accurate results can be obtained (Archimedes' principle).

Density determination of liquids:

By means of measuring the buoyancy with a glass plummet immersed in the liquid to be measured

Density determination of solid bodies::

The density is the ratio of weight [g] : Volume [cm³]. The weight is derived by weighing the sample in air. The volume is determined from the buoyancy $A = \text{weight loss in [g]}$ of a sample, which is submerged in a liquid. The density $D \text{ [g/cm}^3\text{]}$ of this liquid must be known. The volume [cm³] is a result of $A : D$.

Applications:

- a) Pre-packaged goods control, whenever a product is sold according to its volume [cm³]. This volume is calculated with weight [g] : density [g/cm³].
- b) Materials analysis
- c) Density of porous materials

DMS = Strain gauge



An electrical resistor strip that is glued to an elastic deforming body made of aluminium. As the strain gauge is mechanically deformed its resistance value changes, allowing the measured value to be calculated.

Draught shield

Required for balances with → **Readout**
 $d \leq 1 \text{ mg}$, to avoid disturbing air movements.

Dual-range balance

As the load increases, the balance switches automatically to the next largest range, for both, weighing range [Max] as well as readout [d].

E

Error limit classes for test weights according to OIML R111

For further details, see product group 17
 "Test weights"

F

FACTORY

These options can only be carried out at KERN factory.

FORCE = Electromagnetic force compensation



A counterforce is created by means of a coil in a permanent magnet. This counterforce is the same as the load of the weight being measured on the scale and therefore equalising. The measured value is calculated via the change in the coil current.

G

GLP = Good Laboratory Practice

→ **ISO/GLP**

Gravitational acceleration

→ **Gravitational force**

H

HACCP

= Hazard Analysis and Critical Control Points (HACCP)

The HACCP concept is a preventative system, which is designed to guarantee the safety of foodstuffs EC regulation 852/2004 mandates the use of the HACCP concept for all companies which are involved in production, processing and sales of foodstuffs.

I

ISO 9000ff/DIN EN ISO 9000ff

Quality Management System in the form of a DIN Norm for quality assurance in a factory.

ISO calibration/ISO certificate = factory calibration certificate

Testing measurement devices for accuracy in accordance with a procedure which is recognised, but not accredited.

ISO/GLP record keeping



Quality Assurance Systems demands record keeping of weighing results and correct adjusting of the balance, giving details of date, time and balance identification. The easiest way to obtain this documentation is by means of a connected printer.

J

Junction Box

For connection and simple corner adjustment of several load cells.

L

Linearity/precision

Greatest deviation of the weight displayed of a balance with regard to the value of the respective test weight in terms of plus and minus across the whole weighing range.

M

Minimum load [Min]

Lower limit of the verifiable weighing range. Is marked on the verification mark. The function of the balance is also given below the minimum load.

Minimum sample weight

Indicates the smallest weight which can be determined, depending on the process accuracy required.

N

Notified body

Neutral and independent, predominantly government bodies, which are formally appointed by the EC. They are engaged in the field of verification for conformity evaluations and type-approval test within the scope of type approvals.

O

Optimisation of reference weight (when piece counting)

See product group 08 "Counting balances/Counting systems/Stocktaking scales".

P

Percentage determination



Example: Reference weight prior to drying:
 $50\text{g} = \text{balance display } 100\%$. After drying
 $40\text{g} = \text{balance display } 80\% \text{ absolute}$
 (dry mass) or $20\% \text{ relative}$ (humidity).

Permissible ambient temperature

Measurement errors are possible with readings on either side of the limits. With verified balances this is stated on the identification plate.

PLU (Price Look Up)

This refers to a data memory in price-computing retail scales for the base price of sales items.

PRE-TARE

Entering and saving a tare weight (e.g. container weight) through weighing or manual entry using the balance keypad before the actual weighing process. When you subsequently place the tare container on the balance, the balance will show zero immediately - saves time. Particularly useful e.g. for checking fill levels

Pre-packaging legislation (FPVO)

Ensures that pre-packed goods are filled correctly, for example, in food industry. The Weights and Measures Act governs the permissible weight tolerances.

Proof of compatibility

This documents the verification compatibility for combinations of weighing modules such as display devices, load cells and connecting elements.

R

Readout [d]

Smallest readable weight increment on a digital display.

Recalibration

periodic checking of the precision of measurement equipment/checking equipment (e.g. balances/weights) to control accuracy,

→ **Control of measurement equipment**

Reference weight (when piece counting)

See product group 08 "Counting balances/Counting systems/Stocktaking scales".

Reproducibility (standard deviation)

sequenced measure of conformity in repeated weighing (e.g. balances) subject to the same conditions. Mostly 1 d or less. Quality feature.

Resolution of a balance

The resolution is calculated from the weighing range [Max] divided by the readout [d], z. B. [Max] $420 \text{ g} : [d] 0.001 \text{ g} = 420,000 \text{ points}$. The resolution is a quality feature - the higher, the better.

S

SC-TECH = Single-Cell-Technology



→ **FORCE**. The load cell consists of a single aluminium block, which gives a very high measurement quality.

Semi-micro balance

Analytical balance with a readout [d] = 0,01 mg

Smallest part weight when counting

The smallest piece weight, which a balance can accept for piece counting. For the relevant model, enter "g/piece" in the product data table.

T

Taring, automatic (PRE-TARE)

When the tare pan is put in place, the balance immediately displays zero.

Taring, subtractive

The available weighing range of a balance is reduced by the value of the tare load. Example: weighing range of a balance Max 6000g, Tare (= container) 470g, available weighing range 5530g.

Test weight, external (previously calibration weight)



for adjusting or checking the balance accuracy → **Adjusting the weighing range**. The external test weight can be DAkkS calibrated at any time, even afterwards, see product group 18 "Calibration Service".

Test weight, internal



Like test weight external, but installed in the balance and powered.

T-FORK = Tuning fork principle

A resonating body (like a tuning fork) is electromagnetically excited, causing it to oscillate. The measured value is calculated via the change in frequency corresponding to the load of the weight being measured on the scale.

Totalising

Various individual weighings are added automatically to aggregate, e.g. all individual weighings of a batch.

Traceability to the National Standard

A pre-requisite for every perfect measurement is the validated comprehensive proof that the measuring equipment can be traced back to the international or national standards. In Germany the statutory binding standards are available from the PTB.

Type approval for balances

Strict process to test whether a balance fulfils the verification requirements. A balance can only be verified, if it has got a type approval from a notified body.

U

Uncertainty of measurement of a balance (= standard deviation)

Determined for each balance according to a precisely given test method and documented in the → **Calibration certificate**. It depends on various factors, both, internal and external. Uncertainty of measurement increases by a rising charge of the balance, see product group 18 "Calibration Service"

V

Verification

Verification, in accordance with the new terminology "Conformity assessment". Only balances with → **EC type approval** can be evaluated for conformity. These balances have an identification plate with the green → **M**. Verification is stipulated by the state and serves as consumer protection.

According to the EU directive 2009/23/EG, balances must be verified if they are used as follows:

- in commercial trade when the price of a commodity is determined by weighing.
- in the manufacture of pharmaceuticals in pharmacies and analysis in pharmaceutical and medical laboratories.
- for official purposes.
- in the production of prepackaging.
- in medical applications.

Every balance is tested by the metrological service and stamped with a verification mark. Its accuracy within the framework of permissible standard tolerances is thereby confirmed. EU verification applies to all member states of the EU.

Verification classes of balances



Class I – Analytical balance (precision balance),
Class II – precision balance,
Class III – industrial scale (commercial scale).

Verification of a balance with adjusting program CAL EXT

the adjusting program is sealed with an official mark after the verification. Thus the verification is only valid for the specific location of use.

→ Gravitational force

For the preparation of verification it is therefore necessary to advise the location of use and postcode.

See individual model details for the information as to whether verification can be carried out in the factory or at the location of use.

Verification of a balance with automatic internal adjusting CAL INT

the above restrictions in respect of the location of use do not apply, because the automatic internal adjusting works also after verification, therefore it is not sealed. In this case, verification does not depend on the location.

Verification validity for balances

Generally 2 years for all verification classes, for control balances generally 1 year, after expiry the balance has to be re-verified.

Verification value [e]

measure of the verification tolerance, depending on balance, mostly between 1 [d] and 10 [d]

→ Readout

W

Weighing range [Max]

is the working range of the balance. The balance can be loaded up to the specified upper limit.

Keyword index

A	
Accessories	52, 177-187, 206
Adiposity scales	see website
Alibi memory	7-8, 33, 41-43, 48, 50-51, 122, 120-121, 214
Analytical balances	44-53
Animal scales	19-22, 25-27, 30, 33-35, 38-39, 41-42, 46, 50, 63, 65, 66, 69-71, 82, 100-103, 107-113, 115, 114, 118-122, 125-139, 147-149, 161, 162, 168
Axle load scale	141-143
B	
Baby scales	see website
Bathroom scales	see website
Bench scales	60-71
Bluetooth/RS-232 converter	180
Body fat scales	see website
C	
Calibration	208-213
Calibration Service	208-213
Case, for transport	183
Carat balances	10, 17
Catalogues, Brochures, Flyer	2
Certificates, DKD/DAkKS	208-213
Chair scales	see website
Coating thickness gauges	see website
Control of checking equipment	208
Counting scales	86-103
Counting systems	97-103
Crane scales	163-168
D	
DAkKS/DKD	208-213
Density determination	17, 24, 33-35, 47, 114, 118-119, 183, 214
Display devices	144-153
Display, large	181, 185
Drive-through scale	137-139
Drying balance	53-59
E	
Ethernet/RS-232 converter	180
Explosion hazard	217
F	
Fiberglass filter	54-59
Floor scales	123-140
Foot switch	182
Force gauges	see website
G	
Glossary A-Z	214-216
Gravitation	213, 217
Grain balances	see website

H	
Hand grip dynamometer	see website
Handrail scales	see website
Hanging scales	159-168
Hardness tester	see website
Height rods	see website
Historiy KERN	219
Hydrostatic balances	17, 20-22, 24, 25-27, 29-31, 33-43, 45-51, 66, 69-71, 114, 118-122
I	
Industrial scales	60-176
Information	2-5, 214-217
Interface cable	179
Internet	218
Ioniser	52, 183
IP 65+ scales	76-82, 173, 174, 100-103, 110, 111, 115-117, 120, 121, 125-139, 147-153
ISO calibration	213
L	
Laboratory balances	11-59
Length measuring devices	see website
Load link balances	XXXX
M	
Mechanical balances (spring balances)	see website
Medical scales	see website
Moisture analysers	53-59
Microscopes, biological	see website
Microscopes, metalurgical	see website
Microscopes, polarisation	see website
Microscopes, stereo	see website
P	
Pallet scales	134-136
Pallet truck scales	154-158
Personal scales	see website
Pictograms	2
Platforms	150-153
Platform scales	104-122
Plummet, density determination	183
Pocket balances	9-10
Power supply adapter set	182
Precision balances	11-43
Pre-packaging legislation	169
Pre-packaging legislation, scale to meet with	169-171
Price computing scales	83-85
Printer	177-178, 184
Protective dust cover	52, 183

R	
Retail scales	83-85
Refractometers, analogue	see website
Refractometers, digital	see website
Recalibration	208-213
RS-232/Bluetooth converter	180
RS-232/USB converter	181
RS-232/Ethernet converter	180
RS-232/WLAN converter	180
S	
Sample plates, Aluminium	54-59
Semi-micro balances	48-51
Signal lamp	181, 185
Software	179, 184
Spring balances	see website
Stainless steel scales	72-82
Stocktaking scale	96, 97, 175
T	
Tare pan	183
Temperature calibration set	54-59
Tension Transducer	163, 164
Tensile force gauge	163, 164
Terminals	144-149
Test weights	188-207
Test service	208-213
Test stands	see website
Thickness gauges	see website
Touchscreen scales	7-8, 34-35, 41-43, 50-51, 70-71, 96, 97, 118-121, 170-171, 176
Transport case	182
Tweezers	208
U	
Underfloor weighing, accessories	15-17, 21-22, 24-27, 30-31, 33-43, 48-51, 69-71, 92, 94, 96, 97, 114, 118-122, 181
USB/RS-232-Adapter	181
V	
Verification	212
W	
Warranty	2
Weights	188-207
Weighing bridges	150-153
Weighing table	52, 183
Weighing beams	133, 152
WLAN/RS-232 converter	180

Sales conditions



All prices are valid as of January 1st 2016 until a new version of the KERN catalogue is released. In Europe, all prices do not include the applicable V.A.T.

At KERN there is no minimum order value. For orders less than € 15.00 there is no re-sale discount available. A minimum fee of € 15.00 (net) will be charged for orders less than € 15.00 (net).

Delivery Conditions: we supply ex works Balingen, e.g. the transport costs are invoiced. With our contract logistics partners we always offer you shipping at a good rate. When shipping to islands or other more distant areas, or areas which are difficult to access, the transport costs may possibly be higher, please ask for details. Any goods supplied remain KERN's property until complete payment for the goods sold has been received.



Delivery is usually via courier service.



When you see this symbol by truck, please ask for prices.

Extract from general terms and conditions:

Court of jurisdiction/Legal domicile: 72336 Balingen, Germany;
Commercial register N°: HRB 400865, AG Stuttgart;
Managing director: Albert Sauter, Martin Sauter.
For the full Terms and Conditions, please refer to the website.
www.kern-sohn.com/en/kern/agbs.html

Price changes and product changes are likely in individual cases, due to product modifications as well as error.

Sale or return: within 14 days of purchase. Not valid for order-specific adaptations such as special productions, cable extensions, special weights, etc. or test services such as calibration, verification, etc. Depending on the time and effort involved, there may be processing and storage costs, please ask for details.

Warranty: 3 years.

2 years for products with list price ≤ € 400.00

Does not apply to consumables such as batteries, rechargeable battery packs, etc.

Services



Free delivery: all orders from dealers via the KERN online shop with an order value over € 150.00 (list price) and parcel shipment, within the EU (except of MT, CY) with our parcel service (except pallet shipment) are delivered free of charge.

3 % web discount: Additional discount for dealer orders from the KERN online shop (only in combination with KERN e-invoice, please ask for details).

KERN DirectCash: The quick, secure COD procedure for protection against non-payment. With the KERN DirectCash COD system, you can safely deliver orders to end customers with unknown credit rating, with no risk of non-payment. Please request further details on this procedure.

Hire Purchase

Financing is available using KERN hire purchase - easy and convenient.

Hire Purchase gives you the option of purchasing any product from the range against a simple monthly installment. The product value is financed over the period of the agreement. On payment of the last installment, the ownership of the contract item automatically transfers from the contractor to the contractee.

The Hire Purchase Agreement can - if you so choose - be set for a period of between one and five years. This package includes the transfer of items as well as the guarantee for the entire transfer period.

Compared with buying the product, KERN hire purchase offers the advantage that the initial financial investment is largely unnecessary. This is particularly relevant when purchasing a number of products, for example when refitting a laboratory, a company department or a hospital ward. In addition the monthly installments constitute a direct cost and the item does not have to be capitalised by the purchaser.

After-Sales-Service



Repair service within 1 week at our plant in Balingen, transportation costs are additional. In urgent cases, if requested by customer, a replacement device will be provided until all repairs are completed; please ask.

Price reduction for a new device:

if repair costs exceed the current value of the defective device, a new device will be offered for a discount price. This offer is valid only up to 2 years after warranty expiration.

Spare parts service within 48 hours, transportation costs are additional.

Marketing support



KERN catalogues, brochures, branch prospectuses – your own personalised marketing tools

This catalogue and branch prospectuses are available free of charge. A neutral version of the catalogue, without the KERN address imprint, is also available free of charge for your marketing activities (200 pcs.), larger quantities on request.

On demand, your company logo and address can be printed on the back of the KERN catalogue free of charge (200 pcs.), larger quantities on request. In this way you have got your own individual marketing tool. The KERN catalogue and branch prospectuses are available in the following languages: DE, GB, FR, IT, ES.
For further details, see page 2.

Important notice



Explosion hazard or humidity

With the exception of the specially labelled models (ATEX), our balances are not suitable for rooms with a risk of explosion. Our models are also not suitable for rooms with a high level of air humidity (condensing). Please observe the applicable electrical regulations.

Earth's gravitational force

Electronic balances are subject to location regulations due to the earth's gravitational force. If location of use is changed, reverification and recalibration of the electronic balance is needed.
See the glossary, page 215 → **Adjusting**

KERN Pictograms

Internal adjusting: Quick setting up of the balance's accuracy with internal adjusting weight (motordriven).	Piece counting: Reference quantities selectable. Display can be switched from piece to weight.	Suspended weighing: Load support with hook on the underside of the balance.
Adjusting program CAL: For quick setting up of the balance's accuracy. External adjusting weight required.	Recipe level A: Separate memory for the weight of the tare container and the recipe ingredients (net total).	Battery operation: Ready for battery operation. The battery type is specified for each device.
Memory: Balance memory capacity, e.g. for article data, weighing data, tare weights, PLU etc.	Recipe level B: Internal memory for complete recipes with name and target value of the recipe ingredients. User guidance through display.	Rechargeable battery pack: Rechargeable set.
Alibi memory: Electronic archiving of weighing results, complying with the 2009/23/EC standard. For details see page 214	Recipe level C: Internal memory for complete recipes with name and target value of the recipe ingredients. User guidance through display, adjustment of recipe when dosages are exceeded, multiplier function, barcode.	Universal mains adapter: with universal input and optional input socket adapters for A) EU, GB B) EU, GB, USA C) EU, GB, USA, AUS
Data interface RS-232: To connect the balance to a printer, PC or network.	Mains adapter: 230V/50Hz in standard version for EU. On request GB, USA or AUS version available.	Power supply: Integrated in balance. 230V/50Hz standard EU. More standards e.g. GB, USA or AUS on request.
RS-485 data interface: To connect the balance to a printer, PC or other peripherals. High tolerance against electromagnetic disturbance.	Totalising level A: The weights of similar items can be added together and the total can be printed out.	Weighing principle: Strain gauges Electrical resistor on an elastic deforming body.
USB data interface: To connect the balance to a printer, PC or other peripherals.	Totalising level C: Internal memory for complete recipes with name and target value of the recipe ingredients. User guidance through display, adjustment of recipe when dosages are exceeded, multiplier function, barcode recognition.	Weighing principle: Tuning fork A resonating body is electromagnetically excited, causing it to oscillate.
Bluetooth* data interface: To transfer data from the balance to a printer, PC or other peripherals.	Weighing principle: Electromagnetic force compensation Coil inside a permanent magnet. For the most accurate weighings.	Weighing principle: Single cell technology Advanced version of the force compensation principle with the highest level of precision.
WLAN data interface: To transfer data from the balance to a printer, PC or other peripherals.	Percentage determination: Determining the deviation in % from the target value (100 %).	Verification possible: The time required for verification is specified in the pictogram.
Control outputs (optocoupler, digital I/O): To connect relays, signal lamps, valves, etc.	Weighing units: Can be switched to e.g. nonmetric units at the touch of a key. See balance model. Please refer to KERN's website for more details.	DAKkS calibration possible (DKD): The time required for DAKkS calibration is shown in days in the pictogram.
Interface for second balance: For direct connection of a second balance.	Weighing with tolerance range: Upper and lower limiting values can be programmed individually for e.g. dosing, sorting and portioning	Package shipment: The time required for internal shipping preparations is shown in days in the pictogram.
Network interface: For connecting the scale to an Ethernet network. With KERN products you can use a universal RS-232/LAN converter. See page 180	Hold function: (Animal weighing program) When the weighing conditions are unstable, a stable weight is calculated as an average value.	Pallet shipment: The time required for internal shipping preparations is shown in days in the pictogram.
Wireless data transfer: between the weighing unit and the evaluation unit using an integrated radio module.	Protection against dust and water splashes IPxx: The type of protection is shown in the pictogram. For details see the glossary. See page 72.	Warranty: The warranty period is shown in the pictogram.
GLP/ISO log: The balance displays the weight, date and time, regardless of a printer connection.	ATEX explosion protection: Suitable for use in hazardous industrial environments, in which there is explosion danger. The ATEX marking is specified for each device.	
GLP/ISO log: With weight, date and time. Only with KERN printers, see "Accessories", see page 177.	Stainless steel: The balance is protected against corrosion.	

KERN – measuring technology and testing services from a single source



Balances & Test service catalogue

Provides a complete overview of the KERN line of balances, test weights, and services, services such as verification, calibration, etc.

Medical scales catalogue

Complete line of medical scales, from infant scales to patient scales, chair scales and adiposity scales, as well as hand grip dynamometres, chemist's balances, and veterinary scales.

Microscopes & refractometers catalogue

Extensive range in the area of optical instruments, such as, for example, biological microscopes, stereo microscopes, metallurgical microscopes, polarisation microscopes as well as analogue and digital refractometers.

SAUTER measuring equipment catalogue

Test instruments for industry and commerce, such as force, coating thickness, material thickness and calibration service.



KERN DAKkS calibration service brochure

Detailed information on topics pertaining to the calibration and verification of balances, test weights, and force measuring devices.



KERN flyer Special offers

Compact overview of our bestselling products – just the balances/microscopes your customers need! Can be customised to suit your requirements.



The gnome guide

Travel report from KERN, the famous scientific gnome, who travelled all over the world, in order to illustrate the physical law of gravitational force. Ideal for use in school education – please request, it's free of charge.



170 years of KERN

Interesting and readable overview of the history of the origins of Southern German balance manufacturing, as well as the company history, which stretches right back to 1770 – please request, it's free of charge.

Your advantages

- 1 Quick Delivery**
Items in stock are sent the same day if orders are placed before 1:00 pm (valid for parcel service delivery within the EC).
- 2 Price performance ratio**
KERN scales are always an inexpensive alternative. They are durable, uncomplicated and easy to place into operation.
- 3 Direct dispatch**
of ordered goods to your customer is available, with personalised delivery note if desired (please ask), invoice will be issued to you (third party business).
- 4 3 years warranty**
Items under € 400,- : 2 years
- 5 No stock-keeping necessary.**
KERN does the warehousing for you.
- 6 Sale or return**
within 14 days of purchase.

Tradition and innovation for more than 170 years

An independent family business, KERN since already 7 generations is synonymous with quality and reliability in customer service.

1844 KERN is founded – precision balances are produced	1863 A proud Gottlieb Kern with his staff	1880 Pharmaceutical balance with Aesculap	1923 Inflation – KERN wages are paid with self printed currency	1980 The electronic balance ousts mechanical devices
1994 Accredited DKD laboratory (ISO 17025)	2000 New premises in Balingen	2002 Existing QM system certification in accordance with DIN EN ISO 9001:2000 standards	2007 Approval for the manufacture of medical products (DIN EN 13485 and 93/42/EEC)	2008 Authorisation for initial verification by the manufacturer (2009/23/EC)
2009 Approval for the manufacture and sale of height rods (DIN EN 13485 and 93/42/EEC)	2012 Verification point for non-automatic balances and test weights. New customer portal www.kern-sohn.com goes live	2014 Expansion of the product range to include optical instruments (microscopes and refractometers)	2015 Inauguration of Ziegelei 2.0 with computer-controlled high-bay warehouse	

Our Tip

Come to see the Museum of scale and weight ...

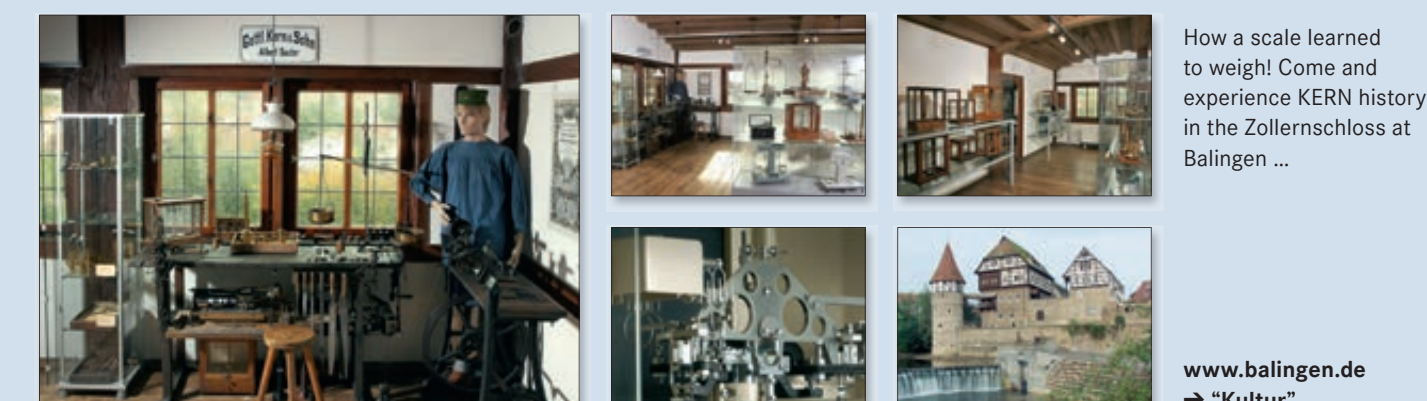

How a scale learned to weigh! Come and experience KERN history in the Zollernschloss at Balingen ...

www.balingen.de
→ "Kultur"